

OVER 26 PAGES ON HIGH FIDELITY

RADIO & TELEVISION NEWS

MARCH
1957
35 CENTS

World's Leading Electronics Magazine

**WHY DO AMPLIFIERS
SOUND DIFFERENT?**

**LOUDSPEAKER DAMPING
AND TONAL RESPONSE**

**BEFORE YOU CALL FOR
SERVICE—CHECK YOUR
OWN HI-FI SYSTEM**

**TURNTABLE
SPEED PROBLEMS**

**A TRANSISTOR
CURRENT-GAIN
TEST SET**

**THE CONSONANT
AMPLIFIER-LIMITER**

COVER STORY
(See Page 95)



Use
RAYTHEON
All-Set
TV & RADIO
TUBES

RAYTHEON

RAYTHEON

for all set replacement work!

You'll save yourself trouble if you standardize on Raytheon "All-Set" Tubes for replacement work.

Here's why:

Raytheon "All-Set" Tubes are designed to give perfect service in many makes and models of receivers because Raytheon sells Tubes to almost

every set manufacturer. To satisfy the many and varying needs of so many manufacturers, these tubes must combine top quality performance and dependability. This successful combination makes Raytheon "All-Set" Tubes tops for replacement.

Always use Raytheon "All-Set" Tubes to satisfy your "all-set" customers.

TV-Radio service is your business . . . serving you is ours



RAYTHEON MANUFACTURING COMPANY

Receiving and Cathode Ray Tube Operations

Newton, Mass. • Chicago, Ill. • Atlanta, Ga. • Los Angeles, Calif.

Raytheon makes { Receiving and Picture Tubes, Reliable Subminiature and Miniature Tubes,
 all these { Semiconductor Diodes and Transistors, Nucleonic Tubes, Microwave Tubes.



Excellence in Electronics

Learn Radio Television

Servicing or Communications

by Practicing at Home

in Spare Time

N. R. I. SENDS kits with which you practice building circuits common to Radio and TV sets. You LEARN-BY-DOING to locate Radio-TV troubles. As part of N. R. I. Servicing Course, you build Vacuum Tube Voltmeter and AC-DC receiver. Use VTVM to conduct experiments, earn extra money fixing sets in spare time.

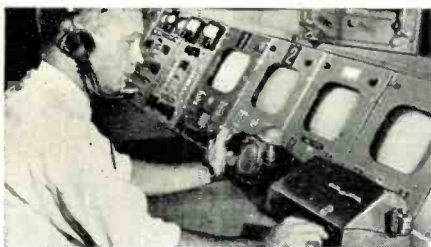
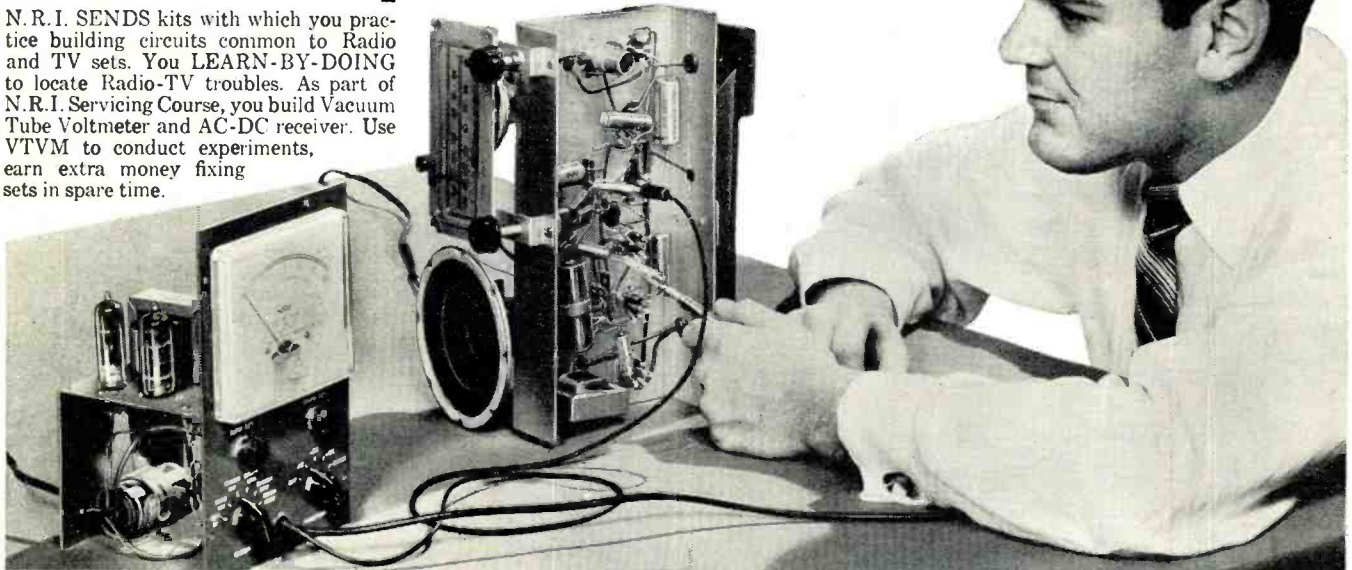

RADIO-TV BROADCASTING (see above) offers important positions as Operators and Technicians. RADIO-TV SERVICING Technicians (see below) needed in every community. Their services are respected, their skill appreciated.



Fast Growing Field Offers You Good Pay, Success, Bright Future



J. E. SMITH
Founder

Bigger than ever and still growing fast. That's why Radio-TV has special appeal to ambitious men not satisfied with their job and earnings. More than 4,000 Radio and TV stations. More than 150 million home and auto Radios, 40 million TV sets. Color TV promises added opportunities.

Trained man, there are good jobs, bright futures in Radio-TV Servicing or Broadcasting. Training PLUS opportunity is the ideal combination for success. So plan now to get into Radio-TV. The technical man is looked up to. He does important work, gets good pay for it. Radio-Television offers that kind of work. NRI can supply training quickly, without expense of going away to school. Keep your job while training. You learn at home in your spare time. NRI is the OLDEST and LARGEST home study Radio-TV school. Its methods have proved successful for more than 40 years.

Added Income Soon - \$10, \$15 a Week in Spare Time

Soon after enrolling, many NRI students start to earn \$10, \$15 a week in spare time fixing sets. Some pay for their training and enjoy extra luxuries this way. Some make enough to start their own Radio-TV shops. NRI training is *practical*—gets quick results. Easy to understand, well illustrated lessons teach you basic principles. And you LEARN-BY-DOING by practicing with kits of equipment which "bring to life" things you study.

Find Out What NRI Offers

NRI has trained thousands for successful careers in Radio-TV. Study fast or slow—as you like. Diploma when you graduate. Mail coupon now. Paste it on a postcard or mail in envelope. ACTUAL LESSON FREE. Also 64 page catalog that shows opportunities, shows equipment you get. Cost of NRI courses low. Easy terms. NATIONAL RADIO INSTITUTE, Dept. 7CE Washington 9, D. C.

N.R.I. TRAINED THESE MEN FOR SUCCESS



"I was repairing Radios by 10th lesson. Now have good TV job." M. R. LINDEMUTH, Fort Wayne, Ind.



"Doing spare time repairs on Radio and TV. Soon servicing full time." CLYDE HIGGINS, Waltham, Mass.

"I had a successful Radio repair shop. Now I'm Engineer for WHPE." V. W. WORKMAN, High Point, N. C.



"There are a number of NRI graduates here. I can thank NRI for this job." JACK WAGNER, Lexington, N. C.



VETE ANS Approved Under G. I. Bills

RADIO & TELEVISION NEWS is published monthly by Ziff-Davis Publishing Company, William B. Ziff, Chairman of the Board (1946-1953), at 64 S. Lake St., Chicago 1, Ill. Entered as second-class matter July 21, 1948, at the Post Office, Chicago, Ill., under the act of March 3, 1879. Authorized by Post Office Department, Ottawa, Canada, as second-class matter. SUBSCRIPTION RATES: Radio & Television News—one year U. S. and possessions, and Canada \$4.00; Pan-American Union countries \$4.50; all other foreign countries \$5.00.

SEND FOR BOTH FREE

National Radio Institute

Dept. 7CE Washington 9, D. C.

Mail me Sample Lesson and 64-Page Catalog FREE. (No salesman will call. Please write plainly.)

Name _____ Age _____

Address _____

City _____ Zone _____ State _____

Approved Member National Home Study Council

The ABC's of SERVICING

Job and Career Opportunities for RADIO-TV TECHNICIANS

Publisher
OLIVER READ, D.Sc., W1EYI
Editor
WM. A. STOCKLIN, B.S.
Technical Editor
MILTON S. SNITZER
Service Editor
SIDNEY C. SILVER
Associate Editor
P. B. HOEFER
Assistant Editor
J. JUSTER
Television Consultant
WALTER H. BUCHSBAUM
Art Editor
HERBERT ASCHER
Art and Drafting Dept.
J. A. GOLANEK
W. K. VAHSING
JAMES A. ROTH
Advertising Director
L. L. OSTEN
Advertising Manager
MURRAY GOLDMAN
Midwest Adv. Manager
JOHN A. RONAN, JR.
Western Adv. Manager
JOHN E. PAYNE



COVER PHOTO: Helen Merrill, talented young recording star, "audits" her own performance on a Presto playback unit at the Masque Sound & Recording Corp. studios. The "approved" version will be pressed on EmArcy label discs. (Ektachrome by Irving Kaufman)

ZIFF-DAVIS PUBLISHING COMPANY

President
B. G. DAVIS
Vice-President
H. J. MORGANROTH
Vice-President
M. H. FROELICH
Vice-President & Circulation Dir.
M. MICHAELSON
Secretary-Treasurer
G. E. CARNEY
Art Director
AL GRUEN

BRANCH OFFICES

CHICAGO 111
 64 E. Lake St., RM. 2140
 LOS ANGELES 114
 212 W. 7th St., Room 4121, Tel. 5542

*First in radio-
 television-audio-electronics*

Average Net Paid Circulation 258,790

Radio News Trademark Reg. U. S. Pat. Office • Television News Trademark Reg. U. S. Pat. Office.



CONTENTS

MARCH, 1957

EDITORIAL—INDUSTRY NEWS

For the Record.....	O. Read	8
Spot Radio News.....	Washington Correspondent	16
New TV Grants Since Freeze Lift.....		16
Birth of the Electron Tube Amplifier.....	F. B. Llewellyn	43
Calendar of Events.....		71
Alaska Telephone Cable Opened for Use.....		86
Cover Story.....		95

HIGH FIDELITY AND AUDIO

Before You Call for Service—Check Your Own Hi-Fi System.....	Warren Philbrook	35
Why Do Amplifiers Sound Different?.....	Norman H. Crowhurst	40
Certified Record Revue.....	Bert Whyte	48
The "Tiny Mite" Loudspeaker Enclosure.....	Abraham B. Cohen	52
Adding an FM Tuning Indicator.....	Herman Burstein	59
Loudspeaker Damping and Tonal Response.....	George L. Augspurger	62
A 3-Channel Amplifier.....	Kenneth W. Beth	65
New Hi-Fi—Audio Equipment.....		88
Progress in FM Multiplexing.....	Herman Burstein	107

SERVICING

Television-Radio

Problems in Metropolitan TV Reception.....	Simon Holzman	38
Are Your Electrolytics Leaky?.....	Ben Crisses & David Gnessin	42
Turntable Speed Problems.....	Charles Garrett	46
New Long-Life TV Rectifier.....		57
The Service Industry and Public Relations.....	William Leonard	58
The Outlook for Color TV.....	Robert B. Gary	64
Mac's Service Shop.....	John T. Frye	70
Save that Capacitor.....	Jack A. Jones	111
Unusual TV Circuit Troubles.....	Richard Blitzer	118
Muntz TV Hints.....	R. A. Hunholz	120
TV Lead-in Serves as S.W. or B.C. Band Antenna.....	Paul Falk	122
Antenna News.....		154
Service Industry News.....		160

Test Equipment

A Transistor Current-Gain Test Set.....	Carl David Todd	54
More Jobs for the A.C. V.T.V.M.....	Rufus P. Turner	69
New Tube Tester Data.....		152

AMATEUR AND COMMUNICATIONS

The Consonant Amplifier-Limiter.....	Donald B. Daniel, W5KYO/6	49
--------------------------------------	---------------------------	----

ELECTRONIC CONSTRUCTION

Circuit Reliability.....	Paul Penfield, Jr.	114
Transistorized Superhet.....		148

DEPARTMENTS

Within the Industry.....	30	Sales Aids.....	157
What's New in Radio.....	136	Technical Books.....	163
Manufacturers' Literature.....		166	



ZIFF-DAVIS PUBLISHING COMPANY
 WILLIAM B. ZIFF (1898-1953) FOUNDER
 Editorial and Executive Offices
 366 Madison Ave., New York 17, N. Y.
 MU 7-8080

VOLUME 57 • NUMBER 3



Member
 Audit Bureau of
 Circulations

Copyright © 1957 by Ziff-Davis Publishing Company. All rights reserved.

SUBSCRIPTION SERVICE. All communications concerning subscriptions should be addressed to Circulation Dept., 64 E. Lake St., Chicago 1, Ill. Subscribers should allow at least four weeks for change of address. Include your old address as well as new—enclosing, if possible, an address label from a recent issue of this magazine.

CONTRIBUTIONS: Contributors are advised to retain a copy of their manuscripts and illustrations. Contributions should be mailed to the New York Editorial Office and must be accompanied by return postage. Contributions will be handled with reasonable care, but this magazine assumes no responsibility for their safety. Any copy accepted is subject to whatever adaptations and revisions are necessary to meet the requirements of this publication. Payment covers all author's, contributor's, and constant's rights, title, and interest in and to the material accepted and will be made at our current rates upon acceptance. All photos and drawings will be considered as part of the material purchased.

RADIO & TELEVISION NEWS

**DeVry Tech Can Prepare You
in Spare Time at Home**

To Enter the **Big Opportunity Fields of**

Automation Electronics

**What a
DeVry Tech
Diploma
Meant to
These Men:**



G. F. Beane,
West Virginia, was a truck driver. He took the DeVry Tech Training Program, and is now a technical electronics sales representative.



Edward Hahn,
Illinois. Was a laborer; now an electronics project engineer with Televison, Inc. DeVry Tech training helped him prepare for his present position.



Nick Barton,
Illinois, came directly from high school to DeVry Tech. Now has his own service shop, and tells us he is "literally snowed with work."



George D. Crouch,
California, was a retail store clerk. He took the DeVry Program, and today has his own service business.

Plus...

RADAR

GUIDED MISSILES

TELEVISION-RADIO

COMMUNICATIONS

INDUSTRIAL ELECTRONICS

COMPUTERS

YOUR OWN SERVICE SHOP

**No Previous Technical Experience or
Advanced Education is Required**

Few men realize that they can successfully prepare in their spare time at home for good-pay jobs, not only in Automation Electronics—but Guided Missiles, Radar, Communications, Micro-Waves, Computers and Industrial Electronics.



DeVry Tech, with its modern training laboratories in both Chicago and Toronto, with its 26-year record of successfully preparing men for better jobs in the field of Electronics, will tell you free, without cost or obligation, how they may help you as they have helped many others. Fill out coupon below NOW—let us give you all the facts!

In addition to all the other phases of Electronics, Automation Electronics, the modern system through which office and factory machines almost run themselves, can help provide you with a more interesting and brighter future without interfering with your present job.

Find out how you may prepare to fit into this fast-growing opportunity field. Mail coupon NOW!

GET A SAMPLE LESSON FREE!

See for yourself how DeVry Tech trains you for real opportunities in Electronics. We'll also give you a free copy of an interesting booklet, "Electronics and YOU."

"One of North America's Foremost Electronics Training Centers"



Accredited Member of National Home Study Council

DEVRY TECHNICAL INSTITUTE

CHICAGO 41, ILLINOIS

FORMERLY

DEFORREST'S TRAINING, INC.



LIVE-WIRE Employment Service

DeVry Tech's Placement Department is in contact with some of the best-known employers in the Electronics field. The service is free to all graduates — and DeVry Tech's record in helping to place men has been outstanding.



DRAFT AGE?

We have valuable information for every man of draft age; so if you are subject to military service, be sure to check the coupon.

DeVry Technical Institute

4141 Belmont Ave., Chicago 41, Ill., Dept. RN-3-N

Please give me FREE Sample Lesson and your booklet, "Electronics and YOU," and tell me how I may prepare to enter one or more branches of Electronics as listed above.

Name _____ Age _____

Street _____ Apt. _____

City _____ Zone _____ State _____

Check here if subject to military training.

DeVry Tech's Canadian Training Center is located at 626 Roselawn Avenue, Toronto 12, Ontario 2003

RCA CUSTOM CONVERTIBLE SPEAKER SYSTEMS

hi-quality . . . hi-fidelity . . . anywhere and any way you like it!

Soft and sweet or loud and lively . . . in your den or in your living room, RCA CUSTOM CONVERTIBLE SPEAKER SYSTEMS offer *the finest in sound satisfaction.*

Buy with confidence! RCA CUSTOM CONVERTIBLE SPEAKER SYSTEMS, through exclusive RCA bottom-porting, are

readily convertible for use as INFINITE Baffle . . . Bass Reflex . . . Corner Driver . . . to suit your room acoustics, and your personal taste. Custom-built appearance is readily obtainable . . . panels and grill cloths can be removed and interchanged easily for matching or contrasting effects.

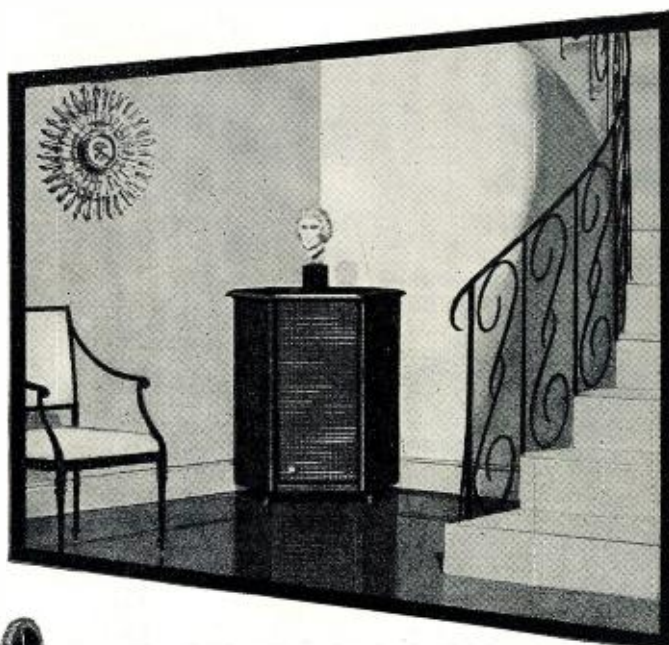
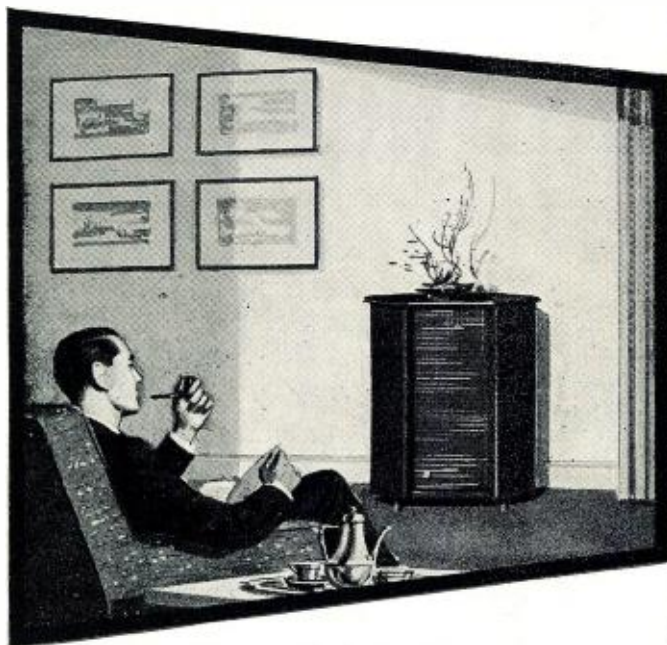

RCA 501S1 Biaxial Speaker—compares with models two or three times the price! Features 14.5 ounce Alnico-V magnet and 8-ohm voice coil. Its 12-inch woofer employs



Olson-developed foam damping ring; 3-inch tweeter is mounted off-axis to minimize crossover interference; high frequency response extends beyond 18,000 cps.
Suggested User Price (optional) \$33.50

RCA 502S1 Direct Radiator Speaker—outstandingly smooth, unsurpassed in its frequency range to 16,000 cps. Features same construction as 501S1 and incorporates



medium-weight curved cone for smoothness, range, damping, and sensitivity to equal sound pressure of higher power speakers using double the power input.
Suggested User Price (optional) \$25.25

RCA Enclosures—Beauty in cherry or blonde cabinetry, the solid Honduras Mahogany will enhance room decor with the expensive look and feel of fine woods. Built for a lifetime of use, RCA enclosures feature mortise-and-tenon joints, glue-block

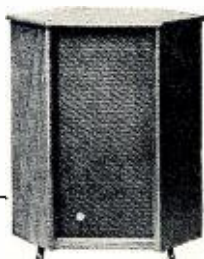

reinforcements and wood-screw clamping. For 12-inch speakers.
Suggested User 300W1 Cherry \$69.95
Price (optional) 301W1 Blonde \$74.50
301X1 Adapter Panel—converts 12-inch enclosures for use with 8-inch speakers.
Suggested User Price (optional) \$2.45



RADIO CORPORATION of AMERICA

COMPONENTS DIVISION

CAMDEN, N. J.

RCA SPEAKERS FOR TV • RADIO • PHONOGRAPH • HIGH FIDELITY • PUBLIC ADDRESS • AT RCA DISTRIBUTORS EVERYWHERE!

Why Guess? There's a Quick, Sure Way to Find TV Set Troubles

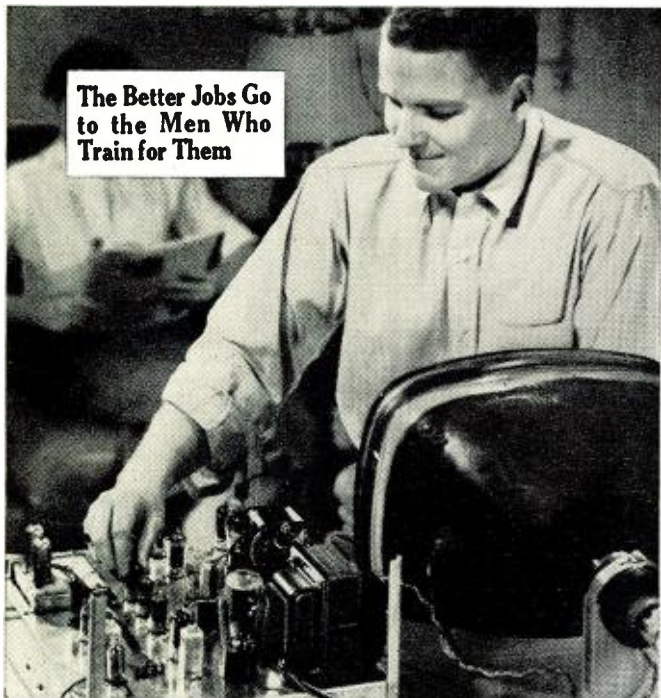

The Better Jobs Go to the Men Who Train for Them

NEW ALL-PRACTICE COURSE Shows How top TV servicemen fix ANY MAKE or model

Home Training includes 17" Picture Tube, components for a TV Receiver, Scope, Signal Generator, HF Probe, all for introductory price under \$200 on easy terms

PUT YOURSELF IN THIS PICTURE, experimenting at home with equipment we furnish, getting set to go places in TV servicing. Speed in servicing TV sets means stepped up earnings, greater security for you.

ACQUIRE SUPERIOR SKILLS AT HOME IN SPARE TIME

TV Servicing . . . real, professional TV Servicing, pays good money to men with specialized knowledge and training. The exciting, expanding TV industry offers more than just good jobs. It offers success, a career to men qualified to render an essential community service.

Be one of these experienced TV Servicemen. NRI's new course is 100% learn-by-doing, practical training. We supply all the equipment plus comprehensive manuals covering a thoroughly planned program of practice. You learn how experts diagnose TV receiver defects quickly. You learn the causes of defects . . . audio and video . . . accurately, easily. And you learn how to fix them.

ALL LEARN BY DOING

You do more than just build circuits. You get experience aligning TV receivers, isolating complaints from scope patterns, eliminating interference, use germanium crystals to rectify the TV picture signal, adjust the ion trap and dozens of other professional TV Servicing techniques.

Many fellows "go around in circles" trying to isolate TV receiver defects. Don't guess! Learn professional techniques. Take this training now. If you want to go places in TV servicing

you will act quickly to find out what you get, what you practice and how you can advance with better practical knowledge through NRI's new course in Professional Television Servicing. Accept this personal invitation to get a free copy of our booklet which describes this training in detail. Mail the coupon now. Remember, with this course you keep right on working, keep right on earning at your job while you learn through actual practice at home in your spare time.

UHF AND COLOR CREATE GROWING OPPORTUNITIES

To cash in on the present UHF and the coming Color TV boom you'll need the kind of knowledge and experience this Professional Television Servicing Course gives you. There

is no other training like this. Here, condensed into a few months of training at home, is everything that TV servicemen learn in months, even years of bench work. You get practice installing front-end channel selector strips in modern UHF-VHF receivers. You learn UHF servicing problems and their solution. Mail the coupon below. Discover how this new course meets the needs of the man who wants to get ahead in TV Servicing.

NOT FOR BEGINNERS

NRI's Professional All-Practice Television Servicing Course is for men with some knowledge of Radio and TV fundamentals but who need intensive, practical training and actual experience with TV circuits and professional servicing techniques to be self-reliant, confident, expert TV servicemen. Get this book FREE and judge for yourself how NRI's course will further your ambition to reach the top in TV servicing. Mail the coupon . . . there is no obligation . . . and it can open the door to a better career for you. Address: National Radio Institute, Dept. 7CET, Washington 9, D. C.

MAIL THIS NOW



NATIONAL RADIO INSTITUTE, Dept. 7CET
Washington 9, D. C.

Please send my FREE copy of "How to Reach the Top in TV Servicing." I understand no salesman will call.

Name Age

Address

City Zone State

Approved Member, National Home Study Council

KLEIN

THE THRILL THAT
ONLY GOOD TOOLS
CAN GIVE



The radio ham, serviceman or designer knows that the most important tools in his kit are Klein Pliers—long nose, oblique cutters, side cutters.

The quality of the work you do depends in no small measure on the quality of the tools you use. Your reputation as a craftsman is protected when your pliers carry the Klein trademark.



100 years of service to linemen, electricians and industry is back of this new Pocket Tool Guide No. 100. A copy will be sent to you upon request, without obligation.

Mathias **KLEIN** & Sons
Established 1857 Chicago, Ill., U.S.A.
7200 McCORMICK ROAD • CHICAGO 45, ILLINOIS

For the RECORD.

TELEVISION BOWS TO TV

NEXT month will find a slight change in the title of this magazine resulting from the acceptance (or preferred use) of "TV" over "Television." In its infancy, the transmission and reception of video signals was always known as television; accordingly, we altered our title in 1949 from RADIO NEWS to RADIO & TELEVISION NEWS. In the interests of uniformity (or simplification) we have felt that the use of the abbreviation for television would be more suited to our title and logo.

Accordingly, our new title beginning next month will be RADIO & TV NEWS. The new cover, which we have illustrated, will be wrapped around an outstanding issue. The impressive service bench shown was designed by *G-E* experts for utility and the efficient use of test equipment required in video servicing. The test equipment shown on the cover totals about \$1500 in cost. Considerable savings have resulted from the use of several instrument kits. In addition, some of the equipment shown is definitely in the lowest price range. The above figure does not include the cost of the bench, but it does represent a practical selection of components needed for the efficient servicing of the color set. Complete plans will be found in the April issue for the construction of the bench. The greater part of the equipment shown is also required for the efficient servicing of monochrome receivers.

This same issue will discuss various generators required in TV servicing, as well as a wealth of other informative material, such as up-to-date data on new 1957 auto radios, and a complete discussion of bottlenecks in TV service. Another article will deal with techniques and applications of fault analysis, and the same issue will also reveal many design innovations in the new *G-E* large screen color sets.

Another feature, under the title "The Case for the CRT Tester-Reactivator," will describe how this instrument has helped the technician save time, eliminate doubts in troubleshooting, and effect the rapid repair of certain picture tube defects heretofore considered unfeasible.

Other articles of great interest to service technicians are included, and a report under the title, "Upgrading and Accrediting Technicians" by Paul B. Zbar, director of the RETMA TV Training Program, tells how a training program developed by RETMA was used as a springboard in a plan to certify the qualifications of the service technician. Bob Middleton, prominent TV engineer, analyzes questions most frequently addressed to manufacturers of the oscilloscope, and Bob Eldridge in his article, "Facing the Phase Detector," explains what goes on in this popular horizontal control circuit—long a bug-a-boo to the

service technician. It shows how you can save a great deal of time in pinning down elusive horizontal instability.

Dealers who are having trouble keeping up with the bewildering number of new tube types being released for use in home electronic equipment will welcome the tube inventory check list. More than two hundred of the most frequently used types are listed and rated according to popularity, as a guide to how

many of which types should be kept in stock.

These special items, of course, are in addition to the regular features of interest to technicians, such as "New Tube Tester Data," "Service Industry News," and "Mac's Service Shop."

These are only a few of many outstanding articles you will find next month within our new cover. We hope you will like the change. . . O. R.



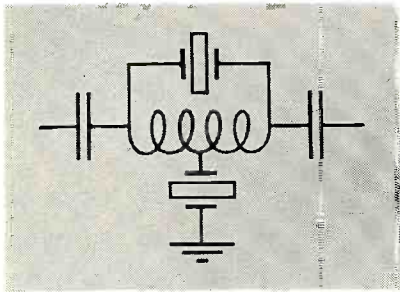

*From this exclusive HIGH
FREQUENCY filter originates
the cleanest signal on the air!*

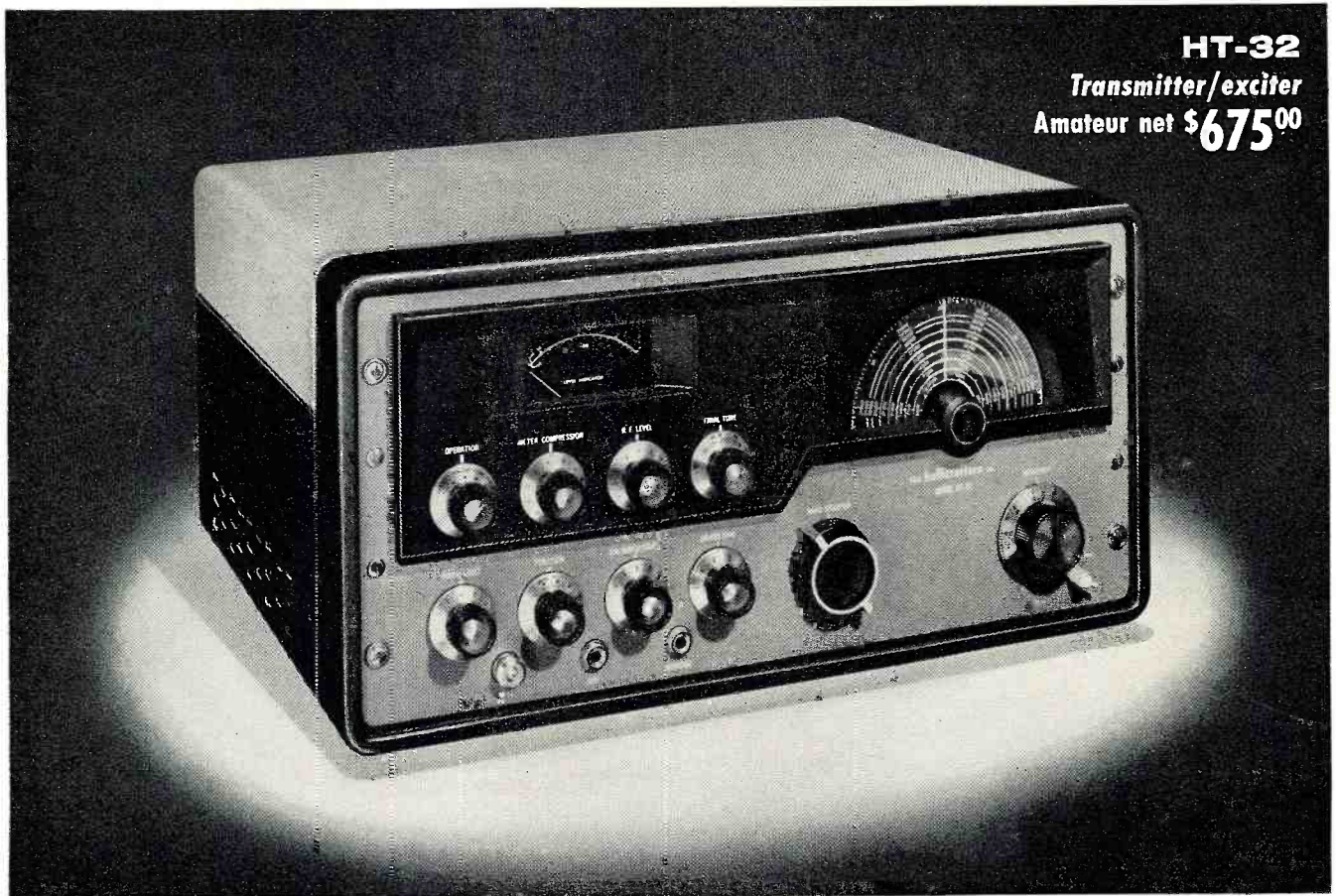

HT-32
Transmitter/exciter
Amateur net \$675⁰⁰

**Hallicrafters new HT-32 transmitter features
5.0 mc. quartz crystal filter... new bridged-tee
modulator... high stability... gear-driven V.F.O.**

• Forget your old ideas about SSB signal clarity! The HT-32 establishes *entirely new standards* with two major achievements of the world famous Hallicrafters laboratories—yours exclusively in the HT-32:

1. **5-0 mc. quartz crystal filter.** Result of a 3-year research program, the crystal filter system now is commercially practical at *high frequencies*. System cuts unwanted sideband 50 db. or more!
2. **New bridged-tee modulator.** Temperature stabilized and compensated network provides carrier suppression *in excess of* 50-db. Patented diode application develops

sideband energy from audio voltage. World's most stable modulator.

These and many other features make your decision *clear*—compare the HT-32 with any other transmitter available. Your supplier has all the details. Stop by and see him today.

ADDITIONAL FACTS ABOUT THE HT-32

- SSB, AM or CW output on 80, 40, 20, 15, 11-10 meter bands.
- High-stability, gear-driven V.F.O.
- 144 watts peak power input.
- Distortion products down 30 db or more.
- Complete band switching.
- C.T.O. direct reading in kilocycles.
- T.V.I. suppressed.

NEW
FROM
hallicrafters
CHICAGO 24, ILLINOIS

*WHERE THE BEST IDEAS IN
COMMUNICATIONS ARE BORN*

EXPORT SALES: Phillips Export Company
100 East 42nd St., New York 17, N. Y.
RADIO & TELEVISION NEWS

WHEN ONLY
THE BEST IS
GOOD ENOUGH...

SOUNDCRAFT "Mylar" * BASE

RECORDING TAPES WITH EXCLUSIVE
PLASTICIZER-FREE OXIDE COATING



Stradivarius
courtesy R. Wurlitzer Collection
PLUS 50 by Soundcraft

Soundcraft tape...and Stradivarius!

Both are acclaimed for lasting perfection. On a Stradivarius, the artist re-creates immortal music. On Soundcraft "Mylar" base tapes, this music is preserved forever. Like the "Mylar" base... Soundcraft's exclusive oxide is *plasticizer-free*—won't age. For enduring—true high fidelity recordings, use these Soundcraft tapes with exclusive Oscar-winning Soundcraft oxide on "Mylar" base.

PLUS 50—get 50% longer play

PLUS 100—twice as much on a reel

"LIFETIME"—guaranteed for life



DuPont trademark

FOR EVERY SOUND REASON

REEVES SOUNDCRAFT CORP.

10 East 52nd Street, New York 22, N. Y.

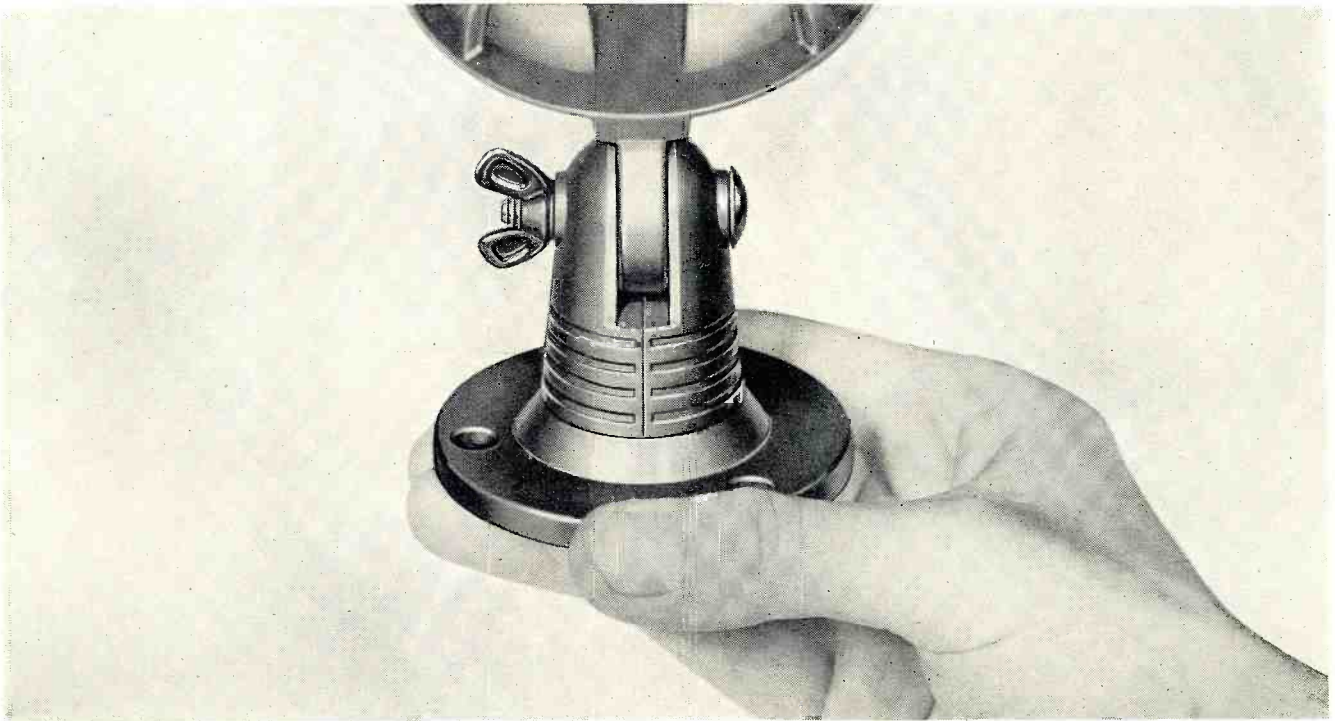

WHAT HAS THIS SPEAKER SWIVEL MOUNT TO DO WITH . . .

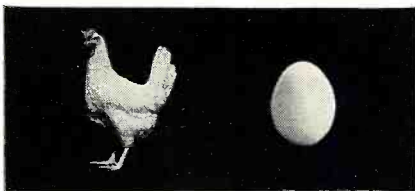

Another great University first

As we've been saying . . . University "firsts" are worth having, worth working toward, worth waiting for. Not the first "Universal" joint to be incorporated into a bracket design, the new University omni-swivel bracket is the first that really works. It is also the only bracket that can fit directly on 1/2 inch pipe. Its *positive-lock* design, precision die-cast construction and versatility of application set new standards by which others will be judged.

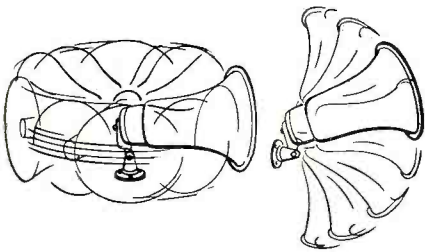

The University Positive-Lock OMNI-SWIVEL base is standard equipment on the Models 1B and MIL series paging and talk-back speakers, and Models CMIL and CIB series wide-angle paging speakers. Additional models will be so equipped in the near future.



Progress that makes waste

As we've been saying . . . *being* the first is not as important to University as being first with a new design of *proven* quality . . . even if it means discarding achievements that no longer meet *our own* high standards. The serrated, die-cast swivel bracket being replaced by the new omni-swivel, is still superior to any other on the market today . . . yet we willingly discard it for the sake of true progress, the most important commodity University has to offer.

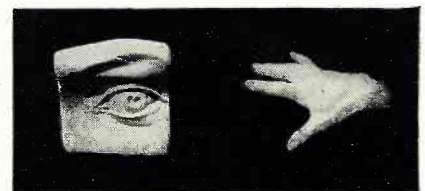
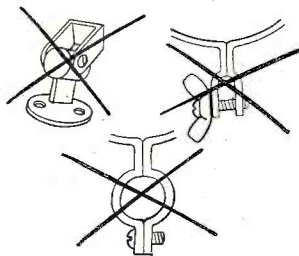

Engineering that makes the difference

As we've been saying . . . the integrity and quality of good engineering is often where you can't see it, or touch it. Yet, these are what make the *difference* in brands . . . differences that spell success or failure of operation, really great value or a poor purchase. The drawing of the new University omni-swivel bracket unveils the ingenuity, meticulous detail and far-sighted design that are the ingredients of *every* University product.

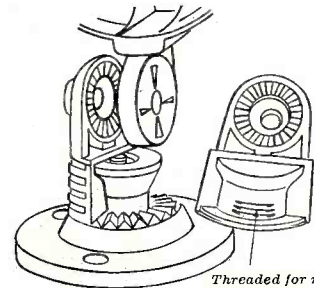

Threaded for mounting directly to 1/2" pipe

UNIVERSITY LOUDSPEAKERS, INC., 80 SOUTH KENSICO AVENUE, WHITE PLAINS, N. Y.

LISTEN

University sounds better



RCA offers you the
 finest training
 at home in
Radio-TV
 electronics,
 TV servicing,
 Color TV

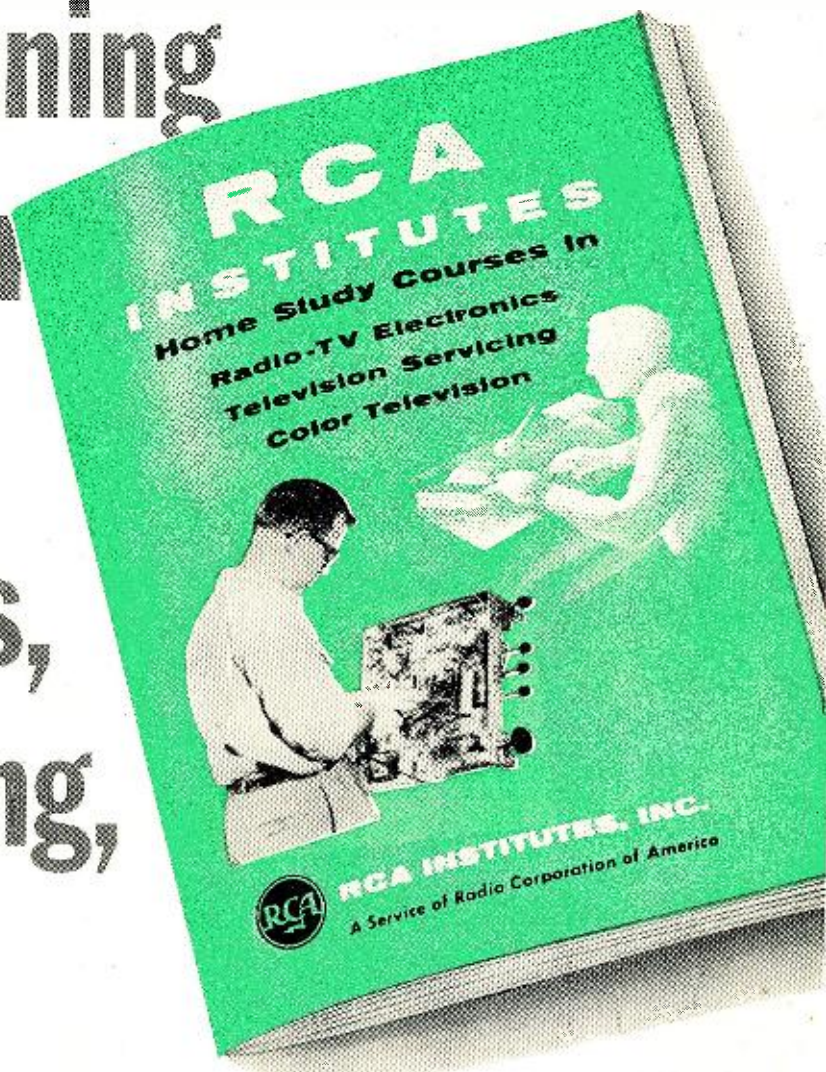

**SEND FOR THIS FREE
 BOOK NOW!**

The instruction you receive and equipment you get (and keep) will start you on your way. Pay-as-you-learn. You pay for only one study group at a time. This 52 page book contains complete information on Home Study Courses for the beginner and the advanced student.



RCA INSTITUTES, INC.
 A SERVICE OF RADIO CORPORATION OF AMERICA
 350 WEST FOURTH STREET, NEW YORK 14, N.Y.

In Canada—RCA Victor Company, Ltd.,
 5001 Cote de Liesse Rd., Montreal 9, Que.

RCA Institutes, Inc., Home Study N-37,
 350 West Fourth Street New York 14, N. Y.
 Without obligation, send me FREE CATALOG
 on Home Study Courses in Radio, Television
 and Color TV. No salesman will call.

Name

Please Print

Address.....

City..... Zone..... State.....

VETERANS

KOREAN G.I.

P.L. 550

CHECK HERE

()

SHOW ANY PICTURE or PATTERN

at any time — ON ANY TV SET

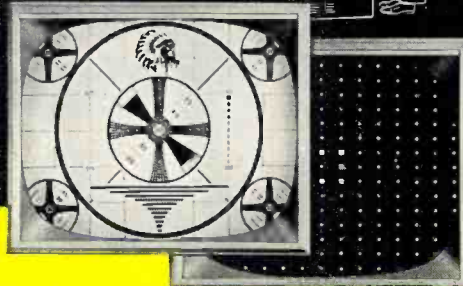
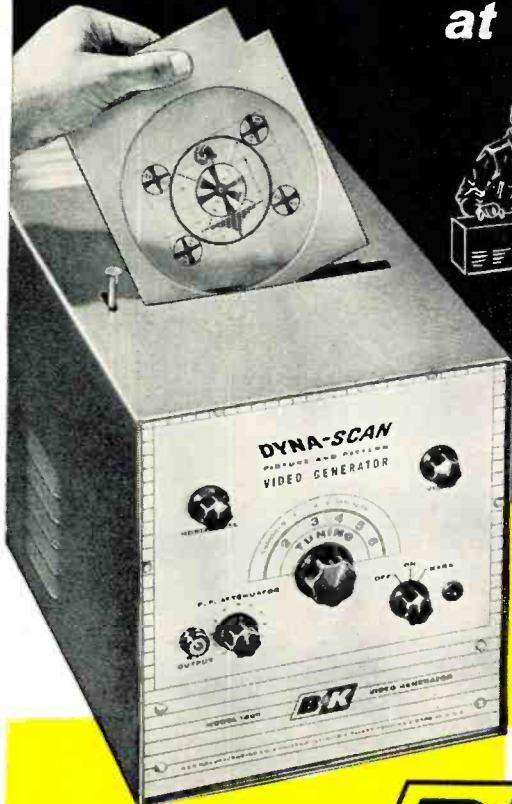

For Both Black & White and Color TV

Provides standard Indian Head Test Pattern for proper TV set alignment, and stable White Dot and White Line Patterns for color convergence adjustments.

For Merchandising & Industrial Uses

Provides closed circuit TV system. Transmits pictures or messages for advertising, educational and commercial visual communication.

MODEL 1000

B&K DYNA-SCAN PICTURE AND PATTERN VIDEO GENERATOR

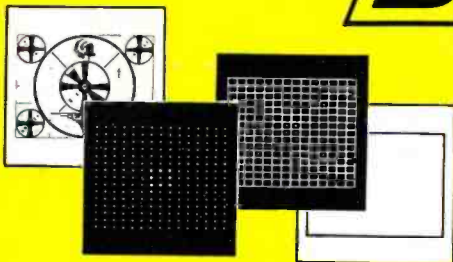

3 TEST PATTERN TRANSPARENCIES AND ONE CLEAR ACETATE SUPPLIED

- 1 Indian Head Test Pattern
- 2 White Dot Pattern
- 3 White Line Crosshatch Pattern

These are broadcast-quality transparencies, and assure accurate, high-definition TV images. You can also transmit your own transparencies of any subject you wish. The clear acetate can be used for special messages. Extra transparencies and acetate available.

Make the most of this *Complete Flying Spot Scanner*. It produces a composite video and sync signal that operates any standard black & white or color TV receiver. Can be used with one or more TV sets or fed into a master antenna system or community antenna system. Maximum resolution capability is well in excess of 450 lines; band width in excess of 5 mc. Projects and reproduces pattern or picture with high definition from any slide transparency. Transmits messages typed or written on clear acetate. Makes convenient stand-by and break in for community distribution operation. Rugged, compact, portable, and ready to operate. **NET \$199⁹⁵**

See your B&K Distributor, or Write for Bulletin No. 1000-N

B & K MANUFACTURING CO.

3726 N. SOUTHPORT AVENUE · CHICAGO 13, ILL.



Model 950 Dyna-Scan Pickup and RF Generator only. Enables you to make your own picture and pattern video generator, at a saving. Supplied with three test pattern transparencies and one clear acetate. Net, \$69.95



Model 500 DYNA-QUIK
Dynamic mutual conductance tube tester. Accurately tests tubes faster. Net, \$109.95



Model 400 CRT
Cathode Rejuvenator Tester. Tests and repairs TV picture tubes. Net, \$54.95



Model 750 CALIBRATOR
Designed to check and adjust test instruments with laboratory accuracy. Net, \$54.95

6 months
from today

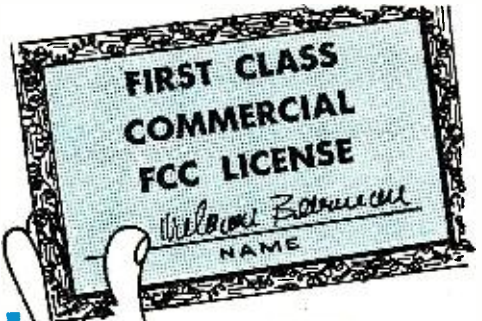
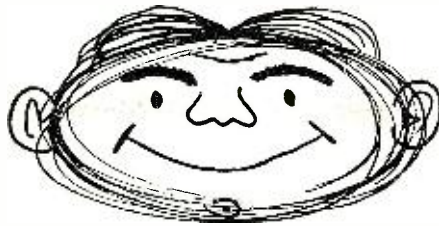

WHICH WILL YOU HOLD ...

OR



add technical training to your practical experience. **GET YOUR FCC LICENSE QUICKLY!**

then use our effective **JOB FINDING SERVICE!**

WE GUARANTEE

YOUR FCC LICENSE

If you fail to pass your Commercial License exam after completing our course, we guarantee to continue your training without additional cost of any kind until you successfully obtain your Commercial License.

HERE'S PROOF FCC LICENSES CAN BE SECURED IN A FEW HOURS OF STUDY With OUR Training AT HOME In Spare Time.

Name and Address	License	Time
Walter Eggers, Pacific Grove, Calif.....	1st	12 weeks
Paul Reichert, West Salem, Ohio.....	2nd	10 weeks
Harold Phipps, LaPorte, Indiana.....	1st	28 weeks
John H. Johnson, Boise City, Okla.....	2nd	12 weeks
James Faint, Johnstown, Pa.....	1st	26 weeks

Employers Make OFFERS Like These

to Our Graduates Every Month

Broadcast Station in Illinois: "We are in need of an engineer with a first class phone license, preferably a student of Cleveland Institute of Radio Electronics; 40 hour week plus 8 hours overtime."

West Coast Manufacturer: "We are currently in need of men with electronics training or experience in radar maintenance. We would appreciate your referral of interested persons to us."

Our Trainees Get Jobs Like These Every Month



CHIEF ENGINEER

"Since enrolling with Cleveland Institute I have received my 1st class license, served as a transmitter engineer and am now Chief Engineer of Station WAIN. I also have a Motorola 2-Way Service Station. Thanks to the Institute for making this possible."

Lewis M. Owens, Columbia, Ky.

TEST ENGINEER

"I am pleased to inform you that I recently secured a position as Test Engineer with Melpar, Inc. (Subsidiary of Westinghouse). A substantial salary increase was involved. My Cleveland Institute training played a major role in qualifying me for this position."

Boyd Daugherty, Falls Church, Va.



NAMES OF TRAINEES IN YOUR AREA PROVIDED ON REQUEST
Carl E. Smith, E.E., President

CLEVELAND INSTITUTE OF RADIO ELECTRONICS
Desk RN-3, 4900 Euclid Bldg., Cleveland 3, Ohio

Get these valuable **BOOKLETS**

FREE!



Accredited by National Home Study Council

Cleveland Institute of Radio Electronics

Dept. RN-3, 4900 Euclid Bldg., Cleveland 3, O.

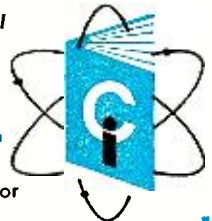

Please send Free Booklets prepared to help me get ahead in Electronics. I have had training or experience in Electronics as indicated below:

- | | |
|---|---|
| <input type="checkbox"/> Military | <input type="checkbox"/> Broadcasting |
| <input type="checkbox"/> Radio-TV Servicing | <input type="checkbox"/> Home Experimenting |
| <input type="checkbox"/> Manufacturing | <input type="checkbox"/> Telephone Company |
| <input type="checkbox"/> Amateur Radio | <input type="checkbox"/> Other _____ |

In what kind of work are you now engaged? _____

In what branch of Electronics are you interested? _____

Name _____ Age _____

Address _____

City _____ Zone _____ State _____

Special Tuition Rates to Members of Armed Forces

**You can have
the finest sound
reproduction
throughout all
frequency ranges
without distortion**

You will hear a remarkable difference in the clarity of Norelco *Full Response Speakers. In a single speaker, twin-cones reproduce low frequencies, middle range, as well as the higher frequencies extending beyond the audible range—without distortion.

Norelco F.R.S.

speakers are available
5", 8" or 12" sizes in
standard impedances.
Priced from \$6.75 to \$59.98
Blue prints are available
for the do-it-yourself
enclosure builder.



**WHY ARE NORELCO
FRS SPEAKERS
SO EXCEPTIONAL?**

They have incorporated a number of technical refinements which are evident the moment you listen. The air gap has been made long so that the coil is completely enclosed in an even magnetic field at all times. A copper ring has been fitted into the deep air gap to keep the voice coil impedance constant over the whole frequency range; this avoids incorrect matching. High flux densities are obtained through the use of "Ticonal" magnet steel.

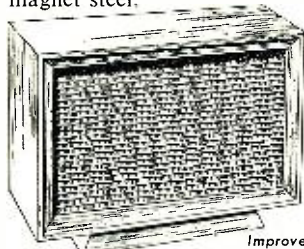

Norelco FRS
Improved Bass Reflex
Enclosures are available in
three sizes; FRS Enclosures I, II and III.
Priced from \$33.75 to \$119.95.

Norelco speaker-matched enclosures are scientifically designed acoustical boxes which enhance the exceptional tone qualities of FRS speakers; bringing out their true performance values.

Norelco FRS Speaker Enclosures are available in three sizes to match the characteristics of the speaker in use. Supplied in either mahogany or blond, these enclosures incorporate a removable base permitting the enclosures to be placed horizontally or vertically to suit any room arrangement or decor.

**ADD TO...and improve any sound
system with Norelco®**

*FULL RESPONSE SPEAKERS

Write today to Dept. G3 for brochures
and prices of these unique speakers.

NORTH AMERICAN PHILIPS CO., INC.
100 E. 42nd St., New York 17, N.Y.



Spot Radio News

★ Presenting latest information on the Radio Industry.

By RADIO & TELEVISION NEWS'
WASHINGTON EDITOR

THIS STRIKING ELECTRONIC ERA received a historic progress report in FCC's annual review prepared for Congress.

Detailing the advancements of the past years, the Commission said that giant strides were made in every phase of electronics: Ten years ago, radio authorizations of all kinds (stations and operators) totaled less than 550,000. Today that figure has been more than doubled to over 1,600,000. In 1946, there were forty different classes of radio services. Now, the Commission disclosed, the number is around sixty-five. In '46, broadcast grants were less than 2500; today authorizations have multiplied to over 7000.

Commenting on the increases in the non-broadcast field, the FCC said that authorizations in the aviation, marine, land transportation, public safety, industrial, amateur, and other services have, during the past ten years, moved up from less than 92,000 to nearly 340,000, a gain of nearly 400 per-cent. And within that same period, the number of commercial operator authorizations to man these stations has multiplied more than threefold; from

about 315,000 to well over 1.1 million.

In 1946, the Commission noted, radiotelephone service was being tested in isolated communities. It was also the year when the first common carrier urban mobile-radiotelephone service went into operation; when railroads and public utilities began radio communication on a regular basis; when radio was being explored as a means of directing the movement of taxicabs, trucks, and buses; when ship radar was a novelty; when the number of homes having broadcast sets was less than 60,000,000 and when there were only 30 commercial TV station authorizations.

The next year saw a number of improvements, the Commission continued: Radio became available for power, transit, and petroleum pipeline operations; radar became a regular marine service and the first microwave links were introduced.

The year 1948 witnessed the beginning of public radiotelephone service to and from moving trains and the announcement that the transistor had been developed. In the following year, Congress was told, industrial, land

NEW TV GRANTS SINCE FREEZE LIFT

Continuing the listing of construction permits granted by FCC since lifting of freeze. Additional stations will be carried next month.

STATE	CITY	CALL	CHANNEL	FREQUENCY	POWER*
Alabama	Birmingham	42	638-644	16.6
California	San Francisco	26	542-548	257
North Carolina	Charlotte	WSUC-TV	9	186-192	316
South Dakota	Reliance	6	82-88	53.7
" "	Rapid City	KRSD-TV	7	174-180	534
Utah	Salt Lake City	7	174-180	22.9

NEW CALL LETTER ASSIGNMENTS

STATE	CITY	CALL	CHANNEL	FREQUENCY
Kentucky	Paducah	WPSD	6	82-88
Maine	Augusta	WPPT	10	192-198
Missouri	Joplin	KODE-TV (Formerly KSWM-TV)	12	204-210
Texas	Bryan	KBTX-TV (Formerly KGTX-TV)	3	60-66
Washington	Walla Walla	KWAB	8	180-186
Wyoming	Casper	KTWO-TV	2	54-60

*ERP = (effective radiated power, kw.)

**GREATEST
ADVANCE IN
SHOP-METHOD
HOME TRAINING**

EARN MORE MONEY...GET INTO TELEVISION ELECTRONICS-RADIO

Learn ALL 8 PHASES in ONE MODERN HOME-STUDY COURSE
At Home - In Spare Time

YOU GET ALL THIS NEWEST PRACTICAL EQUIPMENT

- Parts to build a modern TV set, including all tubes plus a large screen Picture Tube
- Parts to build a powerful Superhet Receiver, standard broadcast and short wave
- Parts to conduct many experiments and build Continuity Checker, RF Oscillator, TV Circuits, Audio Oscillator, TRF Receiver, Signal Generator
- A Valuable Professional Multitester



**19 BIG KITS
YOURS TO KEEP.**

YOUR NATIONAL SCHOOLS TELERAMA COURSE COVERS ALL 8 PHASES

- | | |
|------------------------------------|--------------------------------|
| 1. TELEVISION, INCLUDING COLOR TV | 5. PREPARATION FOR FCC LICENSE |
| 2. RADIO, FM AND AM | 6. AUTOMATION |
| 3. INDUSTRIAL ELECTRONICS | 7. RADAR AND MICRO WAVES |
| 4. SOUND RECORDING AND HI FIDELITY | 8. COMMUNICATIONS |

YOU ARE NEEDED IN THE TELEVISION-ELECTRONICS-RADIO INDUSTRY!

You can build a secure future for yourself if you get into Electronics NOW! Today's shortage of trained technicians creates tremendous opportunities. National Schools Shop-Method trained technicians are in constant and growing demand for high-pay jobs in Broadcasting and Communications, Electronic Research, Servicing and Repair, and many other branches.

— many other materials and services
— consultation privilege with our qualified staff, and Graduate Employment Service. EVERYTHING YOU NEED for outstanding success in Electronics.

Let National Schools, a Resident Technical School for over 50 years train you for today's unlimited opportunities in electronics! Our Shop Method trains you to be a MASTER-TECHNICIAN. Completely up to date, developed by experienced instructors and engineers, your Telerama Course will teach you all phases of the industry quickly, clearly and correctly. You can master the most modern projects, such as Color TV, printed circuits — even prepare for FCC License without taking a special

course. You can handle sales, servicing, manufacturing, or make good money in your own business. SEND FOR FACTS TODAY!

EARN AS YOU LEARN. Many of our students earn their entire tuition and more in Spare Time jobs we show them how to do while learning.

YOU GET EVERYTHING YOU NEED — Clear, profusely illustrated lessons, shop-tested manuals, modern circuit diagrams, practical job projects — all the valuable equipment shown above

RESIDENT TRAINING AT LOS ANGELES

If you wish to take your training in our Resident School at Los Angeles, the world's TV capital, start NOW in our big, modern Shops, Labs and Radio-TV Studios. Here you work with latest Electronic equipment—professionally installed—finest, most complete facilities offered by any school. Expert, friendly instructors. Personal attention. Graduate Employment Service. Help in finding home near school—and part time job while you learn. Check box in coupon for full information.



FREE! Fully illustrated "Career" Book in TV-Radio-Electronics. PLUS actual sample lesson—yours at no cost, no obligation. CLIP COUPON NOW... MAIL IT TODAY!

APPROVED FOR G.I. TRAINING

NATIONAL SCHOOLS

4000 S. FIGUEROA ST., LOS ANGELES 37, CALIF.
187 N. LA SALLE ST., CHICAGO 1, ILL.
IN CANADA: 811 W. HASTINGS ST., VANCOUVER, B. C.

NATIONAL SCHOOLS

TECHNICAL TRADE TRAINING SINCE 1905
LOS ANGELES 37, CALIFORNIA

GET FAST SERVICE—MAIL NOW TO OFFICE NEAREST YOU!

NATIONAL SCHOOLS, DEPT. RH-37
4000 S. FIGUEROA ST. LOS ANGELES 37, CALIF. OR 187 N. LA SALLE ST. CHICAGO 1, ILL.
Rush free TV-Radio "Opportunity" Book and sample lesson. No salesman will call.

NAME _____ AGE _____
ADDRESS _____
CITY _____ ZONE _____ STATE _____

Check if interested ONLY in Resident School training at Los Angeles.
VETERANS: Give date of Discharge _____

All new ultra-compact amplifier

SONOTONE HFA-150

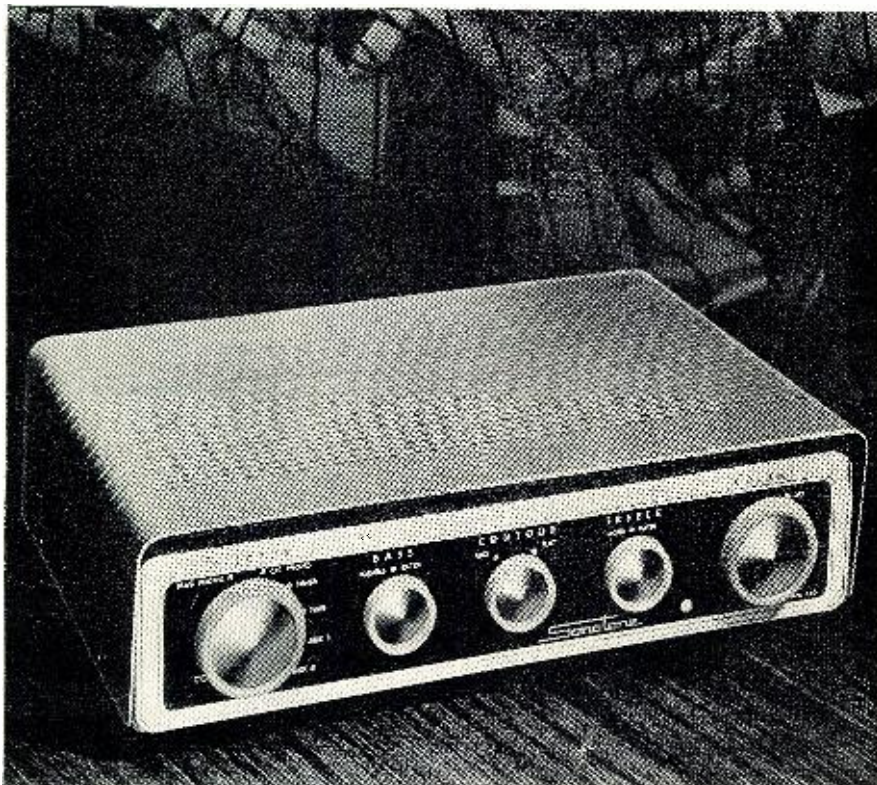

15-WATT POWER AT A 10-WATT PRICE!

No amplifier on the market today can compare with the all-new Sonotone HFA-150. Full 15-watt power—superb sound—plus more new, useful “firsts” than any other amplifier at any price.

ONLY 3" HIGH—12" WIDE! For the first time, a complete power and control amplifier this compact...without an iota of performance being sacrificed to compactness. The ultra-smart cabinet cover is available in a choice of colors—another Sonotone first!

SIX INPUTS! For the first time, a quality amplifier in this price range that gives you single switch choice

of 6 inputs. Three of these inputs have *individual pre-set level controls!*

SEPARATE CONTOUR CONTROL! For the first time you get new, exclusive push-pull rumble and noise filters. Bass, treble and volume controls with a *separate* continuous contour control, infinitely variable from flat to 26 db of contour compensation.

The Sonotone HFA-150 is, unquestionably, the greatest value in *fine* high fidelity components in many years. Make seeing and hearing it a “must”!

ONLY \$79⁵⁰ NET

Optional cover \$3.50 Net

Write for detailed information without obligation to:

Electronic Applications Division

SONOTONE[®] CORPORATION

ELMSFORD, N. Y.



transportation, and citizens radio services were established; the eastern and midwestern coaxial cable systems were joined; and the first harbor-shore radar installation was made.

In 1950 the first color-TV system was approved and initial toll-TV tests were approved. And in '51, the Commission said, TV came of age with the inauguration of the coast-to-coast microwave and coax cable system. It was the year, too, that disaster communications and industrial radio-location services were authorized and a novice class of amateur radio-operator license was provided for the beginner.

In 1952, as a result of four years of hearings, the Commission opened u.h.f. to TV broadcasting and v.h.f. and u.h.f. channels were assigned to communities throughout the country. Also in that year, the FCC report added, radio amateur civil-emergency service became operative; international agreement was reached to bring into world force revised allocations of spectrum space to the various radio services; territories received their first FM and TV broadcast grants; and local communities began organizing to cope with TV's growing interference problems.

The year 1953 was a memorable one, the FCC records show. For in that year new color-TV standards were adopted, substituting a compatible system for the incompatible system of 1950.

The twentieth anniversary of the FCC (1954) saw radio's uses extending from the cradle to the grave—from expediting medical aid to expectant mothers to directing funeral processions. It was also the year when the first grants were made to private microwave systems for relaying TV programs. In 1955, the Commission said, it was found practical to employ over-the-horizon transmission and, accordingly, official tests were authorized.

Today, the Congress was told, business is showing an unprecedented interest in utilizing radio and TV as a modern messenger to serve a variety of its needs; as a result, unparalleled expansion surely lies ahead.

BECAUSE OF THE GROWTH of the nation's communications services, the report added, the Commission was faced by many allocation problems.

Commenting on these difficulties in a year-end statement, the FCC's chairman said that the mushrooming of transmitters, coupled with the mounting popularity of electronic gadgets, is causing an enormous amount of interference which is difficult to control. And in broadcasting, the Commissioner continued, the AM band is so congested that only small local daytime-only stations seem able to shoe-horn in.

Noting that as much as the Commission would like to resolve all of the problems which face them with speed, present rigid procedures pre-

(Continued on page 112)

Your independent service business can grow

Advertisements like this are appearing every month in all local editions of TV Guide to help you.

Ask your CBS Tube distributor how you can have *your* name, address and telephone number listed on the facing page in your local edition.

Join with other *independent* service-dealers . . . *independent* parts distributors . . . and CBS Tubes. Working together, we can build a strong *independent* service industry.

CBS is taking the lead for you . . . and in an important way. Month after month this advertising campaign is reaching millions of TV homes. And it is telling them why they should always call their neighborhood independent service-dealer whenever their radio or television sets need service.

Remember: Your continuous purchases of CBS tubes make this *independent* service-dealer campaign possible. So help keep it going. Say, "I want CBS tubes!"



CBS-HYTRON Danvers, Massachusetts

A Division of
Columbia Broadcasting System, Inc.

March, 1957



PICTURE TUBES DO GET DIRTY! SO CALL YOUR INDEPENDENT SERVICE-DEALER AND . . .

Have your
Picture Tube
cleaned today! ..

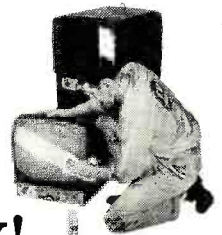

Just like windows and mirrors, the inside of the glass front on your TV set gets dirty. And the face of your picture tube — the TV screen — gets even more fogged up with dust and dirt, smoke and fumes. See for yourself. Have your picture tube cleaned today. You can't imagine how much clearer . . . brighter . . . and more enjoyable your TV picture will be!

CALL YOUR INDEPENDENT SERVICE-DEALER FOR HIS SPECIAL "PICTURE TUBE CLEAN-UP."

He is *your* neighbor. He pays taxes in *your* community. His children go to the same schools and churches as *yours*. And he knows his standing and reputation depend upon the care and thoroughness with which he services your community's radio and television sets. What is more, he is trained to service any make of set. So patronize your neighborhood independent radio and television service-dealer.

© CBS-HYTRON, Danvers, Mass.
A Division of Columbia Broadcasting System, Inc.



Ask him for CBS tubes. There are no better tubes made . . . and CBS tubes have this seal.



This emblem is one way to identify your independent radio and television service-dealer. Look for it.

Tie-in: Ask your distributor for free window display, P-130. And for free, 4-page PA-131 folder giving complete details about your Independent Service campaign . . . and about other specially imprinted tie-in material.

why the Collaro

RC-456

is today's outstanding HIGH FIDELITY RECORD CHANGER



**Minimum
Noise and
Distortion**

Balanced, heavy 4-pole motor . . .
balanced pulley and coupler reduce
rumble to an inaudible minimum.
Automatic muting switch and R/C
network eliminate 'clicks.'

**Accurate
Speed & Pitch**

Collaro quality control limits for the
RC-456 are .25% wow and flutter
. . . unmatched by any other
record changer.

Jam-Proof

Collaro safety-clutch prevents
damage even if tone-arm is held
or moved during change cycle.

Four Speeds

Plays all 78, 45 and 33 $\frac{1}{3}$ rpm
records . . . plus new types designed
for 16 $\frac{2}{3}$ rpm speed.

**Automatic
Intermix**

Plays 7, 10 and 12-inch records
stacked in any order —
automatically.

**Manual
Operation**

For playing records individually or
for selecting and playing specific
bands and parts of a record.

**Simple
Installation**

Prewired power and audio connections
eliminate soldering. Pre-cut
mounting board available.

...Plus

- ★ Rapid change cycle independent of record speed.
- ★ Automatic 'shut-off' after last record.
- ★ Simple, one-knob speed selection.
- ★ Gentle, straight-spindle record handling.
- ★ Interchangeable, plug-in cartridge shells.
- ★ Heavy, rim-weighted turntable for flywheel action.
- ★ Automatic idler-disengage prevents idler flats.



At leading sound dealers, or write Dept. XC-4

ROCKBAR CORPORATION • 650 Halstead Avenue, Mamaroneck, N. Y.



RADIO & TELEVISION NEWS

IT'S NEW! Send for this

FREE

booklet today!

see

what the

rapidly

expanding

field of

ELECTRONICS

offers

you

- BETTER JOB
- BETTER PAY
- PROMOTION
- GREATER SECURITY
- GREATER CONFIDENCE
- BETTER LIVING FOR YOU AND YOUR FAMILY

All these benefits can be yours if you act now! Take that first big step this minute —No obligation whatsoever!

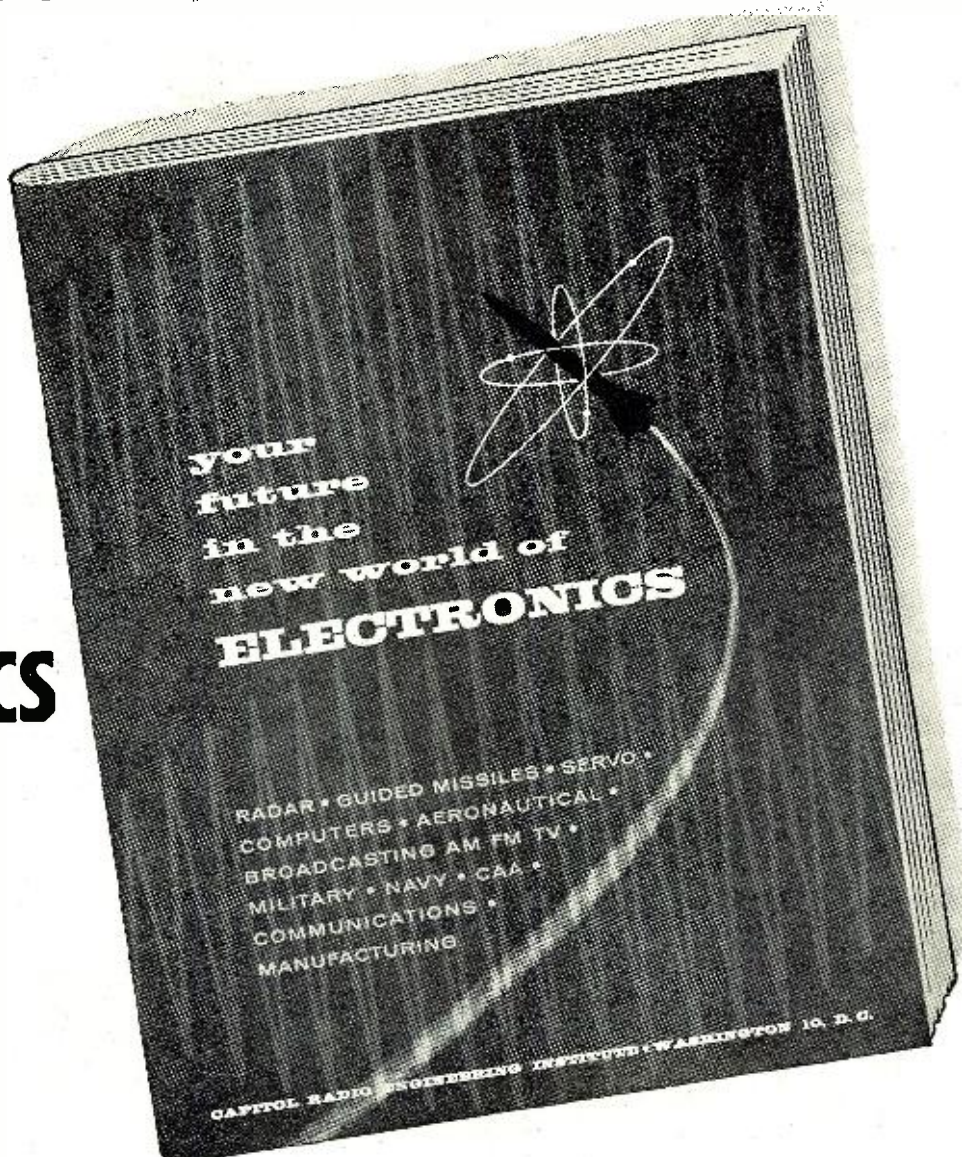

TAKE A MINUTE TO MAIL THIS COUPON FOR FREE BOOKLET !

CAPITOL RADIO ENGINEERING INSTITUTE

Accredited Technical Institute Curricula Founded 1927
 Dept. 113-D, 3224—16th St., N. W., Washington 10, D. C.

Please send me your course outline and FREE illustrated Booklet "Your Future in the New World of Electronics" . . . describing opportunities and CREI home study course in Practical Electronics Engineering.

- | | | | |
|----------|---|---|----------|
| CHECK | } | <input type="checkbox"/> Practical Radio Electronics Engineering | |
| FIELD OF | | <input type="checkbox"/> Broadcast Radio Engineering (AM, FM, TV) | |
| GREATEST | | <input type="checkbox"/> Practical Television Engineering | |
| INTEREST | | <input type="checkbox"/> Aeronautical Electronics Engineering | H |

Name Age

Street

City.....Zone..... State.....

CHECK: Home Study Residence School Korean Veteran

To help us answer your request intelligently, please give the following information:

EMPLOYED BY.....

TYPE OF PRESENT WORK.....

SCHOOL BACKGROUND.....

ELECTRONICS EXPERIENCE.....

IN WHAT BRANCH OF ELECTRONICS ARE YOU MOST INTERESTED?

.....

.....

.....

MODEL 280SW (shown right)

- Double stacked array PLUS high frequency elements.
- All Aluminum Construction.
- Mounts on any mast up to 1 1/4".
- QUICK-RIG design for speedy one man installation.
- Complete with stacking bars.

MODEL 180SW . . . same as 280SW only not double stacked.

MODEL 180 . . . QUICK-RIG 8 element "Lazy-X" Conical.

MODEL 280 . . . QUICK-RIG double stacked "Lazy-X" Conical.

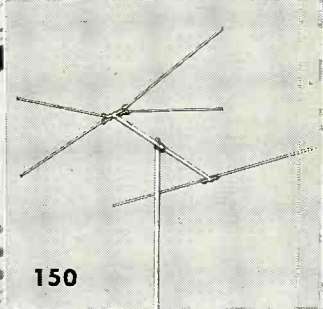
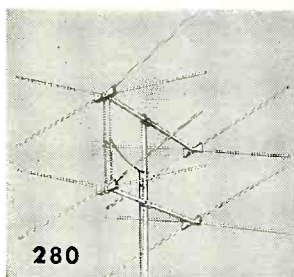
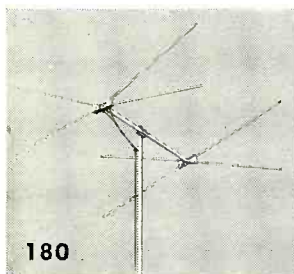

TV ANTENNAS

**Proven Unquestionably . . .
the best performing at
the lowest possible price!**

RADIART . . . the name you can depend upon for **QUALITY** and **VALUE** . . . offers a **COMPLETE** . . . and **NEWLY ENGINEERED** line of superbly performing TV antennas at an economy price. Carefully tested under all conditions . . . each of these new models is guaranteed to be the **best performing** at the lowest possible price.

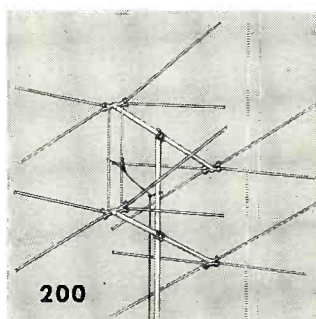
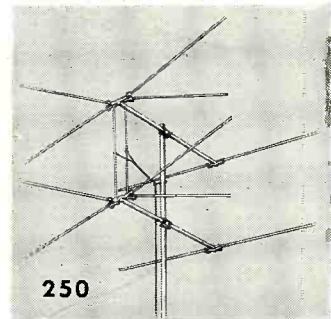
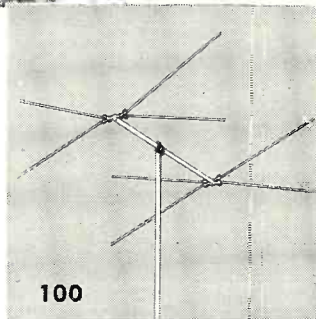

- LZX 100** single array
- LZX 101** single array, unassembled
- LZX 200** 8 element conical completely assembled, stacked array
- LZX 201** 8 element conical unassembled, stacked array
- LZX 150** single array
- LZX 151** single array, unassembled
- LZX 250** 6 element conical assembled, stacked array
- LZX 251** 6 element conical unassembled, stacked array



THE RADIART CORPORATION / CLEVELAND 13, OHIO

The Keynote of the 3rd Annual
NATIONAL TELEVISION SERVICEMEN'S WEEK^{*}
is **YOU!**



Once again, RCA salutes its partners in the great electronic industry—*you*, the TV servicemen—whose neighborhood is America, whose business is America's entertainment! This year, RCA's salute to you is carried over network radio and TV, including March 16th TV Emmy Awards program and March 23rd Perry Como show; in the March 25th issue of Life, and the March 23rd issues of the Saturday Evening Post and TV Guide; in local newspapers; via displays, streamers and mailings, in every town and city from coast to coast. All America joins with us in a tribute to you—the men who help keep the nation's TV "rollin'!"

*REGISTERED WITH U. S. CHAMBER OF COMMERCE, MARCH 25 TO 30

EXTRA! EXTRA! To Dealers Who Can Qualify here is the most powerful identification program that RCA has ever offered:

be an **AUTHORIZED RCA ELECTRON TUBE DEALER**
for Prestige... for Profit

See your RCA Distributor salesman today, and get all the facts.



RADIO CORPORATION of AMERICA
Tube Division Harrison, New Jersey



Is a Degree Essential for an Electronic Engineering Career?



"Student" Fred Gunther in the IBM school

Fred Gunther has no degree. Yet, today, at IBM, Fred is a Computer Systems Engineer on America's biggest electronics project. His story is significant to every technician who feels that lack of formal training is blocking his road to the top.

Let's go back to 1950 and watch Fred Gunther, at 18, as he goes about the business of determining his life's work. Fred spent almost a year interviewing with prospective employers. Then, perhaps due to the fact that his high school background didn't prepare him for work in an area of his interest, he entered the Navy for a four-year hitch.

Fred learned something very valuable in the Service, as have many other men who eventually discover the electronics field. His aptitude tests revealed him as an excellent electronics prospect, and he received ten months' training in electronics fundamentals and radar. Upon his discharge in 1955, he was an Electronics Technician, First Class.

Something even more important to Fred's career occurred during his Service hitch. He began to hear such terms as "automation" . . . "data processing" . . . "electronic computer." "Then, one evening, while glancing through the paper," he recalls, "I spotted a story about *Project SAGE*."

What is Project SAGE?

SAGE means Semi-Automatic Ground Environment. It is America's giant radar system—a chain of defense that will ultimately ring our country's entire perimeter. Heart of this system is the electronic computers, which digest data filtered in from Texas towers, picket ships, reconnaissance planes, ground observers. The computers analyze this information for action by the Strategic Air Command and other defense units. These computers are the largest in the world. Each contains perhaps a million parts—occupies an entire city block. They are built for the Project by IBM.



Answering instructor's questions

Fred joins IBM

SAGE fascinated Fred, for it embodies the most advanced electronic concepts. And, when he learned that IBM would train him for six months, at full salary, plus a living allowance, to become a *Computer Units Field Engineer*, he seized the opportunity. Fred started his new electronics career in the IBM school, with twenty other technicians. He attended classes 8 hours a day. Courses consisted of some 20 subjects—computer circuitry and units, maintenance techniques—everything he would need to become a full-fledged *Computer Units Field Engineer*.

Assigned to McGuire AFB

His six months' training completed, Fred was assigned in May, 1956, to McGuire Field, where the first of the giant SAGE computers is located. Here he supervised the cable installation for this vastly complicated electronic giant. He helped to set up the computer, interconnect its many sections, check it out and make it ready for operation. Fred spent five months

at McGuire, but his education was not yet completed.

Becoming a Computer Systems Engineer

"I like to think it was due to my interest and grade of work," Fred says, "but at any rate, last November I was invited to return to Kingston for further training—to become, in fact, a *Computer Systems Engineer*. Naturally, I was proud and pleased, for this training would give me a much greater range of understanding . . . make me more valuable to the company and myself . . . and give me a chance to assume actual engineering responsibility." Fred is once more



at the operating console of the computer

putting in a full 8-hour training day—both classroom and lab. By the time you read this message, he will have completed his new education and be ready for assignment as a *Computer Systems Engineer* to an area of his choice.

What does the future hold?

"First off, I'll probably go back to McGuire," Fred says. "My home is nearby and there's still a vast amount of work to be done at this computer site. The future? It's hard to even set a goal in a field as rapidly moving as this, but with my IBM training back of me, the future sure looks good. I've advanced from radar technician to *Computer Systems Engineer* in sixteen months—and received a valuable electronics education besides!"

How about YOU?

Since Fred Gunther joined IBM Military Products and the Project SAGE program, opportunities are more promising than ever. This long-range program is destined for increasing national importance, and IBM

will invest thousands of dollars in the right men to insure its success.

If you have 2 years' technical schooling—or equivalent experience—IBM will train you for 6 months as a *Computer Units Field Engineer*.

If IBM considers your experience equivalent to an E.E., M.E., or Physics degree, you'll receive 8 months' training as a *Computer Systems Engineer*.

After training, you will be assigned to an area of your choice within the United States. You receive *salary*, not wages, plus overtime pay. In addition, every channel of advancement in the entire company is open,



Home to the family, Pemberton, N. J.

and IBM is a leader in a field that is sky-rocketing in growth. And, of course, you receive the famous IBM company-paid benefits that set standards for industry.

WHY NOT WRITE—today—to Nelson O. Heyer, Room 4303, IBM Corp., Kingston, N. Y.? You'll receive a prompt reply. Personal interviews arranged in all areas of the United States if your résumé of experience and education indicates you have the qualifications.

CUSTOMER ENGINEERS: Opportunities are also available, locally, for servicing IBM machines, after training with pay.

Be sure to visit the IBM booth at the I.R.E. Show, March 18 through 21.



- DATA PROCESSING
- ELECTRIC TYPEWRITERS
- TIME EQUIPMENT
- MILITARY PRODUCTS

how long would it take you to solve this service problem?

SYMPTOM: Loss of both vertical
and horizontal synchronization.

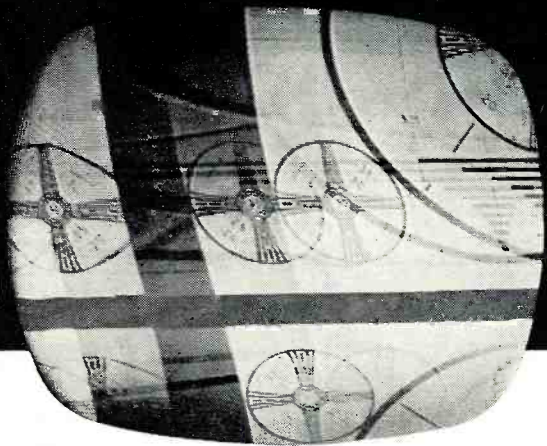

PHOTOFACT helps you lick problems like this in just minutes for only **2½¢** per model!

Let's take a look at this problem: The loss of both vertical and horizontal synchronization is very often a result of defective components in the sync circuits. So look for the following possible causes—

- 1 Defective tube in sync or noise-limiter stages
- 2 Video-coupling capacitor (C51) shorted, leaky, or open
- 3 Plate resistors (R45, R48, R49) open or too high in voltage
- 4 Shorted or leaky coupling capacitor (C53)
- 5 Sync isolation resistor (R33) open or too high in value
- 6 Resistance of voltage divider (R46) changed in value
- 7 Improper cathode bias in R47

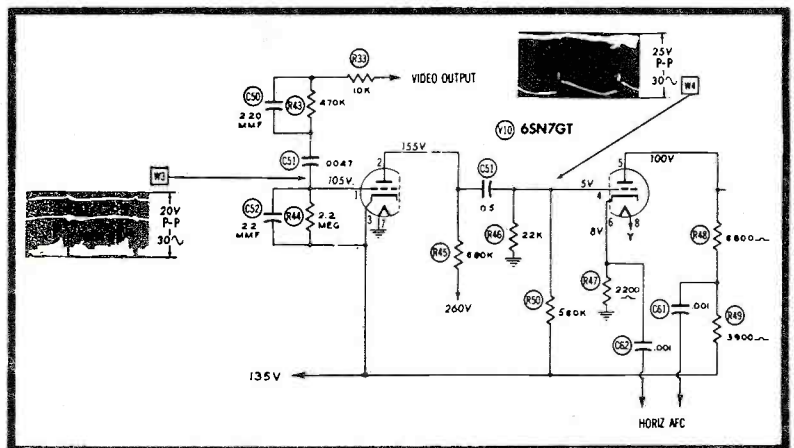

With a PHOTOFACT Folder by your side, you trouble-shoot and solve this problem in just minutes. Here's how: Check the sync tube (V10). You locate the tube in just seconds on the Tube Placement Chart you'll always find in each PHOTOFACT TV Folder. It also shows the locating lug for use in replacement when the sockets are "hidden."

Now, if the tube isn't the culprit in this case, use a scope and check for

proper waveform and amplitude of signal at pin 1 of V10. The correct waveform is shown right on the Standard Notation Schematic featured exclusively in all PHOTOFACT Folders. Waveform incorrect?—check for defective R33 or C51. Waveform okay?—then:

Check waveform at Pin 4 of V10. Something wrong?—check voltages (they're always on the schematic). Resistance check?—use the handy, easy-

to-read resistance chart. In just minutes you can check for defective part R45, R46 or C53. Waveform okay?—then:

Check voltages and/or resistances at pins 5 and 6 of V10 to determine if R47, R48, or R49 is defective. The exclusive PHOTOFACT chassis photos (with call-outs keyed to schematic) help you quickly locate faulty parts. The complete parts list shows ratings and proper replacements...

Use the servicing method you prefer: checking of waveform, voltage or resistance—they're all at your finger-tips in PHOTOFACT. For only 2½¢ per model, PHOTOFACT helps you solve your service problems in just minutes—helps you service more sets and earn more daily!



MONEY BACK GUARANTEE!

Got a tough repair? Try this—at Howard W. Sams' own risk: see your Parts Distributor and buy the proper PHOTOFACT Folder Set covering the receiver. Then use it on the actual repair. If PHOTOFACT doesn't save you time, doesn't make the job easier and more profitable for you, Howard W. Sams wants you to return the complete Folder Set direct to him and he'll refund your purchase price promptly. **GET THE PROOF FOR YOURSELF—TRY PHOTOFACT NOW!**

FREE



FOR SERVICE TECHNICIANS ONLY

Fill out and mail coupon today for Free subscription to the Sams Photofact Index —your up-to-date guide to virtually any receiver model ever to come into your shop. Send coupon now.

HOWARD W. SAMS & CO., INC.

Howard W. Sams & Co., Inc.
2203 E. 46th St. Indianapolis 5, Ind.

Put me on your mailing list to receive the Sams Photofact Index and Supplements. My (letterhead) (business card) is attached.

I'm a Service Technician: full time; part time

My Distributor is: _____

Shop Name _____

Attn: _____

Address: _____

City _____ Zone _____ State _____

THERE IS A DIFFERENCE IN HIGH-FIDELITY SPEAKERS

and you can hear it in the

Electro-Voice®

ARISTOCRAT

Electro-Voice® ARISTOCRAT

FOLDED-HORN CORNER ENCLOSURE

... And what a difference Electro-Voice brings to high fidelity ... you'll tingle to silky smooth highs, thrill to the pulsating impact of the "clear," low bass. Once you've heard it, you'll know why we emphasize that there is a difference in hi-fi, and you can hear it. You'll silently decide that here's the hi-fi for you.

A wise decision it is, indeed. Electro-Voice makes the finest speakers possible, balances them to each other, and then matches them to the ARISTOCRAT Folded-Horn Enclosure. The difference? A whole octave more of bass reproduction, highest efficiency and unique realism are yours!

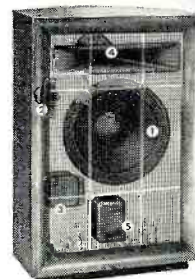
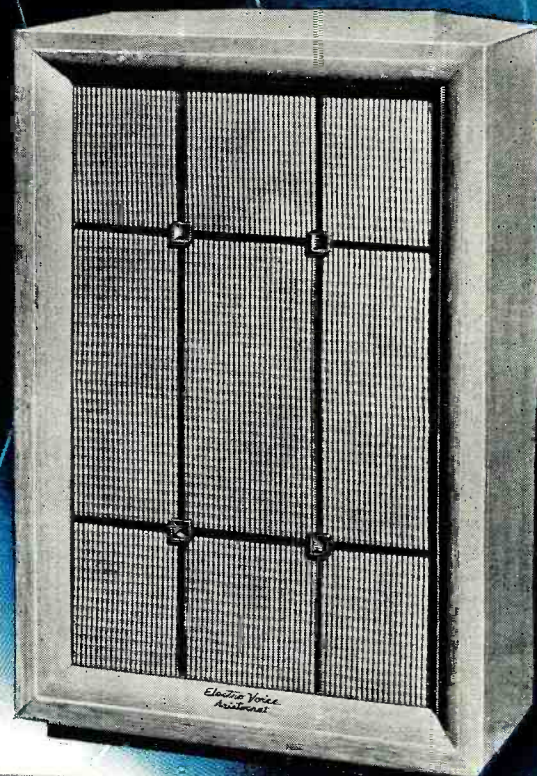

- 1 SP12B
- 2 T35B
- 3 X36
- 4 T10A with 8HD
- 5 X825



- 1 Model SP12B Radax Coaxial Speaker Net \$33.00
ARISTOCRAT Enclosure: Mahogany Net 69.00
Blonde Net 76.00
Walnut Net 79.80
ARISTOCRAT KD6 "Do-It-Yourself" Enclosure Kit Net 39.00
- 2 Model BB1 Speaker Building Block System Net \$34.50
- 3 Model BB3 Speaker Building Block System Net \$83.50

Electro-Voice, manufacturer of the most complete high-fidelity product range—speakers, speaker enclosures, speaker systems, amplifiers, preamps, tuners, phono cartridges, do-it-yourself enclosure kits and microphones. Available everywhere.

WRITE FOR CATALOG No. 118 N73

Don't spend a dime until...



you've heard the difference between a single speaker and a multi-way speaker system. Unique E-V Systems Selector lets you dial the system you want to hear. In advance, hear how each added speaker component enhances the illusion of musical reality. Dial the difference at your Electro-Voice Hi-Fi Dealer!

HI-FI "BUDGET-BLUES"?...

BANISH THEM WITH THE ELECTRO-VOICE SPEAKER

BUILDING BLOCK PLAN

- 1. Start with the Electro-Voice Model SP12B 12-inch Two-Way Radax Coaxial Loudspeaker (response 30-13,000 cps) and the ARISTOCRAT Enclosure.
- 2. Add, whenever your budget permits, Speaker Building Block 1 . . . T35B Super-Sonax VHF Driver, X36 Crossover Network, and AT37 Level Control with wiring harness. Hear those silky smooth highs. You now have a separate 2-way system.
- 3. Then add Speaker Building Block 3 . . . T10A HF Driver with 8HD Diffraction Horn, X825 1/2-section Crossover Network, and AT37 Level Control with wiring harness. This separate 3-way system gives you more mid-range response and cleanliness of reproduction.

Your hi-fi system has grown one economical step at a time, and you haven't obsoleted any of your original components.

Hear the difference!

AT YOUR ELECTRO-VOICE HI-FI DEALER!

Electro-Voice®

ELECTRO-VOICE, INC., BUCHANAN, MICH.

Canada: E-V of Canada Ltd., 73 Crockford Boulevard, Scarborough, Ontario
Export: 13 East 40th Street, New York 16, U. S. A.

Cables: ARLAB

WE TRADE HIGHER!

WANNA SEE FOR YOURSELF? WRITE TODAY!



BRAND NEW! - FROM JOHNSON
"FIVE HUNDRED" KIT \$649.50 - WIRED \$799.50

WRITE FOR FULL DETAILS ABOUT OUR TIME PAYMENT PLAN

All prices f. o. b. St. Louis • Phone Chestnut 1-1125

Walter Ashe
RADIO CO.
 P. O. BOX 4444 • PLAZA STATION
ST. LOUIS 1, MO.

WALTER ASHE RADIO COMPANY **OUR 35TH YEAR**

Rush "Surprise" Trade-In Offer on my.....
 for.....
 (show make and model of new equipment desired) RN-3-57

Send NEW 1957 Walter Ashe catalog.

Name.....
 Address.....
 City..... Zone..... State.....



FROM DELCO RADIO come the **speakers** with highest performance. You trust them...so do your customers!

Engineering skills of Delco Radio and General Motors combine to offer a full line of speakers for home and auto radios, phonographs, TV, and Hi-Fi. National advertising behind the Delco Wonder Bar Radio develops a bigger service market for you! For fast service call your UMS-Delco Electronics Parts Distributor.

14 Standard Models: Designed and built to R.E.T.M.A. standards with heavily plated metal parts and Alnico-V magnets. Precision felted cones give uniform response over full operating frequency range. All are fully dustproof and dependable.

Dual-Purpose Hi-Fi Model 8007: A superior speaker for custom-built audio systems and for replacements in AM, FM, TV and phonograph sets. Size 8", 50 to 12,500 CPS frequency range; Alnico-V magnet; 10-watt power rating; 4.1 v.c. impedance; 1 $\frac{3}{16}$ " voice coil.

DELCO

WONDER BAR

RADIO

DIVISION OF GENERAL MOTORS, KOKOMO, INDIANA



A GENERAL MOTORS PRODUCT—A UNITED MOTORS LINE
Distributed by Delco Electronic Parts Distributors

A complete line of original equipment service parts from the

WORLD LEADER IN AUTO RADIO

March, 1957

29

BUILD THE BEST— BUILD ALLIED'S OWN knight- kits

ALLIED stakes its 36-year reputation in the Electronics field on your complete success and fullest satisfaction with KNIGHT-KITS. Join the thousands who have discovered the ultimate in kit value in...



knight-kits

LOWEST COST because our giant buying power passes biggest savings on to you... you do the easy assembly and your finished instrument is equal in performance and appearance to equipment selling for several times the KNIGHT-KIT cost. (Easy Payment Terms available, too.)



knight-kits

EASIEST TO BUILD because KNIGHT-KIT "Step-and-Chek" instruction manuals are marvels of clarity—it's just like having a good instructor at your side. Proved professional design and premium quality parts help insure your building success.



knight-kits

MONEY-BACK GUARANTEE: When properly assembled, KNIGHT-KITS fully meet published specifications, or we refund your money.

WHEN YOU BUILD A KNIGHT-KIT
YOU BUILD THE BEST



For a Complete Selection of
Famous knight-kits

SEE PAGES 127-133

Available Only From

ALLIED RADIO

100 N. Western Ave., Chicago 80, Ill.

Within the Industry



GAYLORD RUSSELL has been promoted to head the Audio Development Division of *Heath Company*, as announced by Robert Erickson, president of the firm.



He joined the organization, a subsidiary of *Daystrom, Incorporated*, in 1952, and worked for a short period of time as technical correspondent before becoming a project engineer. In his present capacity he will report to E. C. Fiebich, director of engineering.

Mr. Russell previously held the position of engineer with station WAPG in Ann Arbor, Mich., and worked as a technician at the University of Michigan Research Center at Willow Run. He is a graduate of the Valparaiso Technical Institute and attended Wittenberg College.

INSTITUTE OF HIGH FIDELITY MANUFACTURERS INC. has announced the establishment of credit and catalogue committees, according to George Silber of *Rek-O-Kut Co.*, president of the Institute.

The credit committee will study methods for establishing a credit information service for members of the Institute. The advisability of a syndicated industry-wide catalogue will be considered by the catalogue committee.

Ben L. Arons of *Fisher Radio Corp.* has been appointed chairman of the credit committee, and the catalogue committee is headed by Milton Thalberg of *Audiogersh Corp.*

The executive secretary of the Institute is Sanford L. Cahn, P. O. Box 284, Mineola, N. Y.

PHILIP J. WOOD has been appointed sales manager, radios and phonographs, for *Zenith Radio Corporation*.



In his new assignment, he will work with the company's field sales organization and also with wholesale distributors in the development of high-fidelity and phonograph sales volume.

Mr. Wood joined the organization in 1955 as assistant to the vice-president in charge of radio and television sales. Previously, he was distributor sales manager of *Stewart-Warner Electric*, a division of *Stewart-Warner Corporation*.

He is a graduate of Ohio State Uni-

versity with a degree in business administration.

BRAND NAME SURVEYS of Chicago is now conducting its fourth annual survey of brand preferences in electronic components.

Starting in February of this year, questionnaires were mailed to more than 20,000 radio and television service technicians throughout the United States, requesting information on their brand preferences for a number of electronic replacement components. They are also being asked to indicate, where applicable, the reasons for these preferences.

The survey results will be used by the manufacturers who are participating in the survey as a means of improving their products and making them easier for the service technician to use.

SAMUEL R. BRENTNALL has been named vice-president and assistant general manager, Military Electronics Division, *Motorola Inc.*



Major General Brentnall, U. S. Air Force, retired, will make his headquarters at the company's Western Area Military Electronics Center in Phoenix, Ariz., where he will supervise military electronics operations in Phoenix, Riverside, California, and Chicago.

He is a graduate of West Point, the Air Corps Advanced Flying School, and Air Corps Engineering School. He holds an M.S. degree in engineering from Stanford University.

MAGNETIC AMPLIFIERS, INC. announces the formation of its new West Coast Division at 136 Washington Street, El Segundo, Calif. . . . New offices and facilities for the **P. R. MALLORY & CO. INC.**, Distributor Division are now located at 1302 East Washington Street, Indianapolis, Ind. . . . **GENERAL ELECTRIC COMPANY** has announced that it will convert its 175,000 square foot Buffalo, N.Y. television picture tube plant to the manufacture of transistors early this year . . . **RONETTE ACOUSTICAL CORP.** recently acquired the building at 190 Earle Avenue, Lynbrook, N. Y. The ten thousand square foot plant will be used for the assembly of phonograph cartridges, tone arms, and microphones . . . The Scientific Instruments Division of **BECKMAN INSTRUMENTS, INC.** has announced the leasing of a new 20,000 square foot plant in Anaheim, Calif. . . . **AMPEX CORPORA-**

**the world's finest mast
at today's lowest prices!**

... because only Channel Master
manufactures telescoping masts
in its own steel tubing mill.

CHANNEL MASTER® **new SUPER-MAST**

Packed with new features that reduce installation
time...cut costs...deliver sturdier antenna support—
with the greatest convenience and safety.

NEW! EXCLUSIVE! DUAL T-NUT CLAMP

— saves time, cuts costs

Dual Clamp has 2 T-Nuts to accommodate standout insulator and locking bolt. Eliminates nuisance and cost of additional nut buckle straps.

NEW! EXCLUSIVE! FREE TURNING GUY RING AND BEARING FOR EACH SECTION

— can never bind or jam

Extra large square guy ring for greater stability.

COMPLETELY INTERLOCKED

Can't pull out! Each mast section has swaged neck, expanded bottom.

Can't slip down! Each mast section rests on a heavy-duty cotter "platform" pin. Bottoms are notched to automatically align locking-bolt holes.

Can't twist or turn! Sections are securely locked in place by a sturdy L-Bolt with man sized lever that makes it easier to tighten without tools.

EASY TO TAKE DOWN!

Both the Dual T-Nut Clamp and Guy Rings are positioned below each joint. This allows the mast to be completely collapsed without removing the clamp or the standout insulator, and without jamming.

see your **CHANNEL MASTER** distributor

**Now Channel Master offers
you the widest selection in TV wire.**

- New UHF Tubular Transmission Wire
- New 4-Conductor Rotor Wire
- New Low Priced Addition to VHF Flat Ribbon Transmission Line
- New Hank Packaging— 50', 75', 100'



HOT-DIPPED GALVANIZED

ZINC-COATED *inside and out*

Available
in 20, 30,
40, and 50
foot models.
All models
are 16 gauge
for top 2
sections.

Also Available
Straight-Away
telescoping mast
for economy
installations.

CHANNEL MASTER EXTENDS MASSIVE NATIONAL ADVERTISING CAMPAIGN

MILLIONS OF AMERICANS WILL CONTINUE TO
READ AND REMEMBER CHANNEL MASTER LARGE
SIZE ADS IN AMERICA'S LEADING PUBLICATIONS.



CHANNEL MASTER CORP. ELLENVILLE, N. Y.
the world's largest manufacturer of television antennas and accessories

copyright 1957 Channel Master Corp.

®-Trade Mark Reg. U.S. Pat. Off.



UNI-DIRECTIONAL

"MONOPLEX"

MODEL 737A



SEMI-DIRECTIONAL

"SONODYNE"

MODEL 51

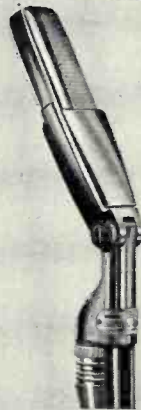

BI-DIRECTIONAL

"GRADIENT"

MODEL 315

You have your choice of three

SHURE

moderately priced general-purpose microphones

Where quality is essential, yet cost is a factor—you can rely on these SHURE Microphones

FOR PUBLIC ADDRESS • HOME RECORDING • COMMUNICATIONS • PAGING AND INTERCOM SYSTEMS

MODEL 737A "MONOPLEX": Uni-directional, moisture-proofed crystal microphone—reduces feedback by 67%! Can be used under adverse conditions of background noise where conventional microphones would be practically useless. "Humi-seal" Crystal for trouble-free operation even in humid climates. High impedance unit with excellent response to 10,000 cps. Output -54.0 db. LIST PRICE \$46.00

MODEL 51 "SONODYNE": Semi-directional, dynamic microphone. Switch for low, medium, or high impedance makes it three microphones in one! Ideal for recording and "close-talking" applications. Frequency response is 60-10,000 cps, Output -52.5 db. Unusually rugged microphone; can be used in any climate, indoors or outdoors. LIST PRICE \$49.50

MODEL 315 "GRADIENT": Bi-directional high fidelity microphone with multi-impedance switch. Picks up sound equally from front and rear; is "dead" at sides. Ideal for interview broadcasting or group recording. Frequency response 50-12,000 cps. Provides exceptional voice and music reproduction. Particularly useful in installations where feedback is a problem. Output -57 db. LIST PRICE \$85.00

All three units have rugged, die-cast metal cases and are finished in a rich satin chrome.

SHURE BROTHERS, INC.

Microphones ~ Electronic Components

210 HARTREY AVENUE • EVANSTON, ILLINOIS

"In Electronics Since 1925"

TION, manufacturers of magnetic tape recorders, announces that a new \$350,000 building is under construction and will be leased to the company to house its expanded production facilities.

* * *

LOUIS W. SELSOR has been appointed to the post of general sales manager of *Electro-Voice, Inc.*, Buchanan, Mich.

His new duties and responsibilities will entail coordinating and supervising the entire product line which includes microphones, high-fidelity speaker systems and components, phonograph cartridges, public address loudspeakers, and ham equipment.

Mr. Selsor joined the company after serving as distributor sales manager at the *Jensen Manufacturing Company*.

* * *

SIGHTMASTER CORPORATION of New Rochelle, N. Y. has acquired MUTUAL ELECTRONIC INDUSTRIES CORPORATION. Both companies have manufacturing facilities at New Rochelle.

* * *

L. H. JOSEFSON has been appointed general sales manager of the Industrial Electronics Division of *Telex Laboratories*, manufacturers of miniaturized electronic components and assemblies.

Prior to his joining this organization, he was manager of research for *Superior Separator Company* and a member of the product development staff for *General Mills Mechanical Division*. He has wide and varied experience in product design and marketing.

Mr. Josefson is a graduate of the University of Michigan.

* * *

DR. CLARENCE ZENER has been appointed director of the Research Laboratories of *Westinghouse Electric Corporation* . . . *RCA Components Division* has announced the appointment of MAX E. MARKELL as manager of equipment sales . . . ALBERT W. ONDIS has been named eastern regional manager for *Brush Electronics Co.*, division of *Clevite Corporation* . . . FRANK D. LINTERN has been appointed assistant distributor sales manager of *Electro-Voice, Inc.*, and C. E. (PETE) SEAMAN has been named sales manager of "Power-Point" phonograph cartridges . . . HARRY R. CLARK has joined *Westbury Electronics Inc.* as assistant to the president and general sales manager . . . *Stromberg-Carlson*, division of *General Dynamics Corp.*, has announced the following advancements: SIDNEY R. CURTIS, senior vice-president; GEORGE A. PECK, vice-president and general manager of the electronics division; GEORGE E. EYER, vice-presi-

(Continued on page 158)

NEW! 12-WATT Williamson-type HIGH FIDELITY INTEGRATED AMPLIFIER HF12



with Preamplifier, Equalizer & Control Section
KIT \$34⁹⁵ WIRED \$57⁹⁵

Compact, beautifully packaged & styled. Provides complete "front-end" facilities and true high fidelity performance. Direct tape head & magnetic phono inputs with NARTB (tape) & RIAA (phono) feedback equalizations. 6-tube circuit, dual triode for variable turnover bass & treble feedback-type tone controls. Output Power: 12 w cont., 25 w pk. IM Dist. (60 & 6000 cps @ 4:1): 1.5% @ 12 w; 0.55% @ 6 w; 0.3% @ 4 w. Freq. Resp.: 1 w: ± 0.5 db 12 cps - 50 kc; 12 w: ± 0.5 db 25 cps - 20 kc. Harmonic Dist: 20 cps: 2% @ 4.2 w; 1/2% @ 2.5 w; 30 cps: 2% @ 11 w; 1/2% @ 6.3 w; 40 cps: 1% @ 12 w; 1/2% @ 9.3 w; 2000 cps: 1/2% @ 12 w; 10 kc: 1% @ 10 w; 1/2% @ 6 w. Transient Resp: excellent square wave reproduction (4 μ sec rise-time); negligible ringing, rapid settling on 10 kc square wave. Inverse Feedback: 20 db. Stability Margin: 12 db. Damping Factor: above 8, 20 cps - 15 kc. Speaker Connections: 4, 8, 16 ohms. Tone Control Range: @ 10 kc, ± 13 db; @ 50 cps, ± 16 db. Tubes: 2-ECC83/12AX7, 1-ECC82/12AU7, 2-EL84, 1-EZ81. Size: HWD: 3 3/8" x 12" x 8 1/4". 13 lbs. COMING SOON

NEW! 50-WATT Ultra-Linear HIGH FIDELITY POWER AMPLIFIER

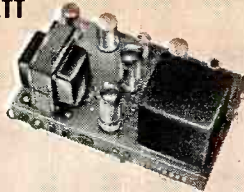

HF50 KIT \$57⁹⁵ WIRED \$87⁹⁵

Like the HF60 shown below, the HF50 features virtually absolute stability, flawless transient response under either resistive or reactive (speaker) load, & no bounce or flutter under pulsed conditions. Extremely high quality output transformer with extensively interleaved windings, 4, 8, & 16 ohm speaker connections, grain-oriented steel, & fully potted in seamless steel case. Otherwise identical to HF60. Output Power: 50 w cont., 100 w pk. IM Distortion (60 & 6000 cps @ 4:1): below 1% at 50 w; 0.5% @ 45 w. Harmonic Dist.: below 0.5% between 20 cps & 20 kc within 1 db of rated power. Freq. Resp.: ± 0.5 db 6 cps -60 kc; ± 0.1 db 15 cps -30 kc at any level from 1 mw to rated power; no peaking or raggedness outside audio range. All other specs identical to HF60 below.

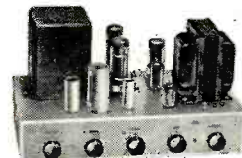

NEW! 50-WATT Ultra-Linear HIGH-FIDELITY

INTEGRATED POWER AMPLIFIER HF52 with Preamplifier, Equalizer & Control Section
KIT \$69⁹⁵ WIRED \$109⁹⁵

Combines a power amplifier section essentially identical to the HF50 power amplifier with a preamp-equalizer control section similar to HF20 below. Provision for use with electronic crossover network & additional amplifier(s). See HF50 for response & distortion specs; HF60 for square wave response, rise-time, inverse feedback, stability margin, damping factor, speaker connections; HF20 for preamplifier, equalizer & control section description. Hum & noise 60 db below rated output on magnetic phono input (8 mv input for rated output), & 75 db below rated output on high level inputs (0.6 v input for rated output).

The specs are the proof...
7 NEW BEST BUYS by



NEW HIGH FIDELITY PREAMPLIFIER

#HF61A KIT \$24⁹⁵, WIRED \$37⁹⁵

With Power Supply: #HF51 KIT \$29⁹⁵, WIRED \$44⁹⁵

Will not add distortion or detract from the wide-band or transient response of the finest power amplifiers at any control settings. High quality feedback circuitry throughout plus the most complete control & switching facilities. Heavy-gauge solid brushed brass panel, concentric controls, one-piece brown enamel steel cabinet for lasting attractive appearance. Feedback-type, sharp cut-off (12 db/octave) scratch & rumble filters. Low-distortion feedback equalization: 5 most common recording curves for LPs & 78s including RIAA. Low-distortion feedback tone controls: provide large boost or cut in bass or treble with mid-freqs & volume unaffected. Centralab printed-circuit Senior "Compentrol" loudness control with concentric level control. 4 hi-level switched inputs (tuner, tv, tape, aux.) & 3 low-level inputs (separate front panel low-level input selector permits concurrent use of changer & turntable). Proper pick-up loading & attenuation provided for all quality cartridges. Hura bal. control. DC superimposed on filament supply. 4 convenience outlets. Extremely flat wideband freq. resp.: ± 1 db 8-100,000 cps; ± 0.3 db 12-50,000 cps. Extremely sensitive. Negligible hum, noise, harmonic or IM distortion. Size: 4-7/8" x 12-5/16" x 4-7/8". 8 lbs.

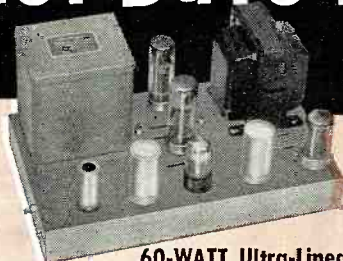

NEW 60-WATT Ultra-Linear HIGH FIDELITY POWER AMPLIFIER #HF60 with ACRO TO-330 OUTPUT TRANSFORMER
KIT \$72⁹⁵ WIRED \$99⁹⁵

Superlative performance, obtained through finest components & circuitry. EF86 low-noise voltage amplifier direct-coupled to 6SN7GTB cathode coupled phase inverter driving a pair of Ultra-Linear connected push-pull EL34 output tubes operated with fixed bias. Rated power output: 60 w (130 w peak). IM Distortion (60 & 6000 cps at 4:1): less than 1% at 60 w; less than 0.5% at 50 w. Harmonic Distortion: less than 0.5% at any freq. between 20 cps & 20 kc within 1 db of 60 w. Sinusoidal Freq. Resp.: at 1 w: ± 0.5 db 5 cps - 100 kc; at 60 w: ± 0.1 db 15 cps to 35 kc at any level from 1 mw to rated power; no peaking or raggedness outside audio range. Square Wave Resp.: excellent from 20 cps to 25 kc, 3 μ sec rise-time. Sensitivity: 0.55 v for 60 w. Damping Factor: 17. Inverse Feedback: 21 db. Stability Margin: 16 db. Hum: 90 db below rated output. ACRO TO-330 Output Transformer (fully potted). Speaker Taps: 4, 8, 16 ohms. GZ34 extra-rugged rectifier (indirectly-heated cathode eliminates high starting voltage on electrolytics & delays B+ until amplifier tubes warm up). Input level control. Panel mount fuse holder. Both bias and DC - balance adjustments. Std octal socket provided for pre-amplifier power take-off. Size: 7" x 14" x 8". 30 lbs. Matching cover Model E-2 \$4.50.

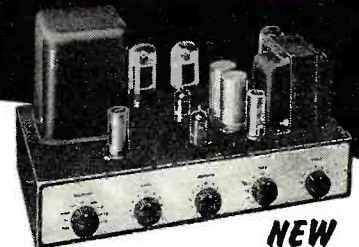

NEW COMPLETE with Preamplifier, Equalizer & Control Section 20-WATT Ultra-Linear Williamson-Type HIGH FIDELITY AMPLIFIER #HF-20
KIT \$49⁹⁵ WIRED \$79⁹⁵

A low-cost, complete-facility amplifier of the highest quality that sets a new standard of performance at the price, kit or wired. Rated Power Output: 20 w (34 w peak). IM Distortion (60 & 6000 cps/4:1) at rated power: 1.3%. Max. Harmonic Distortion between 20 & 20,000 cps at 1 db under rated power: approx. 1%. Mid-band Harmonic Distortion at rated power: 0.3%. Power Response (20 w): ± 0.5 db 20-20,000 cps; ± 1.5 db 10-40,000 cps. Freq. Resp. (1/4 w): ± 0.5 db 13-35,000 cps; ± 1.5 db 7-50,000 cps. 5 feedback equalizations for LPs & 78s. Low-distortion feedback tone controls: large boosts or cuts in bass or treble with mid-freqs, & volume unaffected. Loudness control & separate level set control on front panel. Low Z output to tape recorder. 4 hi-level switched inputs: tuner, tv, tape, aux.; 2 low-level inputs for proper loading with all cartridges. Hum bal. control. DC superimposed on filament supply. Extremely fine output transformer: interleaved windings, tight coupling, careful balancing, grain-oriented steel. 8 1/2" x 15" x 10". 24 lbs. Matching cover Model E-1. \$4.50.

See us at Booth 3407
IRE SHOW

NEW COMPLETE with FACTORY-BUILT CABINET - 2-WAY HI-FI SPEAKER SYSTEM #HF51 \$39⁹⁵

See the "BEST BUYS" NOW IN STOCK at your nearest distributor. Fill out coupon on other side for FREE CATALOG.

Prices 5% higher on West Coast.



Genuine 2-way book-shelf size speaker system. Jensen heavy duty 8" woofer (6.8 oz. magnet) & matching Jensen compression-driver exponential horn tweeter with level control. Smooth clean bass & crisp extended highs free of coloration or artificial brilliance. Factory-built tuned bass reflex birch hardwood cabinet (not a kit) constructed to high quality standards. Neutral acoustical grille cloth framed by a smooth-sanded solid birch molding. Freq. Resp. measured 2 ft. away on principal axis in anechoic chamber with 1 watt input - Woofer: ± 4 db 80-1800 cps; Tweeter: ± 2 db 2800-10,000 cps; Crossover Region: 1800-2800 cps, shift in level over this region depends on tweeter level control setting. Power-handling capacity: 25 watts. Size: 23" x 11" x 9". 19 lbs. Working Time: 15 min.

84 Withers Street, Brooklyn 11, N. Y.



Turn page for other EICO ad.

**the specs are
the test that tells
who's best!**

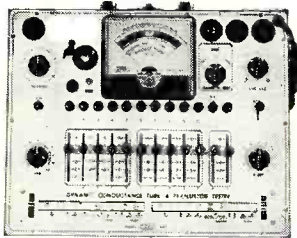

for COLOR & Monochrome
TV servicing

**NEW! DYNAMIC
CONDUCTANCE TUBE &
TRANSISTOR TESTER #666**
KIT \$69.95 WIRED \$109.95

Unexcelled testing thoroughness & accuracy. Checks transistor collector current & Beta using internal dc power supply. Tests all receiving tubes including subminiatures (& Color & Monochrome tv pic tubes with accessory adapter). Composite indication of mutual conductance, plate conductance, & peak emission. Simultaneous sel. of any 1 of 4 combinations of 3 plate, 3 screen, & 3 ranges of control grid voltage. Grid voltage variable over 3 ranges with 5% accurate pot. New series-string voltages for 600, 450 & 300 ma types. 5 ranges meter sens. with 1% precision shunts & 5% accurate pot. 10 SIX-position lever switches for free-point connection of every tube pin or cap. 10 pushbuttons for rapid insert of any tube element in leakage circuit & speedy sel. of individual tube sections. Direct reading of inter-element leakage in ohms. New gear-driven rollchart. Steel case with cover & handle. Sensitive 200 ua meter.

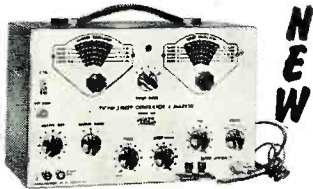

NEW

for COLOR & Monochrome
TV servicing
**TV-FM SWEEP GENERATOR
& MARKER #368**
KIT \$69.95 WIRED \$119.95

The FINEST service instrument of this type ever offered in either kit or wired form at ANY price! Outstanding ease & accuracy in FM & TV (including Color) alignment. Entirely electronic sweep circuit with accurately biased Incredulator: superb linearity on both sides of selected center freq. Newly-designed AGC circuit automatically adjusts osc. for max. output on each band with min. amplitude variations. Sweep gen. range 3-216 mc in 5 OVERLAPPING FUND. BANDS. Sweep width continuously variable from 0-3 mc lowest max. deviation to 0-30 mc highest max. deviation. Variable marker gen. range from 2-75 mc in 3 FUND. BANDS plus a calibrated harmonic band (60-225 mc). Variable marker calibrated with internal marker gen. 4.5 mc xtal included Ext. marker provision. Double pi line filter. Edge-lit hairlines eliminate parallax.

Turn page for other EICO ad



**FREE 1957
EICO CATALOG!**

Tells you how to SAVE 50% on
your test equipment costs!

TUBE TESTER #625
KIT \$34.95
Wired \$49.95

- tests 600 mil series string type tubes
- illuminated roll-chart

Pix Tube Test Adapter\$4.50

VACUUM TUBE VOLTMETER #221
KIT \$25.95
Wired \$39.95

DELUXE VTVM #214 (7 1/2" METER)
KIT \$34.95
Wired \$54.95

#944 FLYBACK TRANSFORMER & YOKE TESTER
KIT \$23.95
Wired \$34.95

- fast check all flybacks & yokes in or out of set.
- spots even 1 shorted turn!

Sep. volt-meter & ammeter
KIT \$29.95
Wired \$38.95

6V & 12V BATTERY ELIMINATOR & CHARGER #1050

PEAK-to-PEAK VTVM #232 & UNI-PROBE (pat. pend.)
KIT \$29.95
WIRED \$49.95

NEW COLOR & Monochrome DC-5 MC LAB & TV 5" OSCILLOSCOPE #460
KIT \$79.95
WIRED \$129.50

RF SIGNAL GENERATOR #320
KIT \$19.95
Wired \$29.95

150 kc-34 mc, calibrated harmonics to 102 mc. Pure or mod. RF, & Colpitts osc. 400 cps sine outputs.

RF SIGNAL GENERATOR #324
KIT \$26.95
WIRED \$39.95

150 kc-435 mc with ONE generator!

Sep. hi-gain RF & lo-gain audio inputs. Special noise locator. Calibrated wattmeter.
KIT \$24.95
Wired \$39.95

DELUXE MULTI-SIGNAL TRACER #147

20,000 Ohms/Volt MULTIMETER #565
KIT \$24.95
Wired \$29.95

1000 Ohms/Volt MULTIMETER #536
KIT \$12.90
Wired \$14.90

5" PUSH-PULL OSCILLOSCOPE #425
KIT \$44.95
Wired \$79.95

7" PUSH-PULL OSCILLOSCOPE #478
KIT \$79.95
Wired \$129.50

NEW! REDI-TESTER #540
KIT \$12.95
Wired \$15.95

Multi-range ac/dc voltmeter, ammeter, ohmmeter, wattmeter, leakage checker for home & auto repairs.

1% accuracy on all 7 ranges. Range 75 kc-150 mc. Volt reg.
KIT \$39.95
Wired \$59.95

DELUXE RF SIGNAL GENERATOR #315

Reads 0.5 ohms -500 megs, 10 mmd-5000 mfd power factor.
KIT \$19.95
Wired \$29.95

R-C BRIDGE & R-C-L COMPARATOR #950B

VTVM PROBES KIT

Peak-to-Peak	\$4.95	\$6.95
RF	\$3.75	\$4.95
High Voltage Probe-1		\$6.95
High Voltage Probe-2		\$4.95

SCOPE PROBES

Demodulator	\$3.75	\$5.75
Direct	\$2.75	\$3.95
Low Capacity	\$3.75	\$5.75

For FREE 1957 catalog, mail coupon NOW!



84 Withers St. • Brooklyn 11, N. Y.

Prices 5% higher on West coast and subject to change without notice.

EICO, 84 Withers Street
Brooklyn 11, New York

R-3

Send FREE 1957 Catalog and name of neighborhood EICO jobber.

Name.....

Home Address.....

City.....Zone.....State.....

Occupation.....

Over a Decade of Know-How & Value Leadership in Kits & Instruments — Over 1 Million Sold to Date!

Before You Call for Service



Check Your Own Hi-Fi System

By

WARREN PHILBROOK

You can save money and reduce the time your hi-fi gear is out of service by making these simple checks in advance.

THIS is not a "do it yourself" article. We are not suggesting that you should service your own high-fidelity equipment, instead of getting the local service dealer to do it. This article aims at helping both the high-fidelity owner-user and the service technician. Let us illustrate with a typical situation.

You are visiting a friend who also happens to be a high-fidelity enthusiast. He has just acquired the latest high-fidelity jazz album with a good piece of trumpet solo on it. You would like to hear how this record sounds on your equipment, so you borrow it from your friend and play it at home. But on your equipment the trumpet solo does not have the same cool sharp clearness it did on your friend's equipment. Apart from that particular place in the recording it sounds pretty good. Returning the disc to your friend you find that no fault has developed on the disc—the difference lies between the two equipments. You conclude (correctly) that your equipment is not quite up to par.

If you call the service dealer in at this stage and tell him your problem, he may well waste fruitless hours trying to find something wrong with the equipment without being able to give you any real satisfaction. He will probably eventually do something to justify making a charge and to try and maintain his reputation, but quite frankly, no one is satisfied.

It is really up to you to do a little tracking down yourself and find out just where the trouble lies. This will involve ability of quite a different kind from your service dealer's. You will

probably need to call the service dealer eventually, but by that time you should know exactly what you need done. You will save his time and your money. Everyone will be pleased and no reputations will suffer.

Rather than pursue the example used for illustration to its fine conclusion, we will outline some of the different defects that may be noticed and what to look for (or listen for) in tracking them down.

Use the Volume Control

As a general principle we can do quite a bit of tracing by a little observation, using the volume control and the program switch. Many defects could equally well occur at different places in your system. They may be at the front end—in the pickup or preamplifier, or in the tuner; or they may be at the output end—in the power amplification stages or the loudspeaker system. The volume control provides a ready means of tracing the trouble this far.

Play the program material on which you notice the trouble at different levels, by adjusting the volume control. If the unwanted sound is still present when the control is turned down, and in about the same proportion relative to the program, then the trouble lies *before* the volume control. This means it must be in the pickup or preamplifier, or, if the program comes from radio, it may be in the tuner.

On the other hand, if turning the volume control down a little causes the unwanted sound to disappear rapidly, before the program has re-

duced in level appreciably, the trouble lies—*after* the volume control—in the later end of the system, the power amplifier or the loudspeaker. If turning the volume control up a little causes the unwanted sound to become much more exaggerated, this confirms the diagnosis.

The Program Switch

If the trouble appears to be in the front end the next step can be to determine whether it is in the part of the channel that is common to the whole system or whether it comes from just the phono or tuner section. This, of course, only applies if you have more than one "source," phono and tuner, for example. If your hi-fi happens to be phono only, skip this paragraph. This can readily be determined by using the program switch. If the fault you are looking for is one of these elusive things that only happen on a certain piece of program material, a simple procedure is to wait until this particular piece of program material is played from a radio station. Then you can make direct comparison between the reproduction from the tuner over your system and from your own phono. If it only shows on your phono, the trouble must be either in your copy of the disc or in your phono section. If it shows on both, the trouble may be on all copies of the disc, or in a later section of your system, *after* the program switch.

Either way, it is always a good plan where the defect only shows on a particular program item to check the quality of the item. With a disc, this can be done easily by playing the same

disc over someone else's equipment. There is no point in searching for trouble in your system if the defect happens to be in the recording.

Having dealt with these generalities, we will now consider specific kinds of defect.

1. *Knocking or rattling*: By this we mean the kind of sound a loudspeaker makes when it is overloading, so that the voice coil knocks against whatever prevents it going any farther when it reaches its maximum excursion. It can be this, but there are other faults in a system that give similar sounds. If the loudspeaker itself is causing the sounds, it will be particularly associated with the lowest frequency—very deep bass tones.

Large outputs higher up in the frequency range do not move the voice coil sufficiently to cause the same knocking as the low or extreme bass frequencies do. So, if the knocking sound occurs in the middle or higher register as well, then the fault is probably not in the loudspeaker but somewhere else.

If it proves to be associated with the output end, the most likely defect is one of the output tubes having gone bad in a push-pull amplifier. Under this condition the amplifier will give less than half its usual maximum output, which will probably be insufficient to drive the loudspeaker without producing the knocking sound from the amplifier. A feedback type amplifier, particularly, causes a knocking sound very like a loudspeaker overloading, except that it occurs not only at the low frequencies, but also at the middle frequencies.

If the trouble proves to be before the volume control, it is unlikely (but not impossible) for it to be in the pre-amplifier, because a fault in the pre-amplifier usually makes more distortion than just a knocking sound. It is more likely to be in the pickup. Good pickups are provided with safeguards against excessive stylus movement causing damage, which could occur, for example, by rough handling in lowering the pickup into the groove. The pickup may have gone out of adjustment so that the stylus knocks against this guard in normal play, producing a knocking sound in the reproduced program.

2. *Buzzing*: The sound we mean here is characteristic of that produced when a loudspeaker grille cloth is loose, so that it can vibrate against something. Usually some particular frequency will set the grille cloth vibrating and where it loosely touches something this will cause a buzz. If this is the actual trouble, it is something you can probably fix yourself by anchoring the grille cloth in some suitable manner, or removing whatever it is that causes the buzz.

A similar sound can also be caused by various other things in the loudspeaker itself. This can be checked by the volume control method. If the trouble is associated with the loudspeaker, the best thing to do is to play



the program material that caused the buzzing over the system and examine very closely to see just what is causing it. As one example, there may be an air leak in the enclosure with a small splinter of wood hanging in it. At the particular frequency causing the buzzing, the resonance effect in the leak, or in the vibration of the wood splinter, causes the buzzing sound. If you can make the buzzing occur repetitively, you should be able to track it down by ear.

If the fault proves to be before the volume control, the most likely place is the pickup. A defective stylus can cause this kind of sound, either by the stylus arm not being correctly mounted in the pickup, or by the stylus itself not being rigidly mounted to the arm. In modern pickups the stylus is cemented or riveted to the arm. A crack in this cement or a defect in the riveting can cause a buzzing sound on the reproduction. If you are using the metal type stylus instead of the diamond or sapphire, it is not unknown for the stylus tip itself to become cracked, which will also produce a buzzing sound, even before the point is appreciably worn. However, this defect can readily be checked by putting in a new needle.

There is another kind of sound that gives the impression of being a buzz but instead of being associated with any single tones it always occurs with a particular kind of musical chord. You will notice this kind of unwanted sound particularly when minor chords are being played. If the buzz you notice occurs when the program material is in a minor key but not with program material using major chords, the trouble is very likely to be a form of intermodulation.

Careful listening will show that this is not really a buzz at all, but a spurious tone of much lower frequency than the chord being played. It is due to distortion somewhere in the system that may not show up on other kinds of program material. Due to this distortion, extra tones are set up which do not fit in with the pattern of the minor chord. With most major chords the extra tones practically fit in with

the pattern and so the effect is not so noticeable, unless the distortion is really serious.

It can come from the loudspeaker if the voice coil has got out of position in the airgap, so as not to be moving in a constant magnetic field. Of course, if the loudspeaker is not well designed in the first place, it does not need to get out of position to cause this effect! A useful test to find whether it is in the loudspeaker, if you have a multiple unit system, is to disconnect the woofer unit. The "buzz" frequency will usually be in the range that should come from the woofer unit. But if it is caused in the loudspeaker, the buzz will usually come from the mid-range unit. So if disconnecting the woofer stops the buzz effect, the trouble is not in the loudspeaker, but if it does not stop the buzz effect your trouble is the mid-range unit.

If it is not in the loudspeaker, you can apply the volume control test to further track down the fault. It may prove to be in the preamplifier or the main amplifier. From there on the job is one for the service shop and the defective unit should be handed over for more careful tests.

3. *Crackles*: This kind of sound gives the impression of a loose electrical connection. This is, in fact, quite a likely cause. It would be good to check up your connections especially where you use the phono type jacks. Make sure that all are a good tight fit and that, where shielded lead is used, there is not a fracture in the shielding that could cause this trouble.

Another cause of this kind of interference is a faulty volume control, due to the slider not making good contact with the composition on which it should ride. In this case turning of the volume control, to change the gain, will be accompanied by even more crackling than occurs during the playing of the program material. Turning the volume control will be accompanied by a virtual roar. Best get the local service technician to replace your volume control.

4. *Crackles and jingles*: The kind of crackling we considered in the previous section is one that goes on more



or less continuously or regularly. But there is another kind that only happens with a particular kind of program material—maybe on the selected program we used as an illustration at the beginning of the article. There is, in fact, a variety of buzzes, crackles, and jingles that high-fidelity systems can introduce into program material, only on particular kinds of recorded sound. These are all due to different kinds of, what the experts call, intermodulation.

The difference from the buzz or spurious tones mentioned in Point 2 is that the cracking or jingling kind of intermodulation distortion is caused by a kind of program given the name "transient." This is a technical word to describe the fact that the form of the sound wave is changing, not like the steady tone, for example, from an organ. Percussion instruments are particularly liable to set up this kind of unwanted sound—the xylophone, marimba, drums, and similar instruments.

Obviously the instruments just mentioned produce sudden sounds rather than (or as well as) continuous tones. But the trumpet and other wind instruments can also produce a similar effect, due to the presence of sounds that are caused by blowing the instrument. When you hear a good clear trumpet reproduction, the special trumpet character it has is partly due to the fact that the instrument is blown. You may even hear a kind of "windy" sound due to the way the instrumentalist blows. These are fluctuations in the program sound and they, too, can sometimes set up this kind of spurious noise in the system.

This fault is seldom in either the pickup or the loudspeaker and will usually be tracked down to part of the amplifier. This kind of defect does not usually *develop* in an amplifier but is usually a weakness in the design. Most probably it has always been that way, but you did not notice it until a particular piece of program made it especially evident. The best thing to do, having found out what part of your system (preamp or main amp) is causing the trouble, is to start looking for a better replacement for this section of your system, making sure of course

that the new component does not produce the same kind of defect.

Incidentally, in choosing for this purpose, don't let the price fool you: some very expensive amplifiers cause this kind of trouble and some quite reasonably priced ones don't.

5. *Wavering*: The defect we mean here can best be described as being like a person talking when he needs to clear his throat. A particular form of it is sometimes noticed on recordings of organ music, where the large pipes are used. When the deep notes are played loud and other parts of the organ are being used at the same time, the rest of the program material has this frog-in-the-throat effect. This is due to intermodulation distortion of yet another kind. Its cause can be located by the volume control test.

Single unit loudspeakers are more liable to this type of distortion than multiple unit loudspeakers—in fact it will very seldom occur in a multiple unit loudspeaker. So if the trouble proves to be at the output end, it is most likely due to a defective tube in the output stage of a push-pull amplifier.

If it is at the front end, it is more likely due to a defective pickup, or a defective detector in a tuner, as the case may be. Operation at incorrect bias, of any of the voltage amplifier stages, can also cause this trouble in an amplifier. Having localized the trouble to one particular component of your system, turn the defective unit over to your service technician to check up for correct performance and put the matter right.

A similar effect can occur, without the necessity for low frequencies being present, due to other causes. One is the use of a 1 mil stylus on the 3 mil 78 rpm records. This allows the stylus to wander about in the groove, sometimes contacting the walls and sometimes "floating" in the middle. This should be an obvious defect, but it is a mistake that is easily made in these days of flipover cartridges. Make sure you haven't overlooked turning the cartridge over to play a 78 rpm disc.

There are two other possible causes of a similar kind of sound that are not

associated with the program itself (that is, they do not need a low-frequency tone to produce the effect). A power amplifier using push-pull output can cause this trouble because of deterioration in the power supply, either the high voltage or the bias supply (where fixed bias is used). In this case the wavering will be present at whatever level the program is reproduced and on all kinds of program material.

It can also be caused by a defect in the turntable drive, due to fairly rapid speed fluctuations. As a check on this put a strobe disc on the turntable while the record is playing and observe the pattern very carefully. The kind of speed variation that causes wavering is not a slow fluctuation that will cause the pattern to move back and forth slowly. It will be a rapid back and forth fluctuation that will make the pattern appear unsteady. Having tracked down the trouble, this again is a job for an expert.

The slow speed fluctuation in pitch, known as wow, is pretty obvious. It is bound to be due to the speed of the turntable varying slowly, perhaps once every revolution. This can easily be seen with a strobe disc too, because the pattern will fluctuate back and forth during every revolution.

In checking for these last two faults notice whether the pattern does stand still, indicating that the speed is correct. If the speed has gone slow or fast causing the pattern to drift one way, it is probable there is a defect in the drive. Usually, when the pattern stands stationary, the drive is in fairly good shape and less likely to produce any serious flutter or wow.

6. *Rumbling*: This is a low-frequency rumbling sound that may come either with the program material or separate from it. This is, in fact, the best way to find out where the trouble lies. If the rumble occurs as soon as the stylus touches the disc, it is probably due to a defect in the drive. Possibly the shock absorbing material used to mount the motor for the turntable drive has deteriorated or perished, allowing the vibration to be transmitted to the table. This will be picked up by the stylus in the same way as modulation in the groove and will appear as rumble from the loudspeaker. It will be particularly noticeable when the stylus is riding an unmodulated groove, such as the run-in or run-out groove of a disc.

Sometimes the rumble will only appear on loud passages of program material, and will disappear when the volume control is turned down anyway. This will usually be due to a form of acoustic feedback. The loudspeaker, possibly, is shaking the floor and the floor, in turn, is shaking the turntable, producing the rumble effect. The cure here is to secure acoustic insulation to this vibration frequency. Take the turntable further away from the loudspeaker, or make sure the phono assembly is mounted in suitable

(Continued on page 87)

Problems in Metropolitan TV Reception

By
SIMON HOLZMAN
Chief Antenna Engineer
JFD Manufacturing Co., Inc.

Fringe areas have no monopoly on difficulties with picking up good signal. Overload, ghosting, and interference often plague prime-signal locations.

WHILE considerable attention has been given to the reception difficulties encountered in areas distant from TV transmitting points, one sometimes forgets that television installations in metropolitan and other primary areas often suffer from problems peculiar to these locations. Noteworthy among these problems are those of ghosting, graininess, the effects of too much (or too little) signal, crossmodulation, and interference from a number of sources. In some cases, these conditions can be completely controlled. In cases where they cannot be entirely eliminated, they may be greatly minimized, as a rule, resulting in satisfactory reception.

In many localities, ghosting is a serious deterrent to acceptable viewing. This phenomenon is caused by the simultaneous reception of out-of-phase signals on the same channel. High-frequency TV waves are capable of being reradiated (as in radar) by metallic bodies. The body reradiating these waves acts as a secondary transmitting antenna and effectively "bounces" the signal in a different direction. The action of two such reflecting bodies is illustrated in Fig. 3. Since the bounced wave and the original signal travel different distances before arriving at the receiving antenna, they are out-of-phase. The phase differential governs the degree of separation of the two pictures on the screen.

To understand the cure, let us in-

vestigate two properties of receiving antennas. The first of these, the front-to-back ratio, is the ratio of the received voltage from the front of the array to the signal received from the rear, given equal power densities in both cases. The higher the front-to-back ratio, the less signal the antenna will receive from reflections coming in from in back of it.

The second property is the antenna's polar response. This has to do with the directivity of the antenna with respect to a signal from one source. It is determined by the angle formed between the direction or position in which the antenna is most sensitive (forward pickup) and the direction or position in which it receives 3 db, or 30 per-cent, less signal from the same source. This may be measured by beaming a constant signal toward the antenna while the latter is aimed directly at the transmitting source, measuring the signal voltage generated in the antenna, and then rotating the antenna without changing the position until the antenna is in a position where the signal generated in it is 3 db down.

In actual practice, this property is of interest because it describes the relative sensitivity of the antenna to signals coming in from different directions. One signal, for instance, may be an unwanted ghost. In Fig. 4 we see the effect of a wide polar pattern (A) and a narrow one (B) in picking up or rejecting such a ghost. In the for-

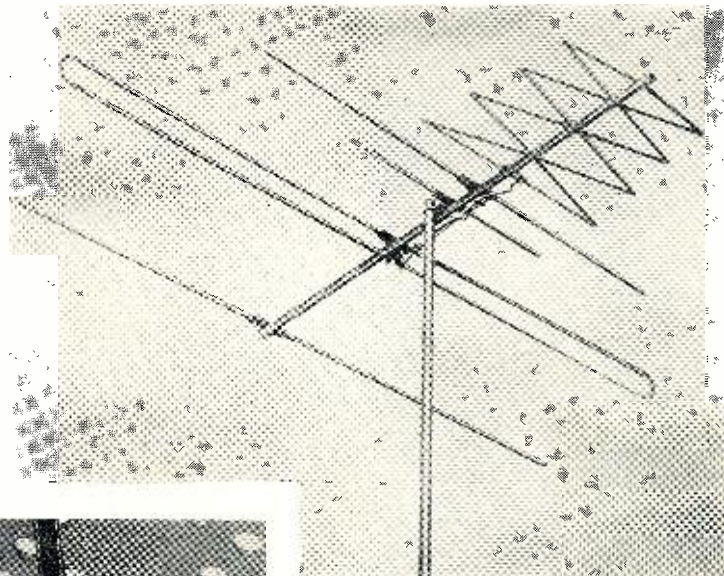

Fig. 1. The JFD "Super Helix" is an example of an antenna with a narrow polar angle (see Fig. 4B) that weakens ghosts.

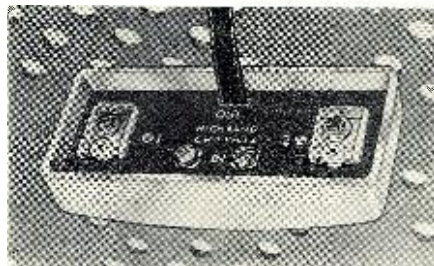

Fig. 2. Some interference can be tuned out with a receiver-installed high-"Q" frequency-selective adjustable trap.

mer case, pickup of the ghost is almost as great as that of the primary signal. In the latter case, the angle at which the ghost comes in is outside the polar response angle, or 3-db point, and is sufficiently weaker so that its effect on the viewed picture is considerably reduced. This property of an antenna is roughly analogous to selectivity in the receiver's front end. An example of an antenna having a small polar angle, the JFD "Super Helix", is shown in Fig. 1.

Unfortunately, narrow beamwidth goes hand in hand with high gain. Often, the greater signal level, in a primary area, will overload the receiver causing buzz, fuzziness, and tearing. This excess of signal, however, is easily compensated for by the addition of an attenuator pad at the set terminals. This pad may have a fixed value, but it is preferable to use a variable type since the degree of attenuation required will vary with the location. Units of this type are readily available commercially. The use of a pad will also help minimize ghosts by bringing the level of the spurious signal down to a non-visible value. Extreme caution must be exercised in an installation of this type to orient the antenna accurately and to keep horizontal runs of lead-in to a minimum. Horizontal lengths of twin-lead tend to act as signal-collecting devices, and will complicate the original problem.

In many metropolitan locations, extremely high signal levels are prevalent due to the proximity of transmitting and receiving antennas and lack of blocking structures. Too high a signal level can and does cause poor picture quality. The average television set is aligned for maximum bandpass

with an a.g.c. voltage of approximately minus 3 volts. As the signal increases, the a.g.c. level goes up, shifting the grid characteristics of the r.f. and i.f. amplifier tubes that are controlled. When this occurs, each of these tubes operates on a different portion of its curve, and its effective input capacitance changes. This, in turn, causes deterioration of the bandpass characteristic of the set, as shown in Fig. 5, and coarse, hazy pictures with poor definition may result. There is also a tendency to poor synchronization due to pre-triggering of the sweep oscillators. This condition may be eliminated by the same attenuator pad mentioned previously. The pad should be adjusted for a barely sufficient signal on the weakest channel. If some channels are still overloaded, a switch type pad should be used, so that it may be switched into the antenna system only on those channels where it is needed.

Crossmodulation, or windshield wiper, is another symptom of too much signal. It usually manifests itself as a dark vertical bar sweeping horizontally back and forth through the picture. This particular trouble is usually caused by a single channel much stronger than the others. TV tuners are rarely selective enough to eliminate this annoying feature particularly on channels adjacent to overly strong ones.

If all channels are sufficiently powerful, an attenuator pad may be used to reduce the over-all signal level. A preferable method, however, is to install an adjustable high-"Q" trap in the lead-in, and set it for sufficient attenuation of the undesired channel. This is the equivalent of a frequency-selective attenuator. These adjustments are usually quite critical, and care should be taken when they are made. The interfering channel can be identified by turning the channel selector to the unused channel positions, and noting which channel is most often seen. A commercial version of such an attenuator that may be adjusted for rejection on the high v.h.f. band is shown in Fig. 2.

In an urban area, there are many sources of interference. Interference caused by amateur radio transmitters is usually of a frequency below 50 megacycles. This, as a rule, can be eliminated by the use of a high-pass filter. This type of filter should be installed as close to the set's antenna terminals as possible, so that there will not be pickup of interference along the lead-in wire beyond the filter.

The previously mentioned selective high-"Q" traps will be of great use in removing interference caused by powerful local FM transmitters.

Pulse-type interference, one form of which is ignition noise is often the most difficult type to eliminate. In its milder forms, putting a tight twist in the downlead may be sufficient to minimize it. Care should be taken in the original installation to keep the antenna and lead-in as far as possible

from sources of ignition noise. Grounded metal screening, used to shield the antenna from the street or other source of ignition noise, is often used with considerable success.

In exceptionally noisy areas, shielded 300-ohm twin-lead or coaxial cable should be used. The outer shield should be grounded at as many points as possible. When using 75-ohm coaxial cable, a balun impedance transformer must be installed at the top to match the antenna to the characteristic impedance of the line. Another transformer must be used at the set to match the line to the balanced 300-ohm input of the front end.

Both shielded 300-ohm cable and coaxial cable have comparatively high signal loss. For this reason, a moderately high-gain antenna may be needed to compensate for these line losses.

It is often difficult to determine the source and frequency of an interfering signal. A convenient gimmick that the technician can carry with him is a 20-inch length of 300-ohm twin-lead, with lugs attached to one end and the other end cut straight across and left open-circuited. A piece of aluminum foil should be wrapped around the twin-lead for a length of about 2½ inches, as shown in Fig. 6. This forms a capacitively loaded half-wave line. In use, the lugs are attached to the antenna terminals of the set in parallel with the antenna lead-in, which remains connected. The interference is

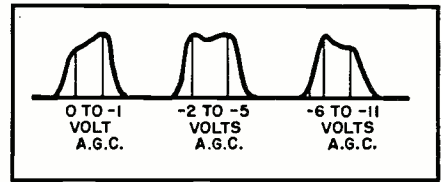

Fig. 5. Receiver i.f. circuits are designed for best response (center trace) over a certain normal range of a.g.c. voltage. Abnormally high signal level (right) can deteriorate performance as much as low signal and a.g.c. values.

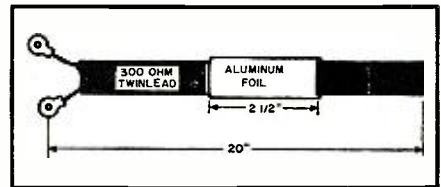

Fig. 6. Tuned line is used to locate interference frequency or act as trap.

then tuned in, and the foil moved up and down the line until a point is found at which the interference is at a minimum.

Diathermy interference is rare today, but, when present, is extremely annoying. The best cure for this condition is to locate the source and notify the Federal Communications Commission. For several years, it has been illegal for a diathermy machine to radiate and cause interference.

Most cases of insufficient signal in metropolitan areas are caused by blocking of the direct signal by a tall structure, such as an apartment house. In cases such as this, reception may often be obtained by means of a high-gain, sharply directional antenna, an example of which has been shown, oriented to receive a bounced signal from some large structure to the side or rear. When this means is ineffective, an attempt should be made to get permission to install the antenna on the roof of the structure that is blocking the signal. A third alternative is the use of a tower or telescopic mast, enabling the antenna to be even with or above the edge of the roof of the blocking structure. A 30-foot height will usually be more than sufficient.

Reception problems caused by the use of indoor antennas are difficult, if not impossible, to solve. Generally, the best cure is an outdoor roof installation.

A final difficulty occasionally observed is phase shift due to high voltage standing-wave ratio. The phase shift manifests itself as a ghost which will change position with variations in the fine tuning adjustment. This is almost always due to faulty installation techniques. Be sure the lead-in has minimal horizontal runs and does not run parallel to metallic objects closer than 6 inches. Often, the condition can be eliminated by removing several inches of lead-in from the slack left behind the set. This slack should also be kept as short as possible.

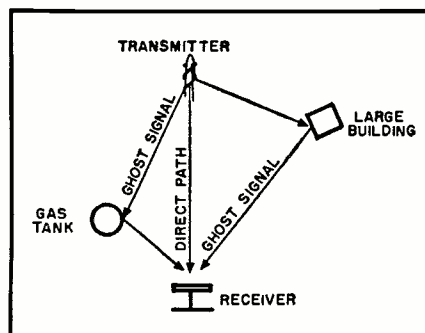
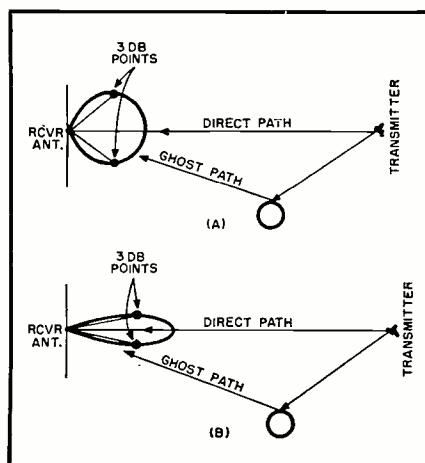
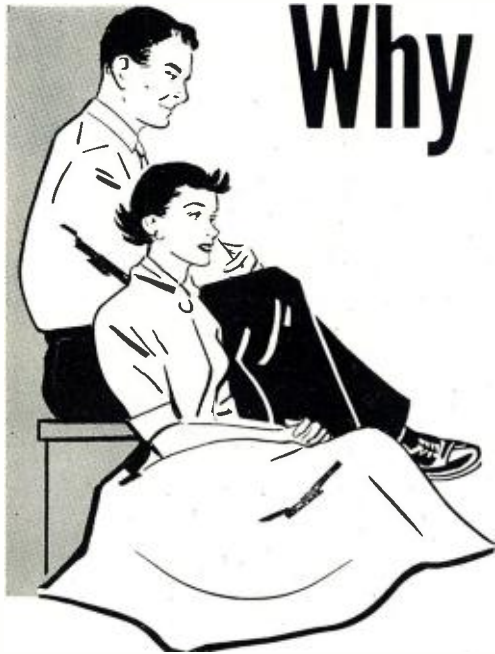

Fig. 3. The longer paths of the reflected signals are responsible for ghosts.

Fig. 4. A narrow-beamed, more directional antenna, like the one in (B), will reduce amplitude of the ghost.





Why Do

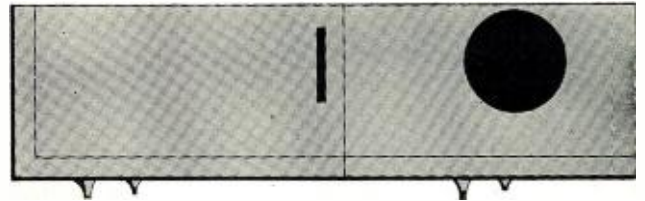

Amplifiers

Sound Different?

By **NORMAN H. CROWHURST**

Reasons for performance differences in audio power amplifiers having similar published specifications.

RECENTLY the opinion that the loudspeaker is the weakest link in the reproducing system and that amplifiers have progressed about as far toward perfection as it is possible to go has been widely expressed. As a basis for this conclusion, it is stated that the residual degree of various kinds of distortion present in modern amplifiers is so small as to be impossible to hear. However, many are not yet satisfied that this philosophy is true.

To illustrate this view, the following experience is by no means impossible or uncommon: two different amplifiers are compared, using the same pickup or tuner as a program source and the same loudspeaker. Both amplifiers, although of different design, use the same input and output impedances, provide the same damping factor for the loudspeaker, and give frequency responses and degrees of distortion which deviate by an acknowledged imperceptible amount—yet any discriminating listener can discern quite an appreciable difference between the sound of program played through the two amplifiers.

Why should these amplifiers sound different? A recent article on "Methods of Measuring and Specifying Audio Distortion" (August 1956 *RADIO & TELEVISION NEWS*) showed reasons why the same specified amount of distortion can sound different, according to the exact nature of the distortion, and pointed up the need for more precise methods of specifying such. This mostly related to the specification of distortion when clipping is involved.

But differences are noticed in the performance of amplifiers, even at

levels well below the clipping point. For example, a trumpet recording is played through the two amplifiers and on one sounds quite clean while on the other there is a definite harshness about the reproduction. When the gain control is turned back the harshness becomes less noticeable, but only because the level is that much lower—it does not disappear completely, as one would expect if it were due to clipping, or an overload effect.

It became quite evident that something happens inside some amplifiers that is not adequately covered by the specifications. Incidentally, the amplifiers were checked on the same measuring equipment and both found to conform to their published specifications, which ruled out the possibility that one was not as good as it claimed.

Experimental Confirmation

Some work the author has been doing recently has verified two possible contributing causes for this kind of difference. From the results of these experiments it seems quite possible for an amplifier to perform to extremely close limits under standard test measurements and yet, with program material, the same amplifier can produce temporary or transient distortion conditions that are loud enough to be perceptible. Both these transient conditions are related to the nature of the roll-off characteristic produced by the feedback.

It is well known that, when you apply more and more feedback to an amplifier, a condition is eventually reached where the amplifier becomes unstable. This is due to the fact that, at some frequency, usually below or

above the audio spectrum, the feedback becomes positive and causes oscillation. The frequency of this oscillation may be down in the region of 1 or 2 cycles or up in the region of 100 or 200 kilocycles, depending principally on which happens first.

Normally, of course, amplifiers are operated with considerably less than this amount of feedback, so they do not oscillate. Naturally, one would think that a margin of 2 to 1, or a little more, in this direction would be satisfactory to insure that the amplifier could not get unstable under any conditions. Many amplifiers have been designed with about this much margin.

This, however, overlooks certain fundamental facts that evolve from a mathematical consideration of feedback design. As this article is not written primarily for engineers, we shall refrain from going into the mathematics of such design. It is fairly easy to understand that, as we increase feedback, before the amplifier starts to oscillate, it will show a peak in the response, in the region of the frequency where it will eventually oscillate. The question is: how much must the feedback be reduced, below the amount which causes oscillation, before the peak is completely removed?

This is where the mathematics help some: in average amplifier design, we learn that the margin between oscillation and peaking, at the low-frequency end, is in the region of 18 db; while at the high-frequency end, it will be in the region of 12 to 14 db. These figures represent ratios of 8 to 1 and 4 or 5 to 1 respectively, both of which are considerably larger than the previously suggested margin of a little more than 2 to 1. These facts are illustrated in Fig. 1.

What Do Square-Wave Tests Show?

In comparatively recent times, the importance of an adequate margin at

the high-frequency end has been realized. This was shown up at first by the use of square-wave testing. If there is any peaking in the amplifier response, or if the roll-off is too sharp, this will show up on a square-wave test as ringing at the corners of the square wave, as shown in Fig. 3. Many amplifier designers have, accordingly, paid attention to this feature and made adjustments to the amplifier so as to prevent this ringing. This means that high-frequency peaking must be absent from the amplifier.

However, there may not be the full 12 to 14 db stability margin, because the designers have used a trick to produce a satisfactory square wave: phase-shift capacitors associated with the feedback circuit. It's true that this method produces perfect amplification of the high-frequency end, for transients as well as steady tone, *when the amplifier is connected to a resistance load.*

Sometimes the designer has been careful to make sure that the amplifier performs reasonably well into a reactive load, but to make this test he uses for his reactance a *capacitance* across the output.

What seems to have been overlooked is the fact that most people use dynamic loudspeakers (woofers, squawkers, and tweeters) whose impedance becomes that of an *inductance* at the high-frequency end—and an inductance that gives a reactance somewhat larger than the nominal voice-coil resistance. This means that the amplifier loading is quite different from the conditions under which it is tested, as shown in Fig. 2.

The nature of the "finagle" used can be seen by a glance at the schematic: it has at least a "phase correction" capacitor across the feedback resistor, and probably has several other small-value capacitors (values given in $\mu\text{fd.}$, not $\mu\text{fd.}$) at various points in the circuit. This produces a satisfactory response with less than the basic 12-14 db margin, but because of this the arrangement is inevitably more critical of the correct loading on the amplifier output. This means that the use of the inductive loading provided by the loudspeaker voice coil results in a transient response which is probably

worse than it would have been if the "finagle" had not been employed.

This fact accounts for the roughness in the high frequencies, observed with a number of amplifiers whose *measured* performance shows no trace of over-accentuation of the high frequencies, ringing on square waves, or distortion in this region.

Why the Struggle?

Perhaps a word is not out of place here, as to why this technique is employed. It arises principally from the current fashion for amplifiers to have a frequency response as near as possible from zero to infinity. Since zero to 20 cycles does not sound like a very big "piece," but 20 kilocycles to infinity sounds like an enormous range, the concentrated effort has been on the latter end. As a result, amplifiers have been produced with specified frequency response extending to 30, 50, 100, and even 200 kc.

While some of our high-fidelity cartoonists have suggested that such amplifiers are for the birds, this trend has generally been taken rather more seriously. Because of this, amplifier designers have been faced with the necessity of meeting specifications of this kind, dictated by the promotion or publicity departments of their companies. To get the amplifier to perform to these specifications, they have virtually had to resort to the kind of tricks we have mentioned, because the only alternative requires an output transformer whose price would be prohibitive.

What About the "Low" End?

So much for the high-frequency end. The low-frequency end seems to have escaped attention although, as we found, its effects can be disastrous with some kinds of program material.

Most amplifiers probably have a stability margin at the low-frequency end of at least 2 to 1, or 6 db, and probably as much as 12 db. But, to avoid any peaking effect at a subsonic frequency, they need a margin in the region of 18 db. Unfortunately this peak does not show up in the measured response, because it occurs in the *loop* gain characteristic and may not show up at the amplifier output, due to the

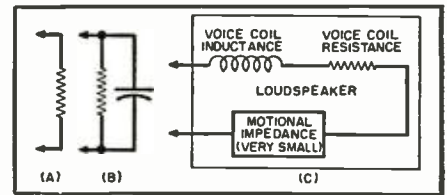

Fig. 2. (A) Common load used for testing although (B) is occasionally used. (C) Actual load offered by speaker to amplifier.

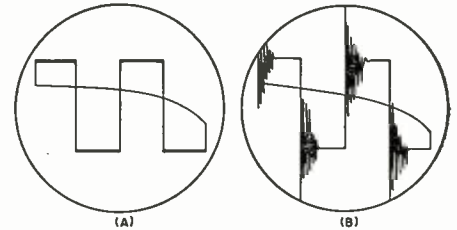

Fig. 3. (A) Good square wave applied to input and seen at output of very good amplifier. (B) A more common output waveform.

low efficiency of the output transformer at this frequency.

That is a rather technical distinction—just what does it mean to amplifier performance? A peak in the response anywhere means that any transient condition can cause the system to ring at this frequency. If the amplifier has any kind of peak in the region of 1 or 2 cycles, a transient condition can cause the amplifier to produce a kind of low-frequency flutter of this frequency, which may take a few seconds to die away. But what kind of transient would do this?

What Is a Low-Frequency Transient?

The frequency of ringing is down at one or two cycles, so the normal transient, with a sharp wavefront, will not necessarily cause this kind of ringing. The waveform that will produce it is one that possesses a momentary d.c. component. Many of these occur in practical program material.

For example, the trumpet waveform we mentioned earlier is quite asymmetrical; this means it is equivalent to an a.c. waveform, with a number of component frequencies, plus a d.c. component which offsets the waveform on one side of zero. This probably occurs due to the fact that the instrument is

(Continued on page 94)

Fig. 1. (A) Ideal response when the feedback is correct; part curves show instability points as feedback is increased. (B) Effects of various stability margins on the over-all response: 12 db is proper for high end and 18 db for low end.

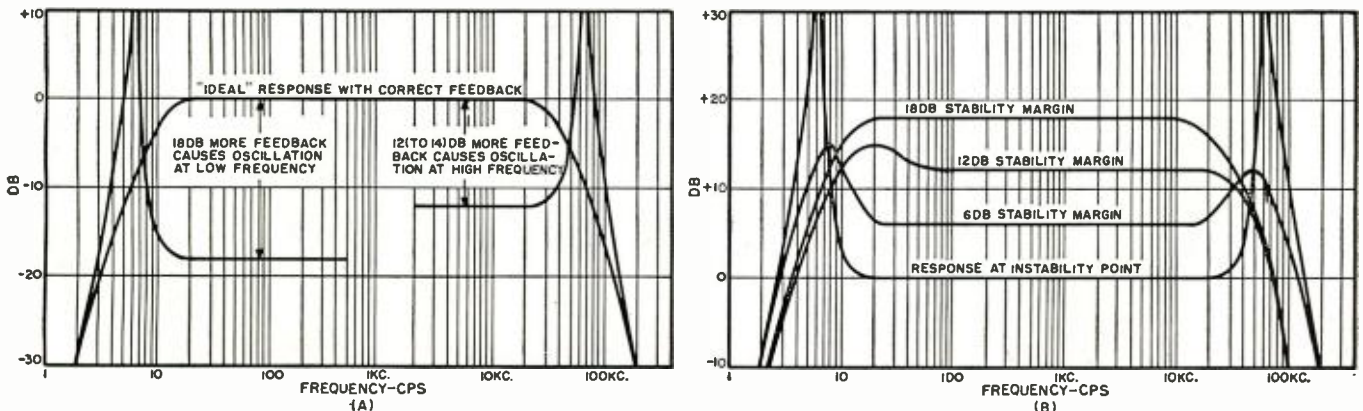

Are Your Electrolytics Leaky?

By
BEN CRISSES
and
DAVID GNESSIN

An easily set up quality test for the many unused filter capacitors gathering dust in most shops.

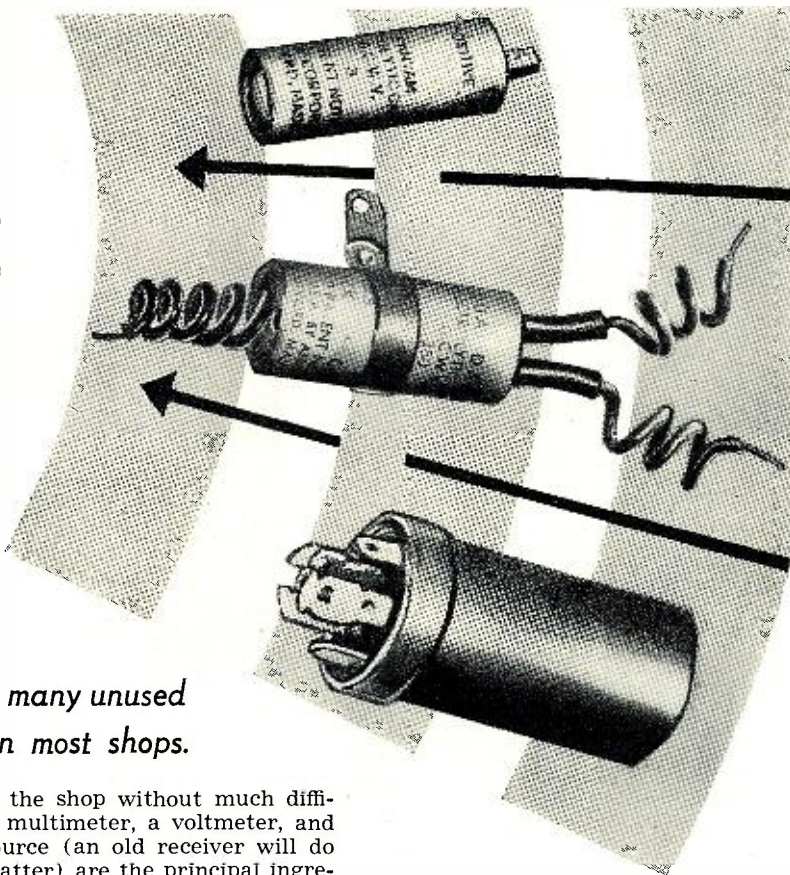

IT IS not unusual for a service technician to accumulate quantities of electrolytic capacitors of questionable quality. The collection occurs in this way: In routine servicing, he may decide that the quickest way to check electrolytics is to bridge a doubtful unit with a new one.

Even when results are indefinite, technicians will often wire the new unit in as a permanent replacement, as the proverbial "ounce of prevention." The old unit is laid aside without further examination, for time is important and customers are impatient. When business slows down, why not dig out these removed units and give them a qualitative check? It's easy.

Since excessive leakage is the characteristic that impairs the efficiency of electrolytics, a measure of leakage current is the best test. If this leakage current is within the tolerance recommended by the manufacturer, the capacitor may be considered good. In fact, the production test and the tolerances generally used may be dupli-

cated in the shop without much difficulty. A multimeter, a voltmeter, and a d.c. source (an old receiver will do for the latter) are the principal ingredients. In addition a 1-megohm potentiometer, a 10,000-ohm potentiometer, and a single-pole, single-throw switch are used. A fuse may also be added, as shown.

Fig. 1 shows the manner in which the meters, pots, switch, and d.c. source are connected, as well as the capacitor under test. Be sure, in this arrangement, that the capacitor is connected in the proper polarity, with its positive terminal going to the positive side of the voltage source.

Begin the test with the switch open, by adjusting R_1 so that the voltage being supplied for test purposes and being monitored by the voltmeter, is equal to the voltage rating of the capacitor. Then adjust R_2 to the position of maximum resistance; that is, so that its full 10,000 ohms is in series with the capacitor and the milliammeter. Now the switch is closed and resistor R_2 is moved toward its position of minimum resistance. This must be done *slowly* to avoid injury to the meter.

Observe the reading on the milliammeter while rotating R_2 , comparing it with the graph in Fig. 2. If the meter reading does not exceed the recommended maximum shown in this graph, the capacitor is within tolerance and has useful life ahead of it.

An example will serve to illustrate: Suppose you have a 40- μ fd. electrolytic rated at 450 volts. Hooking it up as shown in Fig. 1, R_1 is set to supply 450 volts. After R_2 is set to be fully in the circuit, S_1 is closed. Now slowly begin reducing the resistance of R_2 while observing the meter. If R_2 can be completely shorted out without

leakage current exceeding 19 milliamperes, the capacitor is still useful.

The ethics of impressing a used component into service as a replacement for a customer is something else again. There is no intention of encouraging the use of such parts instead of new ones. However, there are countless other applications around the shop where electrolytics in good condition, although they have already seen service, come in handy.

One precaution should be observed: if, while decreasing R_2 , the milliammeter reading should begin to rise above 35 milliamperes, open S_1 quickly. Leakage of this order indicates an extremely leaky capacitor, which could short out and damage the circuit. —50—

Fig. 1. Leakage current through capacitor is measured at rated voltage with the simple test circuit depicted here.

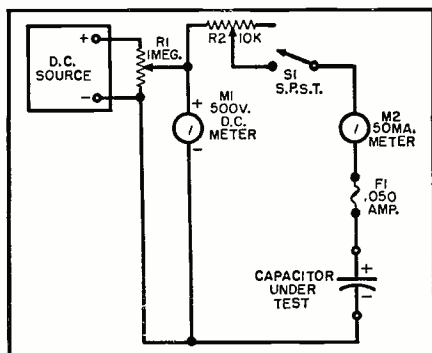
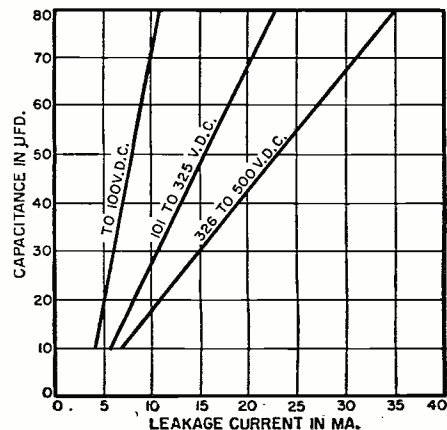
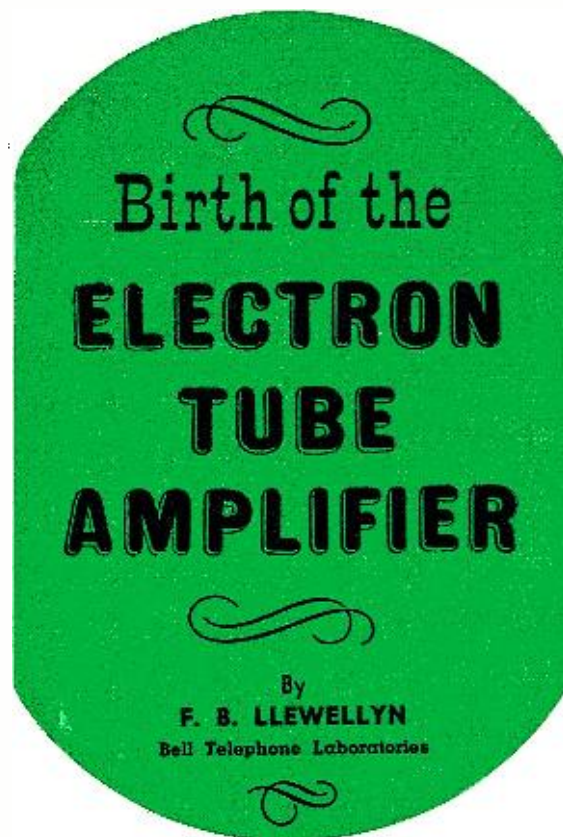

Fig. 2. Leakage for a given combination of capacitance and voltage rating should not exceed values shown here.





[[This picture of Lee deForest broadcasting through an arc transmitter was taken in 1907.]]



THE early history of the electron-tube amplifier has been beset with confusion. Much of this has been caused by failure to distinguish between the amplifier and the detector. The whole situation with regard to Fleming clears up when this distinction is kept in mind. The Fleming valve was instrumental in showing how the Edison effect could be developed to produce a practical rectifying device. It never amplified, though. It lacked the essential element, a third electrode, that would control the flow of electrons without absorbing power in doing so.

DeForest supplied the first step, *i.e.*, the addition of the third electrode. However, even he did not develop its amplifying properties until a good many years afterward.

The record of this three-electrode tube began on January 15, 1907, when the United States Patent Office issued to him a very significant patent. Its number was 841,387. It was entitled "Device for Amplifying Feeble Electrical Currents." This patent describes an electron tube. The output current is controlled by an electrode that does not itself draw appreciable current. This is the fundamental property of an amplifier. The patent illustrates this use. It shows the control electrode in the form of a plate located on the opposite side of the cathode from the anode. This arrangement is capable of amplifying, but not as well as when the control electrode is a grid

located between the cathode and the anode.

Another patent, deForest's No. 879,532, issued a year later, shows the control electrode in the form of a grid located between the cathode and the plate. (Fig. 1 of this patent.) This patent, however, describes the device only as a detector. The original amplifier patent, however, describes the amplifying action and shows two operable circuits. In one of them, Fig. 2 of the patent, the control electrode has a positive bias. In the other, Fig. 4, there is an unbypassed blocking capacitor in the external circuit of the control electrode. With gassy tubes, this arrangement would work better than with the modern high-vacuum tubes.

Many patents had been issued before these two. Even more have been issued since. It is fair to say, however, that few, if any, inventions have had as profound an influence on the American way of life.

Modern society depends on quick and direct communication. This, in turn, demands a "Device for Amplifying Feeble Electrical Currents." Such is the electron-tube amplifier devised by deForest. Today its uses are legion. It makes possible the nation's

long distance telephone system in its present form. Additionally, though, it is essential in radio broadcasting, in television, in radar, in control of airplane traffic, and in the large calculating machines and in guided missiles. These are but general headings. The diversified uses of amplifiers in each category illustrate anew the essential part that they play in the technology of these fields. Today the electronics industry measures its business in the billions, its personnel in the hundreds of thousands.

January 15, 1957, marked the Golden Anniversary of this important patent issued to Dr. deForest. He has received honors before. However, in this 50th Anniversary year of the electron-tube amplifier patent, it is especially fitting that we pay our respects to its inventor. DeForest started a chain reaction that had profound and far-reaching consequences. The first few links in the chain are especially worth re-examining at this time. Also, some of the surrounding circumstances seem not to have been made public before. In presenting this review, the object has been to concentrate attention on the development of the electron-tube *amplifier* and its circuits. By this approach, it is hoped

Contribution made by deForest is recounted for this 50th anniversary year of his original patent.

that the story will emerge free from the distractions that have involved it in the past.

New inventions of any technical complexity usually go through a period of growing pains. The electron-tube amplifier was no exception. In fact, there was a period of five long years after 1907 when almost nothing happened. One reason was that attention had turned to another property inherent in the electron tube used in the deForest amplifier. This was its ability to detect modulated radio waves. Although erratic, the early tubes formed more sensitive detectors for radio waves than anything that had preceded them. We now know that much of this improvement was attributable to their amplifying property. However, experimenters of 50 years ago did not know this. Over 800 electron tubes, capable of amplifying, were made and sold* by W. H. McCandless between 1907 and 1913. DeForest called them "audions." These tubes were of the type in which the grid was located *between* the cathode and the plate. Most of them were used by radio amateurs as detectors. A few, though, found their way into the experimental laboratories.

There is little record, however, of any having been used as amplifiers until 1912. On January 27 of that year, Fritz Lowenstein demonstrated a vacuum-tube device in a sealed box to F. B. Jewett and O. B. Blackwell, engineers of the *Bell Telephone System*. The equipment did amplify but

Photograph of the earliest type of three electrode audion tube, with the grid and plate leads brought out through the side walls of the cylindrical glass envelope. Filament leads are connected to screw base.

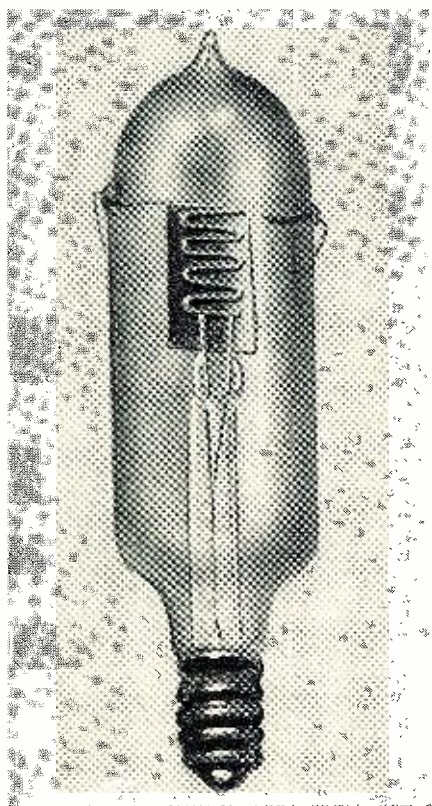

its action was erratic and uncertain. About a year passed, with correspondence back and forth, before Lowenstein disclosed the contents of a sealed box. This was probably the same sealed box that was demonstrated earlier. At any rate, the box, on its second appearance, was found to hold one of the deForest audions of the type made and sold by McCandless. It was in a circuit with the grid biased negatively with respect to the cathode of the tube.

In the meantime, Lee deForest and John Stone Stone had demonstrated the amplifying ability of the deForest tube to the engineers of the *Bell Telephone System*. The latter had had experience as a telephone engineer. He realized that an amplifier for electric currents would be an important adjunct to the telephone system. It would overcome the distance limitation on the transmission of conversations over telephone lines. The demonstration took place on October 30 and 31, 1912. This time there was no doubt about what the circuit contained. It was a deForest audion with the grid located between the cathode and anode. The circuit, however, was that of Fig. 4 in the deForest patent No. 841,387. As with the Lowenstein demonstration, however, the amplifying action, although undoubtedly present, was erratic and unreliable. Also, the absolute level of the output power was too low to be useful in telephone circuits of that time. In those circuits, the amplifier was called upon to deliver outputs that were much greater than would be needed to actuate a telephone receiver directly. This was necessary in order that the currents could still produce sounds audible above the noise in telephone receivers after having traveled a number of miles down an attenuating telephone line.

The telephone engineers were greatly interested nonetheless. They organized a project to study the circuit and tube and to determine whether its shortcomings could be overcome. The engineer directly in charge of this work was Dr. H. D. Arnold. He first saw the deForest tube and circuit in operation on November 1, 1912.

One of the things he noticed immediately was that the deForest tube developed a blue haze whenever the plate voltage supply was raised sufficiently. This indicated the presence of ionized gas. Moreover, Arnold calculated that the voltage would have to be raised in order to get enough output power from the amplified voice currents to operate in the telephone system. Thirdly, he concluded that ionization of the gas present was not needed in order to make the tube amplify; in fact, that the amount of amplification and the speech quality were better without it.

How to get increased speech output power without raising the plate volt-

age to the point where ionization took place? In modern television language, this was the \$64,000 question. Actually, the answer that Arnold found has been worth many, many times that amount.

Like many another great development, in retrospect the solution may seem simple. As of the time, November 1, 1912, it was anything but simple. What Arnold proposed was to pump the gas out of the tube. If there were no gas, obviously there could be no ionization. What could be more obvious?

But wait—two very grave obstructions stood in the way: the one mental, the other all too physical.

The mental obstruction stemmed from the fact that no one had supposed, before Arnold, that audions would be capable of amplifying at all without the presence of gas. Again and again we find evidence of this. The original patent of deForest calls for "an evacuated vessel inclosing a sensitive conducting gaseous medium maintained in a condition of molecular activity." Arnold had heard of the attempts of a German inventor, Robert von Lieben, to produce an amplifier tube. One of his structures used magnetic deflection of an electron beam without appreciable gas. It did not amplify, though. The deflecting coil absorbed too much power. Von Lieben then had turned to experiments with a gas tube. An amplifier structure had been proposed by Cooper Hewitt. This also required the presence of ionized gas. Too, the *Bell System* engineers had been speculating about the kind of apparatus that was in the closed box that Lowenstein had demonstrated almost a year earlier. The record shows some freehand sketches of a tube driven by a control electrode external to the enclosed portion. The shape of the glass structure was such that the presence of ionized gas would have been essential to its operation. Then, too, current theories of how electrons were emitted from hot cathodes required the presence of gas. Experiments had shown that pumping the gas out of tubes reduced the current when the gas pressure had become sufficiently low. Arnold wanted high currents, not low ones. To cap it all, Arnold himself was developing a gaseous amplifier!

It was no small mental step to pass over this mass of opinion and experience and say "Pump out the remaining gas."

Having said it, however, Arnold was face to face with the second obstruction: the physical one. It was easier to say "Pump out the gas" than to do it. True, within two weeks Arnold had succeeded in reducing the gas in one of the deForest samples by a substantial amount. He did this by heating the elements to provide a "getter" action. After that, he took a more decisive step. He ordered a new, and better, type of pump from Germany. By April 22, 1913, the new pump had arrived, been installed, and was in

* Records were made available by Mr. McCandless, first to Gerald F. J. Tyne, and then by Mr. Tyne to the present writer.

good running order. By October 18, 1913, the resulting tubes had been used to amplify telephone speech in repeaters installed in commercial circuits between Baltimore and New York. In July, 1914, transcontinental conversations were going through amplifying repeaters. They have been doing so ever since the official opening to the public in January, 1915.

It would be difficult to find another momentous technical development that, once started on the right track, moved with the speed and directness of this one. Less than a year elapsed from the time Arnold first saw the deForest audion with its imperfect vacuum, on November 1, 1912, until the vacuum-tube amplifier had been used on commercial telephone lines!

The high-vacuum concept and the development of high-vacuum tubes were not the only contributions that Arnold made to the electron-tube amplifier. He also had the foresight, or genius, to see that the grid blocking capacitor that deForest used was a hindrance. He got rid of it!

Again, in retrospect, this seems to be a simple thing to do. However, at the time it was not simple. Among all the conceivable things that might be causing the deForest circuit to balk and distort when large signals were applied, who but a genius would realize within a matter of less than three weeks where the source of trouble lay? On November 16, 1912, there appears a circuit diagram in the laboratory notebook of Arnold's assistant, Mr. P. H. Pierce. It shows the blocking capacitor. It also shows a strap drawn around it and the notation "short circuit." On November 26, 1912, Research Engineer E. H. Colpitts wrote to Assistant Chief Engineer F. B. Jewett as follows:

"Two methods of using a valve having three elements, namely, a heated source of electrons or a heated filament, a plate and a grid in an evacuated chamber, as, for instance, in the audion, have been employed with the result that we have been able to overcome the more serious defects in the behavior of the deForest audion used as apparently proposed by him. . . .

"In the sketch above, first method, a high resistance is bridged between the plate and the grid, as shown. In the second method shown above the capacitor in series with the grid is omitted. In addition to this it is also possible to introduce an electromotive force in series in such a way as to largely prevent direct current from flowing in that circuit. . . . Of the two arrangements shown above, the second one, with the capacitor in the grid circuit omitted, seems to be substantially more efficient."

Thus was born the electron-tube amplifier. It took the genius of deForest to insert the third element, the grid, in the tube. It took his genius to

see that, in this form, it could be used as a "Device for Amplifying Feeble Electrical Currents." In addition, though, it took the genius of Arnold to grasp the situation, practically at a glance, and come to an understanding of the causes of the limited output power and erratic behavior of the gassy tube with its circuit containing an unbypassed grid blocking capacitor that was demonstrated by deForest and Stone Stone.

It is interesting to note that the two steps taken by Arnold were both in the direction of getting rid of something that was causing trouble. We usually think of a development as a putting-together. To improve a device, you add something to it. In the vacuum-tube amplifier, Arnold did the opposite. He took something away: first the gas and then the grid blocking capacitor. This is why his work had the stature of genius. He had the boldness to take a course that was different from the conventional; but he understood what he was doing and foresaw that it would bring him to the desired goal. Through his keen scientific insight, the momentous invention that deForest had made was brought to a state where its inherent possibilities could be utilized.

The whole episode illustrates, also, the fortuitous interplay of objectives and situations that were present during the invention and development of the electron-tube amplifier. In his earlier work, deForest wanted a detector for radio waves. So did most of the other workers with vacuum-tube devices. They thought in terms of a modulated high-frequency incoming signal. They were trying to recover the envelope. For this purpose, the severely non-linear properties of gassy tubes were desirable. Their erratic behavior was to be put up with in order to obtain their advantages. For an amplifier, on the other hand, the nonlinearity was a drawback. The gas offered nothing useful. But it was hard to see this when one had been thinking of detectors almost exclusively.

In the gas tubes of the day, the electrodes could be placed quite far apart. In fact, many of the tubes

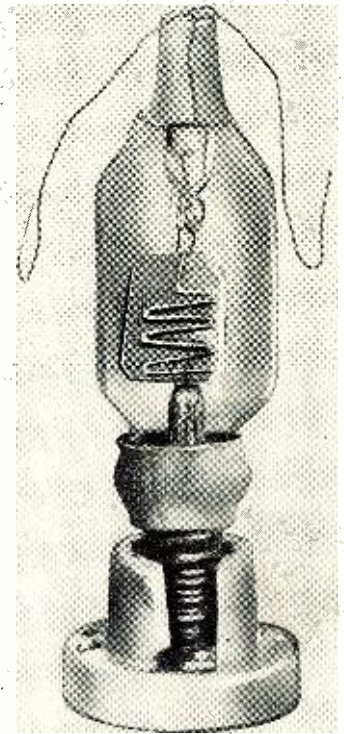

Early deForest audion. This picture came from the late Sir Ambrose Fleming together with a label in his handwriting worded "deForest original valve or Audion. 1907." The over-all height of the tube, including the screw base, is about 3¾ inches.

worked better that way. Too, the glass bulb could have protuberances to accommodate the electrodes. Consequently, the compact structure of the deForest "audion" was a step in a direction away from the conventional thinking.

And, finally, the part played by John Stone Stone should be remembered. He it was who acted as catalyst. He brought together deForest, who had a "Device for Amplifying Feeble Electrical Currents," and the telephone engineers who had need for an amplifier. Through this contact, Arnold was enabled to develop the device into a reliable and flexible component. With it the development of the telephone system into its present form was made possible.

-30-

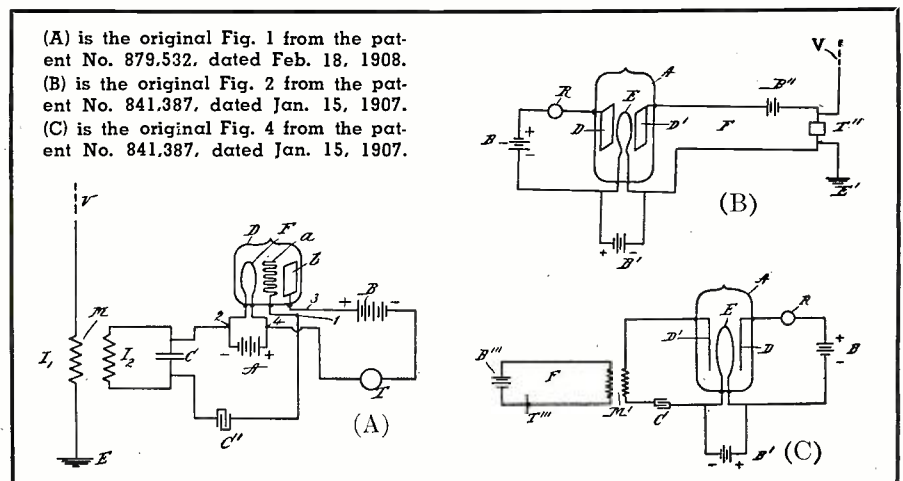

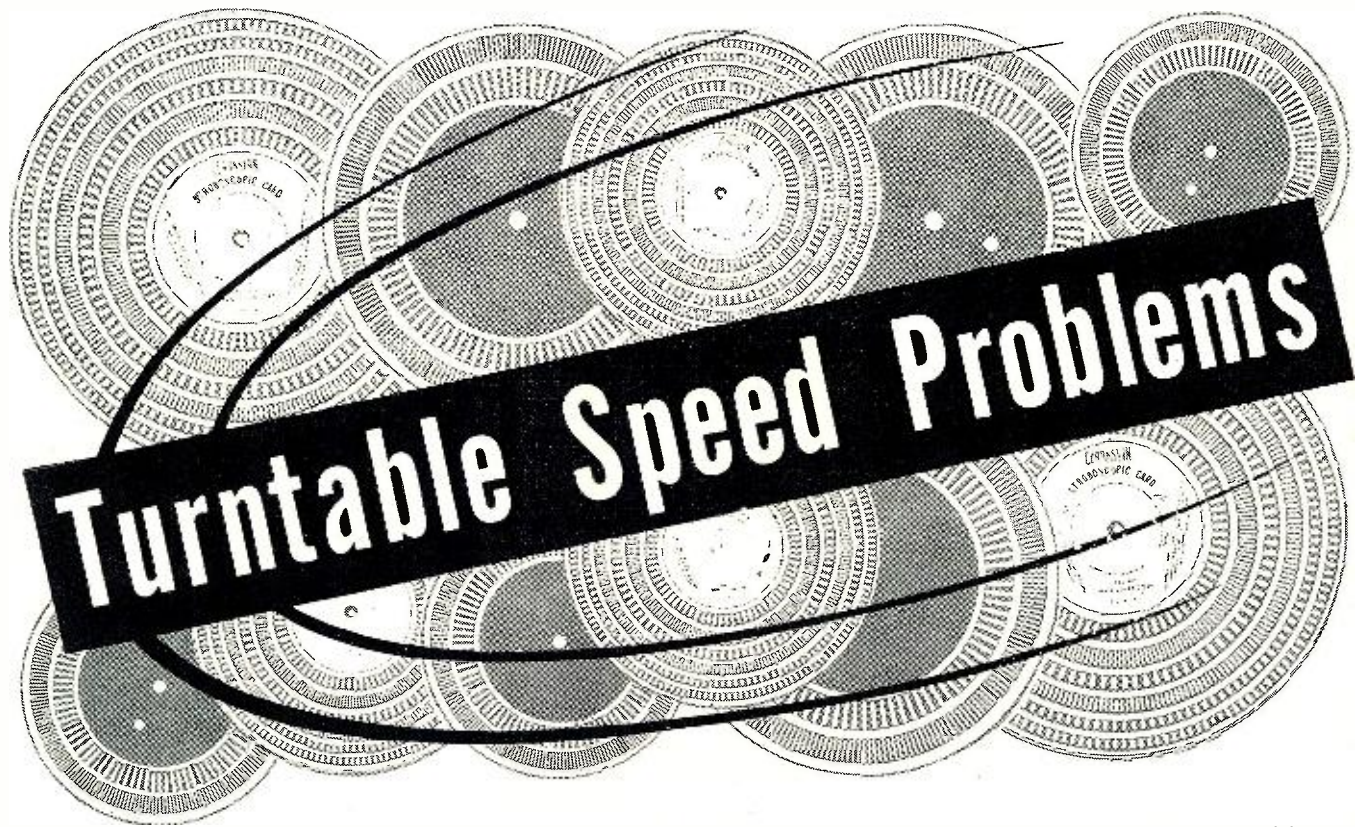

By CHARLES GARRETT

Remedial measures to counteract slippage, wear, and motor defects. Stroboscopic speed checks.

IRREGULAR turntable speeds, turntable stalling, and too slow or too fast a speed have one or more of the following four causes:

1. *Slippage* between the turntable rim and the drive wheel or between the drive wheel and the motor shaft.
2. *Wear* in the rubber drives and three-speed mechanism.
3. *Defective motor* with either a bearing loose and out of line or a defective winding.
4. Motor shaft or motor sleeve of improper sizes.

Of these four defects, slippage somewhere between the motor shaft and the turntable rim is the most common and also the easiest to correct. This trouble generally centers in the large rubber-tired drive wheel. (See Fig. 1.) After long usage this drive wheel either wears down or the rubber loses some of its resiliency thus preventing it from firmly gripping the turntable rim or the motor shaft.

In a few cases the drive wheel is not able to turn freely on its shaft. The application of oil—in the right places only!—or the sandpapering of the drive wheel shaft should correct this particular problem.

But slippage requires a different approach. The usual symptoms of slippage are turntable stalling; slow starting, especially under the weight of two or three records; and irregular, jerky table rotation. A turntable with slippage, for one thing, can easily be

stalled by placing your fingertips on its edge.

First inspect the large rubber-tired drive wheel; if it shows signs of wear, replace it. Replace it especially if it has developed a flat indentation on any part of its surface. Then clean the inside rim of the turntable with carbon tet to remove any dirt or film. Also check the tension of the spring that pulls the drive wheel to the rim. Replace it if it is weak or stretched.

If some slippage still remains, try the following method for a sure and lasting correction. Dissolve a few small pieces of rosin dial-cord dressing in a small bottle of *General Cement* service solvent, or similar fluid. Use plenty of solvent to keep the solution thin and watery.

Then with the turntable removed, the motor on and turning, and engaging the drive wheel, apply a few drops of this solution to the junction of the motor shaft and drive wheel. In addition, on three-speed tables, apply the solution to all three of the motor drives and to any rubber drive belts. Engage each speed and keep the motor running until the surfaces dry. The rosin solution can also be applied to the inside rim of the turntable for additional gripping power.

Re-install the table and allow it to run. If too much solution has been applied or if it was too thick, the table may squeak for a few minutes. If it persists, apply a few drops of clear

solvent to the drives to rinse off the excess rosin.

The rosin solution may be applied without removing the turntable if the bottom of the table can be reached through the underside of the changer. Simply apply a few drops of the rosin solution to the underside of the turntable, holding the record player vertical. The solution will run to the rim and will eventually coat all the drives. This approach is desirable on those changers whose turntables are difficult to remove—like certain 45 r.p.m. players, for example.

Motor Repair

Poor speed regulation, very slow speeds, wow, as well as a stalled motor often are due to a defective motor winding or to a loose, off-center motor bearing. A motor that rapidly overheats so as to be too hot to touch most likely has a shorted winding. A good motor, even when intentionally stalled, will not overheat excessively for at least four or five minutes. A motor with a defective winding has to be replaced. An off-center motor bearing is, however, generally repairable with a good degree of success. One type, mounted in a stamped brass housing, seldom gives trouble.

Another type of motor bearing, however, is more likely to need repairing from time to time. A bearing of this type consists of a stubby brass sleeve and it is seated in a large grey-metal housing. These bearings may be located with reference to the armature of the motor. One will be found above the armature; the other will be found below it. The bearing is held

in place in the cast housing by means of a retainer that looks very much like a metal washer. This one-inch retainer, in turn, is held in place by four metal nibs. The arrangement is shown in Fig. 2.

Trouble develops when this retainer slips out from under one or more of the nibs, thus giving the brass bearing room to shift from side to side.

Correction of this consists first of removing the bearing housing from the motor by removing the two bolts that extend through the motor; next re-centering and re-seating the brass sleeve or bearing by hand; and then driving the retainer back under the nibs with a screwdriver and a light hammer. The nibs, which are only indentations pressed out from the side of the cast assembly, should be enlarged with the same screwdriver and hammer to prevent future trouble.

Apply a light oil generously to the bearing before re-installing the assembly. Do not overtighten the motor bolts. Keep the tension equal. Overtightening of either bolt can throw the bearing assembly as a whole out of line.

Inherent Speed Defects

The more difficult turntable speed defects to solve are those that are inherent; that is, are due to improper sizes in the motor shaft and/or motor drives. Record players with this type of defect will consistently run either too fast or too slow on one or all speeds.

This complaint is not uncommon in inexpensive three-speed units where manufacturers' tolerances are apt to be less rigid than with studio equipment. Occasionally, on higher priced units, one speed may be slow due to wear on one of the three-speed drives, but seldom is the motor shaft or shaft sleeve off-size.

If this is so—if there is only one record speed with improper rotational speed (r.p.m.)—look for a worn intermediate drive wheel. These are the ones between the motor shaft and the large rubber-tired drive wheel (see Fig. 1). Replacement of the defective part is the answer here.

But, on the other hand, if all three or four speeds run too fast or too slow (assuming that no slippage exists and the motor is not defective), the motor shaft or motor sleeve is off-size. Being *oversize* results in too *high* a turntable r.p.m.; being *undersize* results in too *low* an r.p.m.

Incidentally the large rubber-tired drive wheel has nothing whatsoever to do with normal turntable speed. It is merely a method of coupling the motor shaft or separate speed drives to the rim of the turntable. And the speed drives are basically enlargements and reductions of the size of the motor shaft.

Turntable r.p.m. is determined by the diameter of the motor shaft and motor drives, and the r.p.m. of the motor. Therefore, in any attempt to correct inherent speed defects, ignore the large drive wheel.

Many motor shafts have a sleeve on the section that contacts the drive wheels. This sleeve is similar to a section of heavy dial-cable spring. If the speeds are too fast, the diameter of this sleeve has to be reduced. On solid one-piece shafts, the shaft itself must be reduced. A fast and efficient way to accomplish this is as follows:

Remove the turntable, all drive wheels, large and small, that are in contact with the motor shaft, and any drive belts. Run the motor and hold a small, fine-grooved metal file (Fig. 3) flat against the side of the revolving motor shaft. This action turns down the shaft or sleeve in an even, level manner.

File lightly, and recheck for speed correction after even a very small amount is filed off the shaft or sleeve. The motor drives and turntable will, of course, need re-installing in order to check for correction in the table's r.p.m.

A few three-speed record players use a motor shaft sleeve that has three different diameters turned down on it (see Fig. 1B). On these, file down only the section that corresponds to the turntable speed needing correction. Some of these three-speed sleeves are mounted separately, beside the motor shaft, and are individually replaceable. It is always best to replace a defective part when possible, rather than to file it down.

Yet another approach is required to correct too low an r.p.m. condition, for this means that the motor shaft is too small and needs enlarging. It can be enlarged with surprisingly lasting results by adding a film of solder to its surface. The process is relatively simple and can be accomplished on all types of motor shafts and sleeves, including the three-speed motor sleeves.

First sandpaper the sides of the motor shaft or sleeve until clean and bright. Remove all rubber drives and drive belts that would be injured by heat. Coat the area to be soldered with an acid-base soldering paste.

Then with the motor off and the shaft held in a horizontal position, heat and apply solder generously and as

(Continued on page 98)

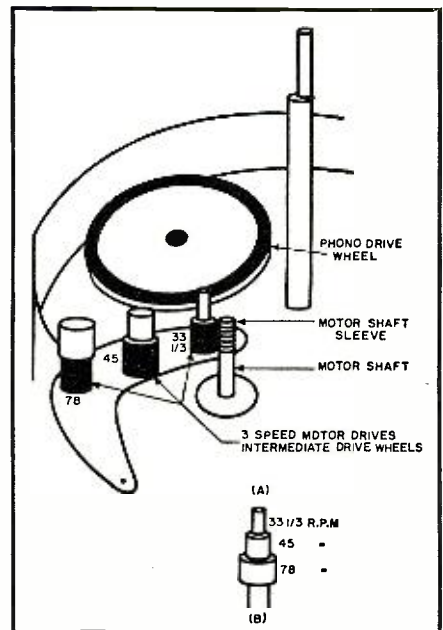

Fig. 1. Motion of motor, through its shaft, is transmitted to speed-changing drive wheel, to rubber drive wheel, to inner rim of turntable. Three separate intermediate drives for the various speeds are shown in (A). Sometimes a single shaft with three stepped diameters is used for speed changes, as in (B).

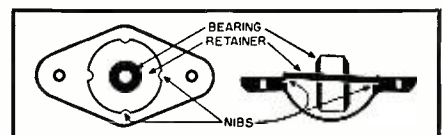

Fig. 2. Motor bearing may be unseated.

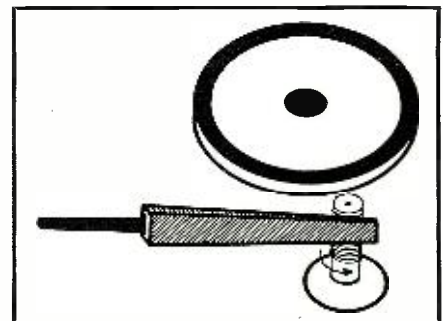

Fig. 3. Filing down the motor shaft.

Fig. 4. A neon flasher unit for stroboscopic speed checks (left) may be built simply. It is used with a stroboscopic test card, as in the right-hand photo.



Certified RECORD REVUE

By BERT WHYTE

FOR some time now I have made a habit of reading the ads about the so-called "hi-fi" radio-phonographs, that are appearing with increasing frequency in the pages of our daily newspapers. As I have pointed out before the claims made for this "phoney-fi" are simply incredible in their brash exaggeration. They have lifted most of the more popular and well-known terms in the hi-fi lexicon and have either misapplied them or perverted the true meanings with the result that a great many people are walking around spouting terms about which they haven't the foggiest understanding. Every now and then, some of these people find their way into a legitimate hi-fi salon and the poor salesman must contend with these "experts." The salesman must expunge the wrong ideas they have acquired and then laboriously re-educate them in the true and basic concepts of high fidelity.

One of the pet questions the misinformed have been asking concerns *four* speed record players . . . yes friends they mean, "the kind that plays 78, 45, 33 $\frac{1}{3}$, and 16 rpm records." Some sharp-eyed readers may have noted that, in these newspaper ads, considerable stress is placed on the fact that their players can handle the fourth or 16 rpm speed. And habitués of sound rooms may have also noted that without any fanfare, new models of the better high-fidelity changers have appeared with facilities for playing 16 rpm records.

Now as most informed readers of this column are well aware, the only 16 rpm records now in use are the highly specialized type produced by *Columbia* for the so-called "Highway Hi-Fi" players found in *Chrysler Corp.* cars, and the splendid "talking book" records for the blind produced by the *Light-house for the Blind* in New York. So why this emphasis on 16 rpm in the commercial set-makers? And why are the manufacturers of the high-quality component-market changers offering the fourth speed? Are they all using it as a sales gimmick? Is there a more practical reason?

I decided to snoop around the back alleys of the industry and see if I could come up with an answer. I found out far more than I had bargained for and, indeed, some of the information is quite astonishing. In spite of protestations from all sides that no one was contemplating the issuance of 16 rpm records, quite a few companies seemed to be spending an inordinate amount of time on 16 rpm research. My own personal feeling is that no 16 rpm are actually scheduled for release in the near future but each company is keeping a wary eye on the other and wants to be ready with a product in case anyone should jump the gun. I think the 16 rpm discs are being held as an ace in the hole, a sort of hedge against the possibility of a depression in the present record market. You can be fairly sure that with the prosperity the record business is now enjoying it would be

most imprudent of any company to introduce the new speed and risk upsetting the economic apperant. As for the problems of the 16 rpm record there are many . . . high-frequency response has been difficult to achieve . . . stylus velocities have been restricted and dynamic range limited . . . and the problems of reproducing the records pose some real toughies.

In fact, the joke of this matter is that the "phoney-fi" machines which are touting their fourth speed, have record playing mechanisms least likely to be successful in handling these 16 rpm discs. Because of the very slow speed, the problems of wow and flutter will be magnified immensely. And the rumble will really be king-sized . . . it's bad enough in the commercial sets at 33 $\frac{1}{3}$, let alone the slower speed! The component type hi-fi changers will probably handle the 16 rpm material with a minimum of difficulties, but my feeling is that the new speed was added more as a precaution . . . to guard against obsolescence "just in case" the 16 rpm record should actually appear on the market.

In spite of all the problems of the 16 rpm record, it is only fair to report that considerable progress has been made by disc companies in solving them. Purportedly one company has made 16 rpm discs whose quality is equal to today's LP record. I have not heard them myself, but lending weight to this report is a rumor that England's great *EMI* record combine has not only perfected a 16 rpm recording, but it has found the answer to the stereophonic disc problem which they have been working for the past few years. If one can believe this fantastic report, two styli of very small radii are used, one of the styli picking up recorded modulations on one *side* of the groove and the other styli picking up what amounts to the second channel from the other *side* of the groove. I suppose if the land between the grooves could be made small enough and the special cartridge and styli are employed it might work. Presumably, the 16 rpm speed was chosen so that it would give an adequate amount of time on one side of the discs. This is, of course, a different approach than the high-frequency carrier technique for obtaining the second channel, I reported on recently, and it is known that the British were working on this principle; thus one might assume that this proved unfeasible and was abandoned in favor of this new technique.

Another fairly well-founded report in this country is that one of the major juke box manufacturers is definitely investigating the 16 rpm speed for use in background music applications. True or not, all these reports are certainly tangible evidence that somethin' is astir in the laboratories of the record com-

The opinions expressed in this column are those of the reviewer and do not necessarily reflect the views or opinions of the editors or the publishers of this magazine.

panies that bears close watching. For the beleaguered hi-fi salesman I can offer this advice . . . if someone badgers you about the 16 rpm speed, you can tell them quite truthfully that as matters stand at present, the extra speed is strictly a sales pitch—that 16 rpm records are a possibility only for the dim and distant future, and that if they ever do reach the market their successful reproduction will be possible through high-quality, hi-fi changers and turntables, but a very dubious proposition with the run-of-the-mill packaged radio-phonographs advertised as "hi-fi" in our daily press.

This is all there is to the story at the present writing but should anything break in the near future, rest assured that I will report a "blow-by-blow" account of the event so that you will be *au courant* of any development that may ultimately affect your record library or pocketbook.

The record season is in full swing now and it is nice to be able to report that although the quantity of recordings is greater than ever, the percentage of quality discs is gratifyingly high. There is so much good music to tell you about the reviews will have to be on the abbreviated side.

**VAUGHN WILLIAMS
SYMPHONY #8 IN D MINOR
BUTTERWORTH
A SHROPSHIRE LAD
BAX**

**THE GARDEN OF FAND
Halle Orchestra conducted by Sir John Barbirolli. Mercury MG50115. RIAA curve. Price \$3.98.**

No, you're not seeing things! It is indeed Sir John and his Halle Orchestra on a *Mercury* "Olympian" recording. This orchestra is *Mercury's* latest acquisition and a foretaste of other surprises to come. The Halle Orchestra is one of England's best and well-known and its conductor, Barbirolli, is quite familiar to concert-goers in this country having guest-conducted extensively and was conductor of the New York Philharmonic in 1936.

It is typical of *Mercury* that they did not entrust the engineering aspects of their first recording of the Halle Orchestra to a foreign group. Instead they went to the considerable expense and trouble of sending their famous recording truck to England, where after much experimentation they adapted their well-known single-*Telefunken*-mike pickup to local conditions. As a listen to this disc will bear out, their efforts were well worth while.

As a fitting vehicle for the Halle Orchestra *Mercury* debut, we have the world premiere recording of the "8th Symphony" by England's great octogenarian composer, Ralph Vaughn Williams. This incredible 85-year-old, continues to astound musicologists with the power and vigor of his writing and his contrasting musical thought as he progresses from each preceding symphony. This 8th symphony is almost jocular when compared to the bleak mysterious attitude of the 7th, the "Antarctica." It is hard to categorize the nature of this work. The first movement is an unusual free-form fantasia on seven variations, the scherzo is for wind instruments alone, the third a cavatina for strings alone, and the fourth a savage toccata which employs a greatly augmented percussion battery. A rather strange work from the pen of Vaughn Williams and one cannot help but feel that the over-all flavor is one of wry and sardonic humor, with the composer "twitting" us just a bit. The work is dedicated to Barbirolli who obviously relishes the score from the manner in which he conducts. Under his devoted baton, the Halle group delivers itself of some magnificent playing. There is a warm, romantic tone, not as sumptuous as the Philadelphia or Vienna

(Continued on page 102)

RADIO & TELEVISION NEWS

The Consonant Amplifier-Limiter

By DONALD B. DANIEL, W5KYO/6

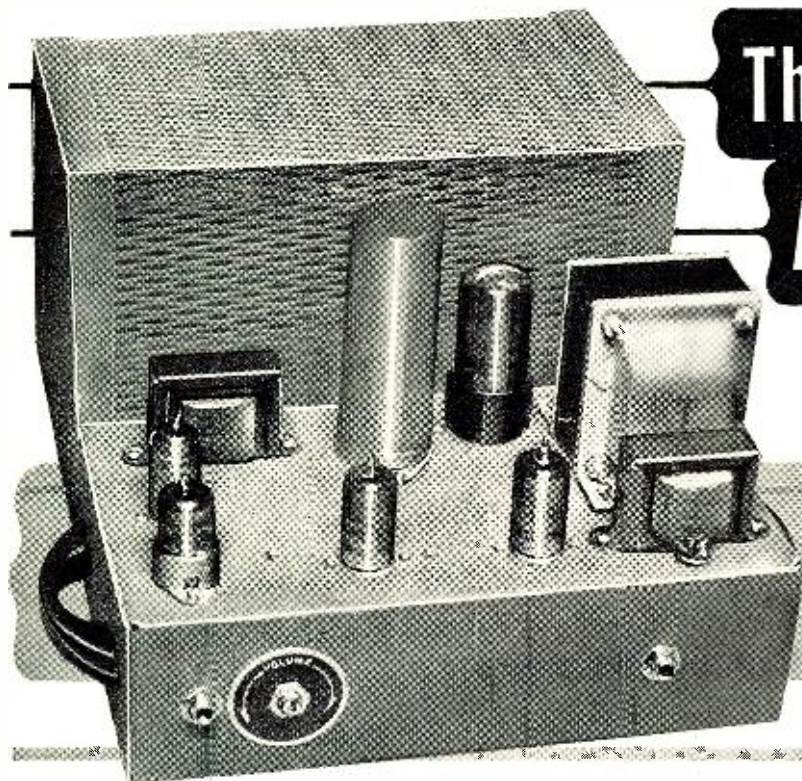

Fig. 1. Over-all view of consonant amplifier-limiter ("CA" limiter) is shown.

SINCE the early days of voice communication by radio, efforts have been made to compress the dynamic range of the human voice to make it more compatible with the electrical characteristics of the communications system. Benefits to be derived from such a procedure are many, and quite often well worth the expense of the compressor equipment that is added.

To prevent confusion as to what type of compression is under consideration, it might be well to define several types of common compressors in terms of their characteristics and merits.

Definitions of Terms

A "compressor" is an automatic variable gain amplifier whose output bears some consistent relation to its input, say one db rise in output for each two db rise in input. Usually this type of equipment will have very low steady state distortion. Most common compressors use some type of a feedback loop that samples the output of the amplifier and regulates the gain of an earlier stage. The time-constants of this type of circuit are necessarily slow to prevent oscillation, motorboating, and distortion. The "attack time" (time necessary to reach steady state condition after a sudden rise in input level) may well be several milliseconds. The "release time" (time necessary to reach a steady state condition after a sudden drop in input level) may be several seconds. Such an amplifier is very useful for high-fidelity recording and broadcast radio where

New approach to audio limiting features extremely fast attack and release times without the distortion common in clipper circuits. Useful in transmitters and receivers.

an operator is in constant attendance. Compression of about 10 db is usually considered as an acceptable maximum value.

A "limiter" is an automatic variable gain amplifier whose output level is controlled only after a threshold level has been reached. Here, again, it is quite common to use a feedback content loop to regulate the gain of an early stage. Time-constants are usually slow, like the compressor, and limiting of more than 15 db is usually not recommended.

A "clipper" is a circuit that is designed to prevent the amplitude of a signal from exceeding a preset level. Its time-constants are practically instantaneous and it functions on each cycle of a wave. Distortion is very high, which results in loss of individuality in speakers and a broadening of the spectrum occupied by the speech. Low-pass filters are usually used in conjunction with clippers to limit the spectrum and reduce distortion. Clipping of more than 15 db is considered objectionable by many. Nevertheless, clipping has been very useful because of its simplicity and ability to prevent overmodulation when employed in radio transmitters.

The ability of a clipper to prevent

overmodulation results from its extremely fast attack on a wave after it exceeds the threshold. A good clipper has no overshoot. A clipper also has extremely fast release. A weak signal following one cycle after a wave that is heavily clipped will not be limited. This means that a weak consonant that follows a loud vowel in human speech will be given full amplification, although the preceding vowel was severely clipped. This amplifying of weak sounds in relation to soft sounds is often referred to as "consonant amplification," which may be abbreviated for convenience and simplicity as "CA."

Response Speed

"Consonant amplification" is an asset in communications equipment which must overcome channel noise, but it would not please a hi-fi enthusiast. Clipping is an excellent way to produce consonant amplification, but the increase in distortion with increased clipping places a practical limit on the extent to which this process can be carried on in actual equipment.

At this point it may be of interest to consider just how fast an amplifier must operate to be satisfactory as a

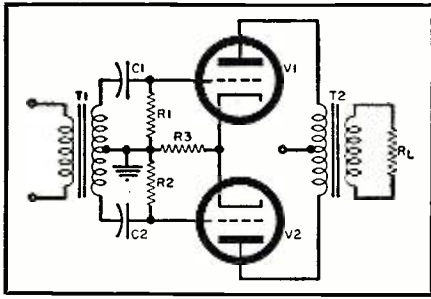

Fig. 2. Simplified schematic diagram of basic push-pull grid bias limiter circuit. Note the use of capacitors to isolate the tube grids from the input transformer. Variable mu triode tubes are employed in actual circuit.

consonant amplifier. Human speech does not usually start abruptly, nevertheless, there are audible sounds that occasionally have steep wavefronts. Therefore, it is probably desirable to have an attack that will function on the first half cycle of any audio tone that is expected to be present. Assuming a maximum audio frequency of 5000 cps, this would require an attack of one ten-thousandth of a second or 100 microseconds. An attack of this speed will insure that there is no overshoot and its resultant over-modulation in ordinary transmitter usage.

To arrive at the slowest release speed at which satisfactory consonant amplification is accomplished is very difficult because of the great variance of speed of speech between speakers. It is probably a good idea to make the release as fast as possible, and in any case faster than 200 milliseconds, which is the nominal speed at which the human ear can detect sudden changes in amplitude.¹

The "C A" limiter pictured in Fig. 1 accomplishes the dual objectives of an extremely fast attack and a very fast release without the excessive distortion of a clipper circuit through a new approach to audio limiting. Possibly this is best described as push-pull grid bias limiting.

Fig. 2 is a simplified schematic of

the basic push-pull grid bias limiter circuit. It can be spotted as a typical push-pull amplifier with transformer input and output. It differs from a typical amplifier in two respects. First, the tube grids are isolated from the input transformer by capacitors C_1 and C_2 . Second, V_1 and V_2 are variable μ triodes.

Principles of Operation

The push-pull grid bias limiter operates as follows: The input signal e_{in} is coupled by transformer T_1 , through capacitors C_1 and C_2 , to the grids of V_1 and V_2 . Tubes V_1 and V_2 are cathode biased by resistor R_3 . If the input signal is less than the bias voltage the circuit performs as a linear amplifier. When the input signal exceeds the cathode bias the grids draw current in quite the same manner as any class B power amplifier. The grid current charges C_1 and C_2 , thus creating an additional grid bias. This additional grid bias reduces the μ of V_1 and V_2 and thus reduces the gain of the amplifier. The greater the input signal, the lower the amplifier gain. Distortion produced by the non-linear operation characteristics of the variable μ tubes is predominantly even-order harmonic and is, therefore, phase cancelled in the audio output transformer T_2 .

There is a practical limit to the amount of variable gain that can be accomplished in the simple push-pull grid bias limiter without exceeding a maximum distortion of 10%. With the tubes now available this seems to be about 10 db. Fortunately, it is possible to cascade several stages to obtain any desired amount of limiting. Two stages of resistance-coupled push-pull grid bias limiting were used in the amplifier pictured in Fig. 1 to accomplish 20 db limiting with less than 10% distortion. See Fig. 3.

Referring again to Fig. 2, consideration of the factors that control attack and release time will indicate the possibilities of this circuit. Typical values for C_1 and C_2 are 0.01 μ fd. Typical values for R_1 and R_2 are 2.2 megohms. A

typical output impedance for transformer T_1 could be 15,000 ohms. The grid conductivity of tubes V_1 and V_2 will be only a few hundred ohms at most and can be disregarded. The time-constant for the charging of C_1 or C_2 is $15,000 \times 0.01 \times 10^{-6}$ or 150 microseconds. When the input signal suddenly drops in level, capacitors C_1 and C_2 will start to discharge through their respective resistors R_1 and R_2 . The discharge time constant is $2.2 \times 10^9 \times 0.01 \times 10^{-6}$ second, or 22 milliseconds.

Complete Circuit

Fig. 4 is the complete schematic of the "C A" limiter. A 12AX7 is utilized as a two-stage preamplifier for the 6C4 driver stage. There is sufficient gain and drive power to drive the two-stage push-pull grid bias limiter from a crystal or high impedance dynamic microphone. Noise level is an important factor in the preamplifier. If it is planned to utilize 20 db of limiting at maximum output, the preamplifier must have 20 db lower noise level than normal. For communications or recording purposes, a noise level of -40 db is usually acceptable. This necessitates a -60 db noise level in the preamplifier. This is accomplished by a well filtered d.c. supply and by placing the input tube and mike jack diagonally across the chassis from the power transformer. Lead lengths are kept as short as possible. It is also advisable to select a good low noise 12AX7 if you have the opportunity. In cases where a still lower noise level is desired, it is possible to remove the filament center-tap from ground and return the filaments to ground through a 50-ohm potentiometer that can be balanced for minimum hum and noise level.

Output of the "C A" limiter is +20 dbm to a 600-ohm load. This is sufficient power to drive a speaker or a high power modulator. For those who wish to use the "C A" limiter to drive a commercially built transmitter, such as a Collins 32V3, or a tape recorder, it is advisable to use the optional output circuit. This provides a -25 dbm output, plus attenuation, of all frequencies above 3000 cycles. The low distortion of the "C A" limiter does not make it necessary to have a low-pass filter at the output, but it is quite often desirable for communications and voice recordings.

Applications

Applications of the "C A" limiter are probably more varied than is expected of usual special-purpose amplifiers. Its use to produce a very high average percentage modulation without overmodulation is, of course, a natural. As an amplifier for your phone patch, it can't be beat. It functions extra well as an automatic gain control for conference recordings,

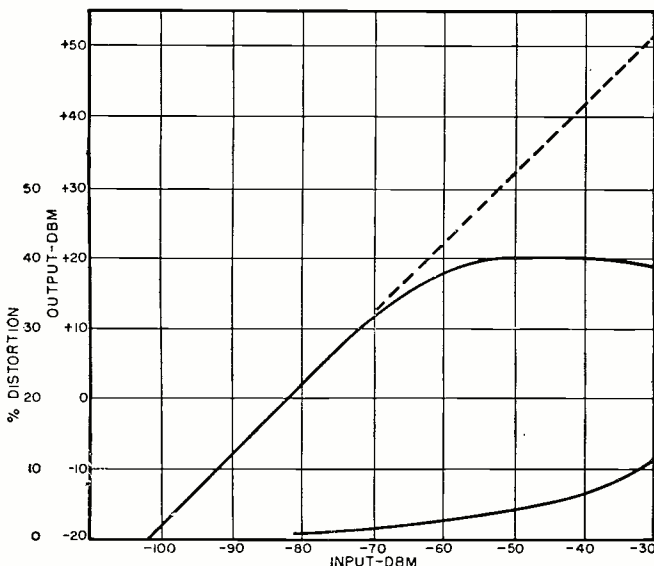

Fig. 3. Upper curve shows consonant amplifier-limiter output versus input. Lower curve is the total harmonic distortion of the special limiter.

¹"Principles of Underwater Sound," National Defense Research Committee Report, Volume 7, 1946

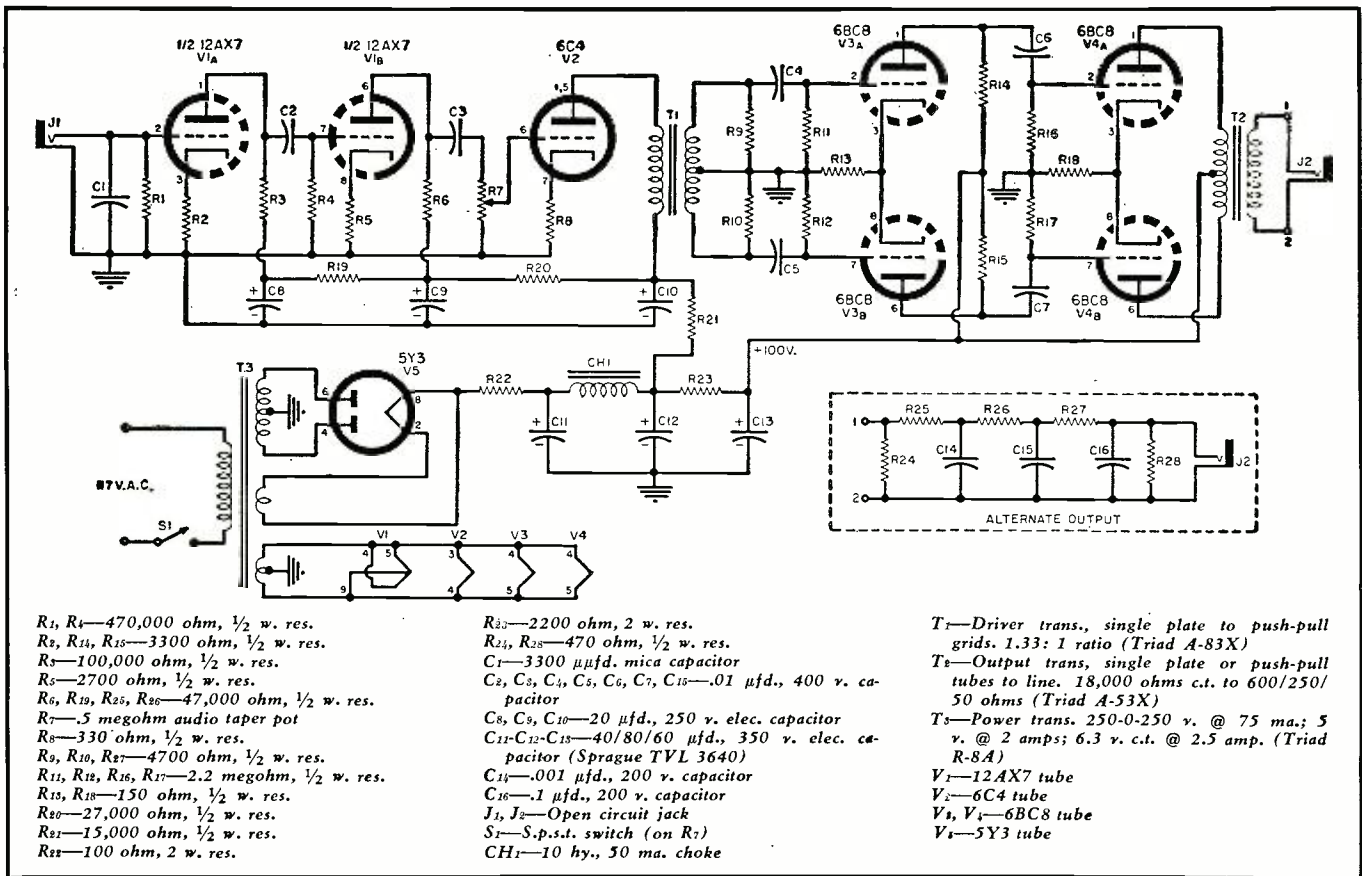

Fig. 4. Complete schematic diagram of the consonant amplifier-limiter circuit. A 12AX7 is utilized as a two-stage pre-amplifier for the 6C4 driver stage. This, in turn, feeds the pair of 6BC8's operating as a two-stage push-pull grid bias limiter.

group pickups, and other such uses.

A not-so-usual application for the "C A" limiter is the output of your receiver. Feed the input through an appropriate pad so that the input stages won't be overdriven and connect a 600-ohm speaker to the output. You may be surprised at how loudly +20 dbm will drive your speaker. If it is too loud you will probably want to insert a 600-ohm variable "L" pad between the "C A" limiter and your speaker.

It will take a few minutes to get used to operating your receiver with a limited output. It is a good idea to tune across the broadcast band at first. Notice the constant loudness of all stations. If the announcers sound like they are sucking their breath through a pipe, you have the input gain too high.

After you have gained the knack of operating your receiver with this new automatic gain control output, tune to your favorite ham band. Tune in the SSB boys and notice how you can now listen without constantly adjusting the gain control. The same thing is true with your favorite net. You won't miss the weak ones because the audio was turned too low and the loud ones won't rattle your speaker.

The "C A" limiter is a simple straightforward piece of audio equipment. There is no feedback circuit to oscillate or motorboat. It will eliminate overmodulation worries forever, but it will give you some new things

to think about. If you have a typical modulator, it is probably designed to give you 25% as much audio power as you have r.f. power. This is fine for unlimited speech. It is also plenty good for limited speech.

If your modulator produces 25% of your r.f. power when driven with a "C A" limiter this will produce a consistent 70% modulation. Before you decide you want 100% modulation, think a little further. What will it cost you and what will you get for your money? You will have to double your modulator's power output capabilities, which means bigger tubes and

a bigger power supply. For this effort and expense you get 3 db more audio at the receiver output at the other end. Can you hear 3 db rise in audio? Sure, if you listen carefully over a high-fidelity system. You will probably notice it more over a typical communications receiver, because that last 3 db produces distortion in receivers that utilize diode-type second detectors. It is doubtful that increased receiver distortion is either useful or desirable. You will get better reports if you keep your modulation at 70 or 80 per-cent with a good high-speed speech limiter.

Fig. 5. Underside of the "C A" limiter showing the simple straightforward construction. Power supply components may be seen near the bottom of the photograph.

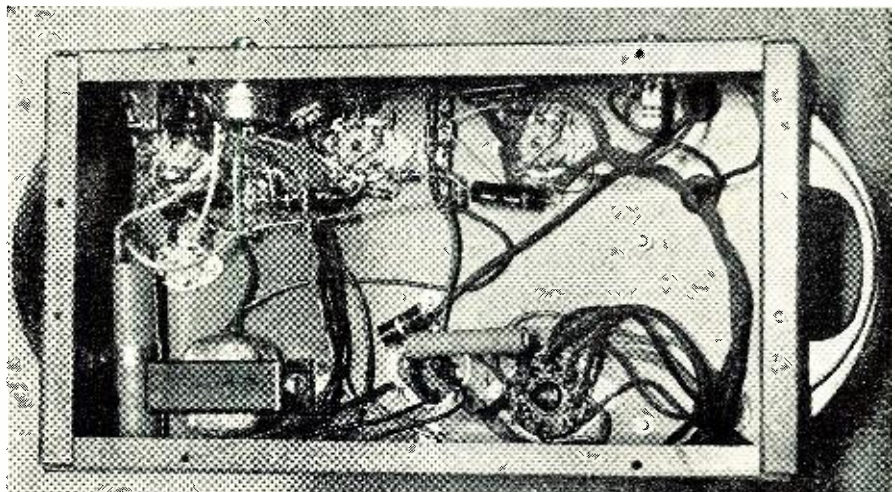

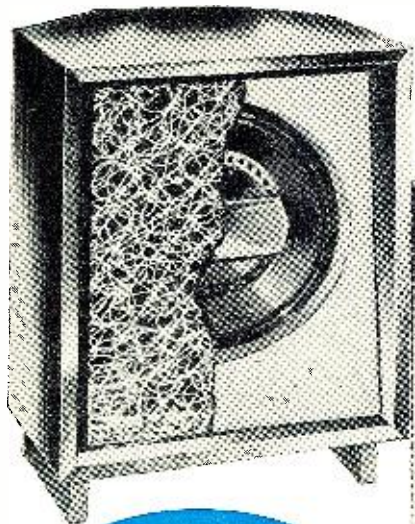

Cut-away assembly views of the "Tiny Mite" showing installation of an integrated 12" 3-way speaker and a 3-way system using an 8" 2-way speaker and a separate tweeter.

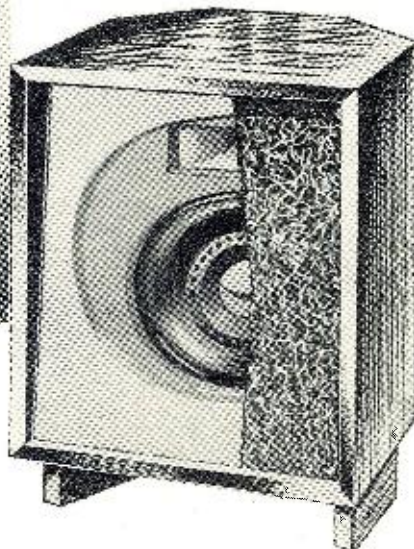

By
ABRAHAM B. COHEN
University Loudspeakers, Inc.

The "TINY MIT" Loudspeaker Enclosure

Construction data and performance of the University "Tiny Mite," a small, ducted-port reflex enclosure.

PATRONS of audio shows of the past will recall the outstanding performance of the original "Tiny Mite," housing the University "Diffusicone 8" speaker. Its wholehearted acceptance for small enclosure applications was so successful as to encourage the redesign of this enclosure to accommodate more speakers than just the "Diffusicone 8." The present design for the "Tiny Mite" embodies proven, small enclosure design techniques, and is specifically adapted to the original University system of Progressive Speaker Expansion whereby it is possible to enjoy basically satisfying reproduction from small hi-fi components which may, through the addition of other components at some future time, expand the original installation into a more versatile high-fidelity system.

It is not necessary to forego the pleasures of good listening where space is limited. To provide satisfactory listening in smaller areas, the "Tiny

Mite" enclosure, as described in this article, should provide more than adequate realization of high-fidelity listening, and at the same time give a substantially satisfactory basis for economical stereophonic installations.

Principle of Operation

The "Tiny Mite" is a modified bass-reflex enclosure utilizing a horn-like duct to couple the cabinet volume to the room. This duct is the channel made up of the base legs of the cabinet which completely close off the sides and back of the bottom and cause the port at the bottom to radiate into the room through the channel thus formed. When used for corner application, this duct is closely coupled to the very bottom of the corner of the room, which provides the optimum corner loading inasmuch as three corner planes are equally operative upon the duct. Thus the port becomes "horn loaded."

Due to the fact that this cabinet is

an intrinsically closed structure, except for the port duct, and specifically does not vent through the rear for corner loading, it may be used to advantage against a flat wall where there is no corner. In this instance the cabinet acts as a bass-reflex enclosure with the duct coupled directly to the floor plane. This bottom duct, then, functions in a dual fashion: (a) when placed in the corner it creates a horn-loaded port enclosure, which naturally enhances the lows and overcomes some of the limitations placed upon the loudspeaker because of the comparatively small enclosure design; (b) at the same time when placed against a flat wall, the presence of the pure duct loading of the bass-reflex enclosure causes the interior volume of the enclosure to perform acoustically in the manner of an enclosure about 40% larger than the actual physical volume. This latter condition likewise enhances the low-frequency response of the enclosure.

It is for the purpose of mutual coupling between the walls of the room and the loudspeaker itself that improved performance of an enclosure is obtained when situated in the corner of a room—the speaker couples itself to all three adjacent walls. Therefore, the closer the loudspeaker may be located to the walls, the better is the coupling. Thus, in the case of the present "Tiny Mite," the fact that the loudspeaker is actually so close to the floor of the room, both when located in the corner or when located against a non-corner type of wall, there is created an improved coupling condition between the loudspeaker and the wall and floor planes which aids the low-frequency response of the system.

The adaptability of the "Tiny Mite" to either corner or flat wall placement is, of course, due to the fact that this enclosure is completely sealed and

(Continued on page 96)

Relative response curves of the Model 6201 12-inch two-way speaker mounted in the "Tiny Mite" enclosure. Curves show comparative response with the enclosure placed in the corner of a room and against a flat wall. The corner position gives a somewhat better bass response, but only by about 3 or 4 db. Note also how the relative response falls off below approximately 80 cps at a rate of close to 12 db per octave.

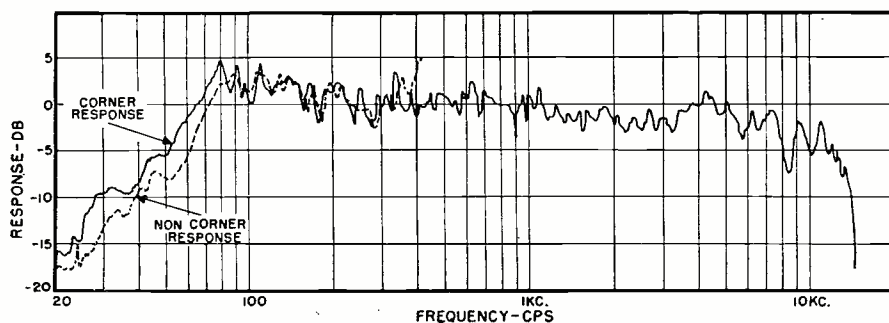

Constructional diagrams for the University "Tiny Mite" loudspeaker enclosure. This relatively small enclosure is a modified bass-reflex type employing a ducted port at the bottom of the unit. The "Tiny Mite" may be installed either in the corner of a room or along a wall, and it will accommodate any 12-inch loudspeaker directly or, by means of an adapter board, any 8-inch speaker with a separate tweeter.

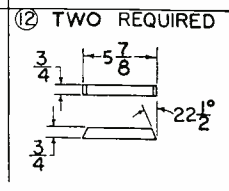
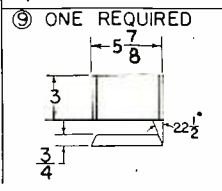
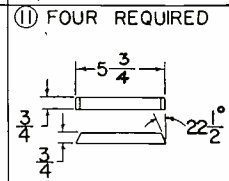
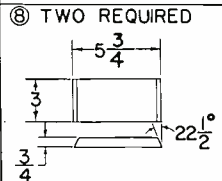
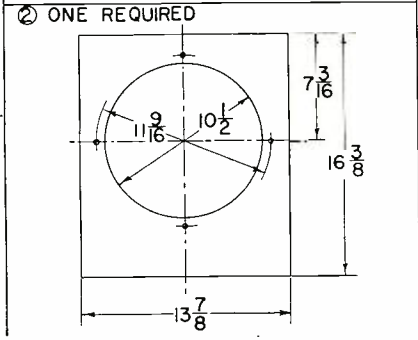
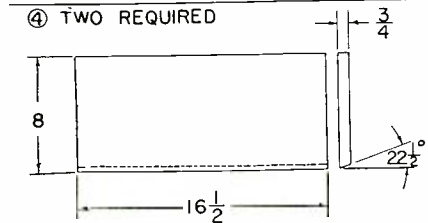
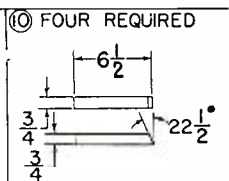
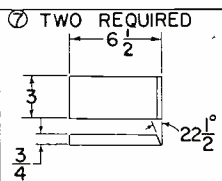
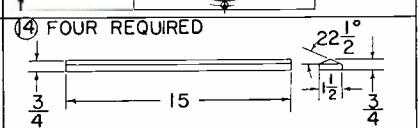
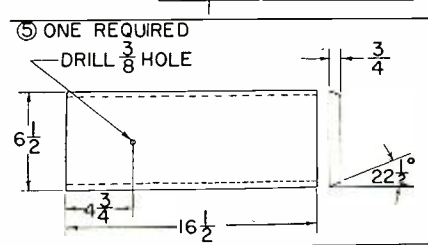
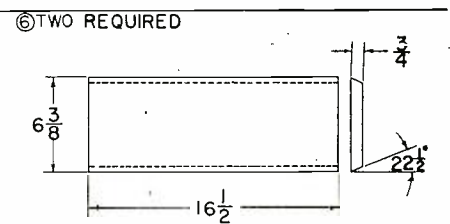
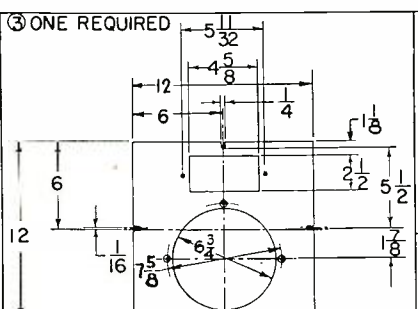
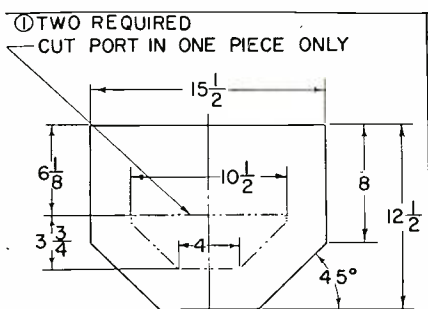
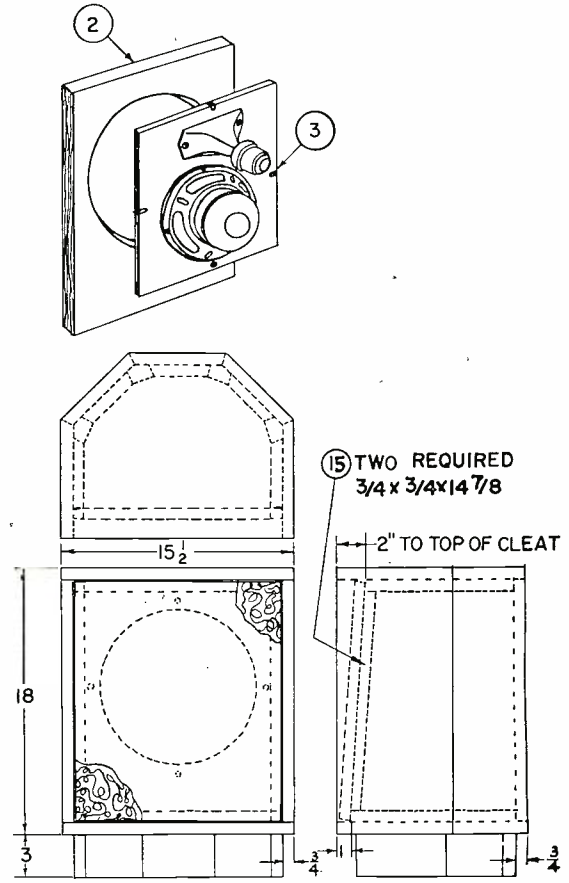
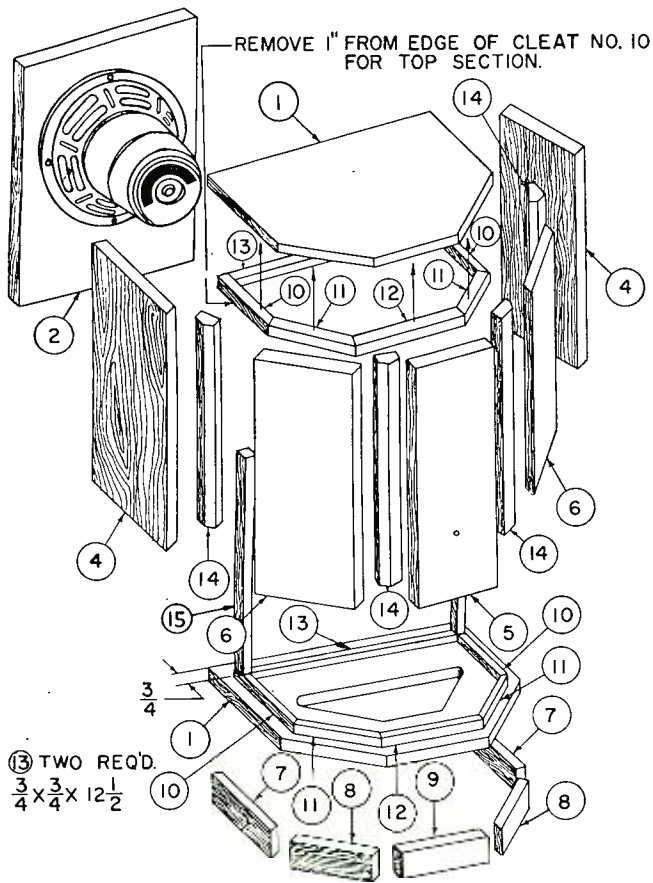

A Transistor Current-Gain Test Set

By
CARL DAVID TODD

Semiconductor Products Dept.
General Electric Company

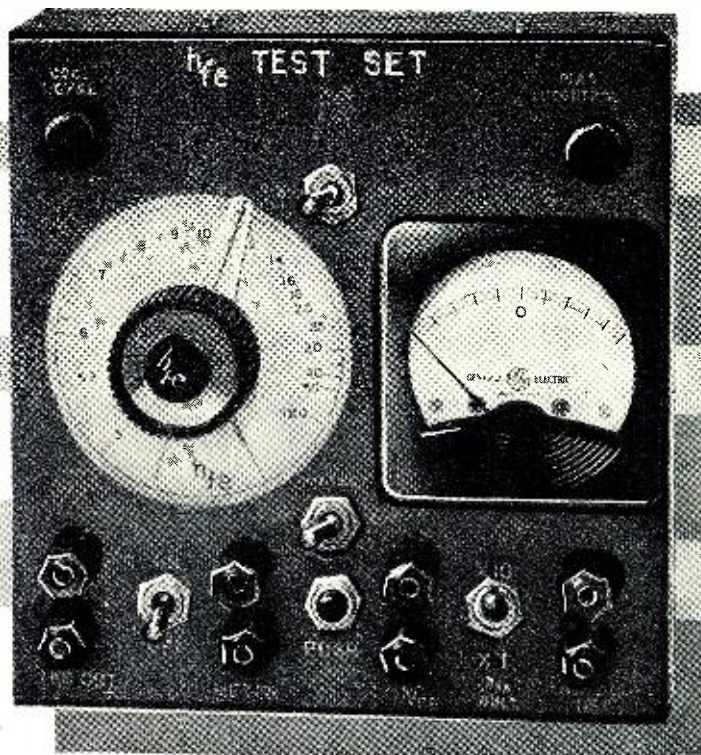

Fig. 1. Front panel view of transistor test set that measures current gain.

Can be used by the service technician and experimenter to check the small-signal current gain of transistors.

THE transistor has had a tremendous impact on the electronic industry as a whole. For several years after its development the transistor was considered a laboratory curiosity by many but this attitude has now undergone a radical change and today the transistor is being used to advantage in many different products. Of major concern to the radio and television technician is the fact that these components are being used in radio receivers which he will have to service. There is, in addition, the possibility that television receivers will incorporate transistor circuitry in the near future.

Two steps are necessary for the technician who wants to be able to handle the servicing of transistorized radio and television receivers. First, he must prepare himself by learning the fundamentals involved. This does not mean that it is necessary for him to obtain a degree in theoretical physics but rather that he should study the simple aspects of the operation and applications of the transistor so that fundamental circuit operations become second nature. Transistors are considerably different from electron tubes and the sooner the technician realizes this the better off he will be.

There are a number of good books available on the subject of transistors, written at several different levels. The book to be studied depends on the student's technical background and experience. In addition to the books there has been a great deal of information

on transistor theory, operation, and application published in this and similar technical magazines.

The second step in preparing for the transistorized equipment repair business is to assemble the necessary test equipment. While it is true that much of the test gear already in the service shop is as applicable to transistors as it is to electron tubes, there are several additional pieces of equipment which, while not absolutely necessary, may be of help to the technician. One such instrument is a device for measuring the relative gain of the transistor. One of the easiest ways to determine this is to measure the small-signal, short-circuit current gain of the transistor in the common emitter configuration. This quantity is described in transistor symbolism as h_{fe} . This measurement may be made by feeding a small a.c. signal into the base of the transistor with operating biases applied, and then measuring the a.c. collector current which results when the collector is bypassed with a large capacitor. The h_{fe} of the transistor is approximately the ratio of the a.c. collector current to the a.c. base current. Since it is rarely practical for the technician to measure the small currents involved, some other method must generally be employed for this test.

The test set to be described employs a very simple method and yet gives very good results.

As stated, h_{fe} is merely the ratio of the a.c. collector current to the a.c.

base current. In addition to this, several things must be kept in mind. First, this measurement must be made with the proper d.c. biases applied to the transistor. Secondly, the external collector circuitry should be practically a short circuit as far as the a.c. signal is concerned. Finally, the amplitude of the a.c. currents should be much less than the d.c. bias currents. For simplicity, the a.c. circuitry will be shown first; the methods for obtaining the proper d.c. biases will be shown later.

In the circuit of Fig. 2, an audio signal generator voltage, E_g , is used to produce a base current, I_b . This small a.c. current is amplified by the transistor and produces I_c in the collector circuit. The base current, I_b , will produce voltage, E_1 , across the resistor R_b . Also, the collector current, I_c , will produce a voltage, E_2 , across the resistor R_c . Now as long as R_c is a fairly small value, say on the order of 1000 ohms or less, the I_c flowing will be very nearly equal to the value which would flow if the collector were shorted to the emitter.

The value of h_{fe} is given by the relationship:

$$h_{fe} = I_c / I_b$$

and the voltages are:

$$E_1 = I_b R_b, \quad E_2 = I_c R_c$$

This allows the currents to be found.

$$I_b = E_1 / R_b, \quad I_c = E_2 / R_c$$

Putting these values for the currents back into the relationship for h_{fe} :

$$h_{fe} = \frac{E_2 / R_c}{E_1 / R_b}$$

Most of the components are by no means critical and may be varied over a fairly wide range. The only parts which should be precise are the two resistors (R_7 , R_8) used for " R_b " and the calibration of the potentiometer (R_{10}) used for " R_c ." The accuracy of the results obtainable is a direct function of the accuracy of these resistors.

To calibrate the dial for current-gain, the values for the calibration points must be calculated by use of the relationship:

$$h_{fe} = R_b/R_c$$

or, a more useful relation is:

$$R_c = R_b/h_{fe}$$

R_c must be measured by the use of a good quality ohmmeter or an impedance bridge. Of course, the more accurate the calibration of the resistor, the more accurate the readings which may be obtained. Fig. 3 is a reproduction of the instrument's dial face.

It will be noticed that the value of R_4 , the base bias resistor for the transistor phase-shift oscillator is listed as 330,000 ohms. This resistor should be chosen to give optimum output and waveform.

If current-gain is to be measured at some other frequency, then the values of the capacitors in the oscillator circuit may be changed. The values indicated give an operating frequency very nearly equal to 1000 cps. If the values of the capacitors are decreased, the frequency of oscillation will rise, and if the capacity is increased, the frequency will decrease. The same result may be obtained by changing the resistor values although this did not seem to give good results.

It may prove desirable to make the emitter current measurement by the use of an external meter. This may be done very easily and results in a saving in space.

In addition, the use of an external signal source may be preferred. This may be done only with caution since there is no common ground for the signal source and the null detector, thus giving rise to the possibility of hum pickup problems as well as a shunting

effect across the precision resistors used for " R_b ." However, if an isolation transformer is used between the signal input and the oscillator, the external source may be used fairly successfully.

Operation and Use

With the oscillator and bias controls set at minimum positions and the $p-n-p-n-p-n$ switch S_2 in the proper position, the transistor to be measured is plugged into the socket. With the power switch turned on, the emitter current "Push-to-Read" button S_3 is depressed and the desired d.c. emitter current is fixed by adjusting the base bias potentiometer and reading the value on the meter. The collector voltage, V_{CE} , may be measured by connecting a voltmeter to the terminals provided. Before proceeding any further, the voltmeter leads should be removed to prevent hum trouble or problems arising from stray capacitance.

With a suitable null detector such as a high-gain oscilloscope or audio amplifier connected, the input level control should be advanced until a suitable indication is obtained at the null detector. The test instrument's dial is rotated until a null or minimum reading is obtained. The value shown under the pointer multiplied by the proper factor determined by the value of " R_b " selected is the value of the h_{fe} of the transistor in question and at the bias levels previously set. It should be realized that h_{fe} is a function of the emitter current and also the collector voltage. However, if the value is known at one operating point not too far from the desired one, then the value at a given level may be approximated by the use of curves supplied by the manufacturer. Several curves applying to *General Electric* transistors are shown in Fig. 6.

In service work, there are several times when a measurement of the h_{fe} of a transistor will provide some valuable information. For example, if a radio has very low volume, it may well be that the current-gain of the transistors in the audio stages has decreased. Also, if it becomes necessary

to replace the push-pull pair of transistors in the output stages of a transistorized receiver, two transistors having approximately the same h_{fe} should be used. It would be preferable to check the match at a higher current level than is possible with this test set, but even this test will be helpful.

If a transistor is suspected of being defective, it should be checked to see if it has an h_{fe} reasonably close to that specified on the data sheet for that particular transistor. In addition to indicating a transistor which has low gain, this test set will also indicate a transistor which has shorted or open elements. The latter two defects will be indicated when no null is possible, or when no output signal is present irrespective of the position of the dial setting.

The 1000 cps signal may be used externally by connecting to the two terminals provided. The oscillator level control is the output amplitude adjustment.

The 0-1 ma. meter terminals are available externally through the binding posts provided. The meter switch must be in the "Ext." position.

If desired, the test set may be used as a 1000 ohms-per-volt voltmeter by connecting the positive side of the voltage to the positive meter binding post, connecting a jumper wire from the negative meter binding post to the emitter side of the V_{CE} binding posts, and connecting the negative side of the voltage to the grounded null detector binding post. When the meter switch is in the "Ext." position and the h_{fe} multiplier switch is in the "X 1" position, then the meter reads 5 volts full scale. When the multiplier switch is in the "X 10" position, the meter reads 50 volts full scale.

This test set, when properly built and calibrated, can provide the technician or experimenter with fairly accurate measurement of the current gain of the transistor. When properly used, the information obtained can aid the technician in his work on transistorized equipment. -30-

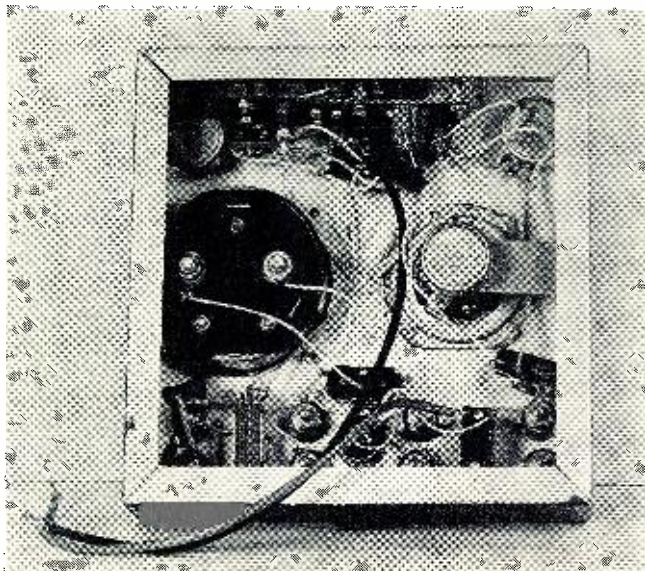
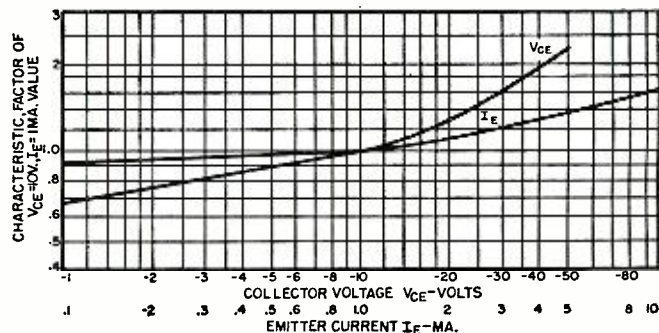

Fig. 5. Under-chassis view of the transistor test set. The 2N107 transistor used as the phase-shift oscillator is mounted on the fiber board at the top of the photo.

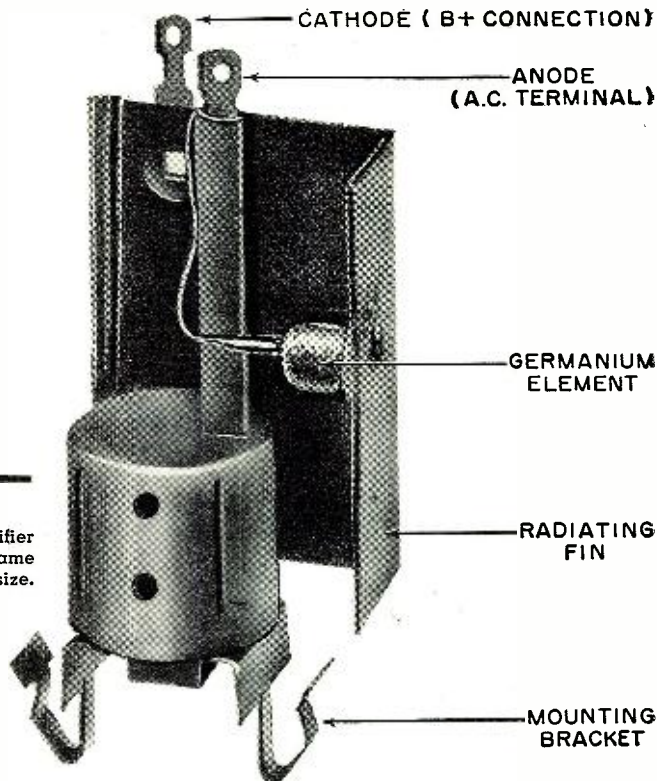
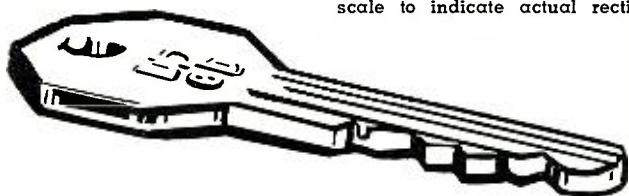

Fig. 6. Approximate curves showing variation of h_{fe} with collector voltage and emitter current for the *General Electric* low frequency "p-n-p" transistors.



New Long-Life TV Rectifier

Fig. 1. The 1N573 germanium rectifier and the house key are drawn to the same scale to indicate actual rectifier size.



Germanium diodes, now in new TV sets, are also available as replacements for selenium units.

THE FIRST line of germanium rectifiers specifically designed for TV power supplies is being incorporated in new TV receivers just reaching the market or about to reach the market as you read this. The new semiconductor units are being produced in quantity, at prices competitive with selenium rectifiers, by the *General Electric Company*.

Equally as important as the news that these units are being incorporated in original equipment is this follow-up announcement: these germanium power diodes are also being made available through parts jobbers in a form that will permit use as replacements for the more conventional selenium diodes found in countless receivers already in use.

There is nothing new in using germanium as the element in a crystal rectifier. Historically, this material antedates selenium in such a role. Also, it has been known to enjoy certain advantages over selenium. However, until recently developed production techniques cut back the cost of manufacture sharply, germanium rectifiers could not be made available at the voltage and current ratings required for use in TV and radio power applications except at prohibitive prices. These new units are competitively priced.

The first three rectifiers to appear in the line are RETMA types 1N573, 1N575, and 1N581. The first is a half-wave unit that delivers 250 ma. of d.c. output. The 1N575, also a half-wave rectifier, is designed for 350-ma. output. The 1N581, consisting of two rectifiers already connected in a voltage-doubler configuration, is rated at 250 ma.

Full-cycle average full-load voltage drop for these devices is very low: a maximum of .15 volt for the 1N573 or the 1N581, and a maximum of .3 volt for the 1N575. Maximum peak inverse voltage ratings of 380 volts apply to all three. Also, each of them is designed to be used with a 4-ohm surge-limiting resistor. The units are hermetically sealed in metal cases and are warranted by *General Electric* for one year.

Physically, the units are smaller and lighter than their selenium counterparts and, even at the small size of the entire unit (see Fig. 1), most of it consists of a radiating surface or heat sink and a mounting bracket. The ac-

tual germanium element is much smaller than a dime. On the rectifiers being shipped to set manufacturers, the mounting bracket is a mechanical snap-in type to keep chassis assembly costs down and also to streamline later replacement. The types being produced for field replacement of selenium rectifiers are electrically identical to these, but have brackets that will permit direct mounting, where conventional selenium devices were used, without any physical alteration.

In germanium rectifiers, as in the silicon rectifiers introduced over a year ago, there are only the crystals of a single element to deal with, rec-

(Continued on page 144)

Fig. 2. Typical voltage regulation curves for the 1N573 germanium rectifier when used in a half-wave circuit with capacitive load, for three values of capacitance. A comparable curve for a selenium rectifier is also included.

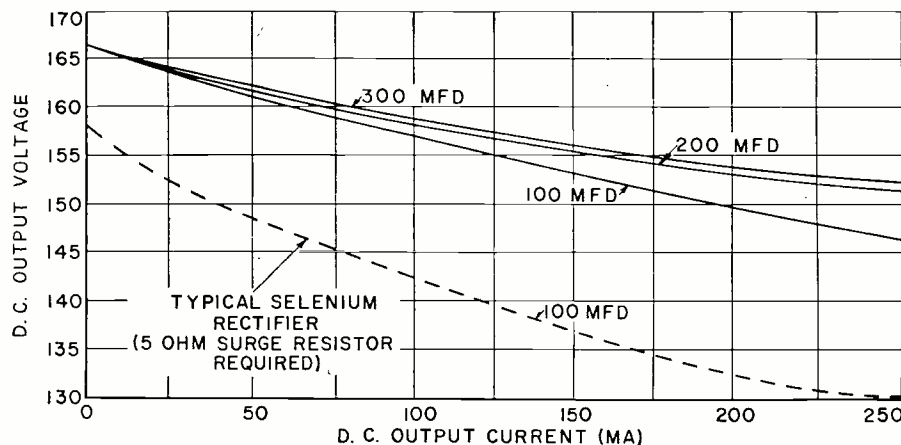

The Service Industry



and Public Relations

By WILLIAM LEONARD

The record of organized independent service is one of overlooked opportunities to win good publicity.

KARL HEINZMAN, president of the Television Service Association of Michigan, summed up the evils that beset the independent electronic service industry in three categories; (a) bait advertising, (b) shoddy workmanship, and (c) unethical and irresponsible competition.

The Michigan association sponsored the Detroit television licensing ordinance that was passed by the city council last year. This law requires that both dealers and technicians who handle television service hold licenses for their classification of activity. TSA is now embarked on a broad program which includes:

1. The complete organization of all service dealers.
2. A technicians' training program.
3. A business training program for service dealers.
4. A program to better consumer-service dealer relationships.

While the TSA program may have advanced further than that of most other service associations, it represents, in essence, the objectives that will improve the business atmosphere of the industry.

The major difficulty that has consistently impeded the realization of service-association objectives has been the ruggedly independent nature of the

average radio and TV service technician. Another impediment has been the lack of foresight and the detached interest on the part of the average dealer in his work as business activity. As one dealer said when he dropped out of his association, "A good many service technicians would rather take a beating than collect adequate charges for their time, knowledge, and skills."

Another factor responsible for a major area of disagreement between men engaged in consumer service is the difference in perspective between businessmen who operate service businesses and technicians who run service shops. The former are promotion-minded business opportunists who feel that the majority of service problems must be solved by the service industry itself. The latter lean toward the philosophy that only an external agency, such as a legally empowered license board, can eliminate the crooks and the incompetents from the service field.

While chasing the will-o-the-wisp benefits from such nebulous objectives as municipal and state licensing, the majority of service dealers and technicians have failed to take advantage of the numerous newspaper articles and magazine feature stories that provided unusual possibilities for effective local public-relations campaigns.

Bait advertising has been the bane of every honestly operated, competent, service business. It ranks at the top of the list with practically all service associations as the scourge of the service activity. Set owners who see ads offering home service calls for as little as two dollars berate legitimate shops that honestly charge for labor time. Service dealers feel that a public relations program is necessary to acquaint set owners with the basic facts about operating and service costs.

Last spring, news stories appeared in practically all of the leading papers citing the list of the "ten worst buys" issued by the Federal Trade Commission. The FTC issued a warning to the public to beware of advertisements with offers that appeared "too good to be true." "Television repair come-ons" were listed as one of the ten worst buys that are widely advertised. The Federal Trade Commission advised the public to (1) deal only with reputable concerns whose claims can be trusted, and (2) beware of exaggerated claims.

This FTC release appeared on the press wires as a two-column story. Most metropolitan newspapers picked it up and ran it under the caption "How to Get Hooked." It was easily the best piece of public relations copy honest dealers could hope to get.

How many service dealers took advantage of this "publicity break?" How many service associations capitalized on it either through advertising or customer give-away pieces? Here was a made-to-order opportunity to bring pointedly to the public's attention the fact that associations are made up of carefully screened service
(Continued on page 125)

G-E CLARIFIES SERVICE POLICY

AT A meeting held in New York City, representatives of the General Electric Co. expounded a policy of close cooperation with independent service dealers. As outlined by J. T. Thompson, mgr. of G-E tube sales, the program will take effect on several different fronts:

1. Replacement parts for TV sets will get broader distribution, through distributors now franchised for tubes, to insure availability to independents.
2. The Product Service Div. has discontinued its ad campaign, to which objections had been raised by independent service. It will avoid future ads that "can be interpreted by independent servicemen as derogatory to them."
3. The continuing campaign to help service dealers is being stepped

up. Soon ready will be a depth course in service business management, special plans for service shop layouts, in-factory technical training, and a 1957 ad campaign promoting local independent service.

This statement followed widespread reaction by service after G-E had announced earlier plans to provide service to TV set owners. At that time, local distributors were given the option of authorizing local independents to perform this service—or setting up their own service departments. While there is no official change in this policy, G-E says it intends to use "friendly persuasion" with distributors to see that actual work on the sets is ultimately performed by members of the independent service fraternity.

—50—



The FM tuning indicators shown here include the 6E5 and the 6AL7 tuning eye tubes along with a space-saving, side-indicating type tuning meter.

Adding an FM Tuning Indicator

Methods and circuits for incorporating various tuning eyes and meters in FM receivers or tuners.

HIGH QUALITY FM reception requires that noise and distortion be kept low. Both offending factors are held to a minimum when an FM tuner is set *exactly* at the carrier frequency of a station on the air.

Most high priced FM tuners facilitate accurate tuning by automatic frequency control (a.f.c.), which also serves to overcome oscillator drift. Such a.f.c. is a self-correcting feedback device. Accuracy of tuning depends primarily on oscillator frequency, which is varied over a small range by a tube that acts as a variable reactance in the oscillator circuit. In turn, the reactance tube is controlled by a voltage, applied to the grid, which is obtained from the audio detector and varies in polarity and magnitude with accuracy of tuning.

In addition to a.f.c., some FM tuners also contain a meter or electron-ray tube (tuning eye) to assist in selecting a station. Although it may seem redundant where a.f.c. is available, the tuning indicator is useful in several ways. Where stations are very close together, it may be necessary to defeat the a.f.c. (temporarily or permanently) in order to prevent a strong station from "capturing" the spot on the dial occupied by a weak one. With a.f.c. removed, the indicator is very helpful in getting the tuner on-station. Even with a.f.c. present, the tuning indicator provides corroboration of correct tuning, as well as psychological comfort to the meticulous audiophile.

Some FM tuners have no a.f.c. and, in this case, a reliable tuning indicator of some sort is all-important. Among the expensive tuners on the market there are several without a.f.c., but nearly all contain an indicator. However, there are a number of inexpensive

tuners which have neither a.f.c. nor an indicator. Reception with such instruments, particularly of weak stations, may be unsatisfactory because it is difficult to do a good job of FM tuning by ear alone.

Where the FM tuner is slightly off-station, the quieting effect of an incoming signal on tuner noise is reduced. Even more important, harmonic and intermodulation distortion, particularly at high modulation levels, increase. In FM the audio voltage produced at the detector varies with the instantaneous deviation of the r.f. signal from the station's center (carrier) frequency. If the tuner is set exactly at the center frequency, deviations above and below this frequency will both fall within the tuner's passband, which is roughly 200 kc. A fully modulated signal has a bandwidth such that if the tuner is set above or below the station's carrier frequency, some of the sidebands will fail to get through the passband adequately. Therefore the detected audio signal fails to correspond to the original transmission, which means distortion.

Clearly, then, for best FM reception it is necessary to have either a tuning indicator or a.f.c.; it is also nice to have both, with the option of reducing or defeating the a.f.c. when it obstructs tuning selectivity.

Types of Indication

Tuning indicators provide either of two types of indication, and sometimes both. One type shows the relative

magnitude of the tuned signal. Since in correctly aligned equipment the maximum signal corresponds to center-of-channel tuning, such a device is usually satisfactory.

The other type of indication goes directly to the matter and shows whether the tuner is below, above, or at the carrier frequency.

At high modulation levels, a slight departure of the tuner from center frequency can seriously increase distortion. Thus, particularly from the viewpoint of the audiophile who insists on utmost performance by his equipment, a center-of-channel indication is highly desirable. Some of the top-flight tuners have two meters, one for showing magnitude of the tuned signal and the other for center-of-channel indication.

Meter Versus Tuning Eye

For a long time the tuning eye has been the most popular type of indicator found in the general run of FM tuners, but there has been a recent trend toward meters. The indication provided by a meter, though not necessarily more accurate, is easier to read. Thus the maximum swing of a pointer or its swing to center-of-channel (mid-scale) is somewhat easier to identify with precision than the corresponding fluorescent images on an electron-ray tube. On the other hand, the meter is more costly than the tuning eye.

The following discussion shows some of the methods that can be used for

incorporating electron-ray tubes and meters as FM tuning indicators. Both maximum signal strength and center-of-channel indicators are discussed. In some cases, depending upon the available space and the owner's ingenuity, it may be feasible to install the indicator in the tuner. In other instances it

will be necessary to mount the indicator "outboard," for example on a panel.

Signal Strength Tuning Eye

The 6E5 electron-ray tube, popular in varied applications, is often used as an FM tuning indicator. This tube presents a green fluorescent pattern, circular except for a pie-shaped shadow which varies from 90° to 0° depending on signal strength. The eye is open (maximum shadow) when no signal is received and the eye is partially or fully closed at maximum signal. The pattern sequence as one tunes a station is shown in Fig. 1.

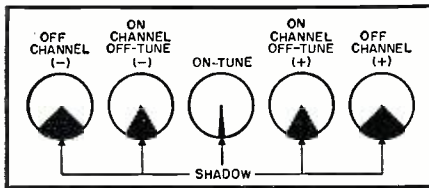

Fig. 1. Sequence of patterns produced on 6E5 as receiver is tuned through channel.

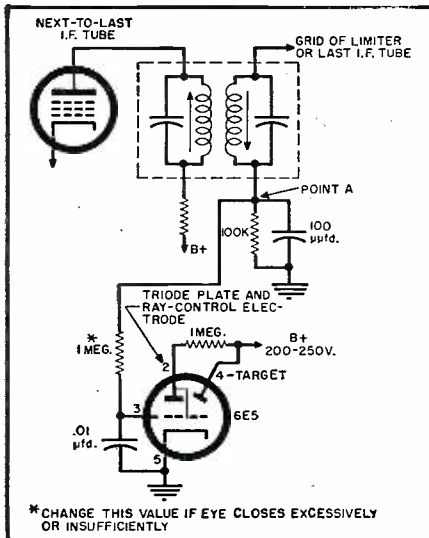

Fig. 2. Schematic diagram showing how 6E5 is connected for FM tuning indication.

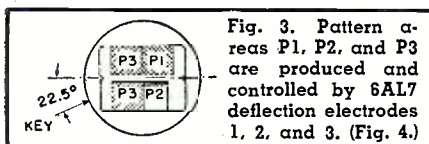

Fig. 3. Pattern areas P1, P2, and P3 are produced and controlled by 6AL7 deflection electrodes 1, 2, and 3. (Fig. 4.)

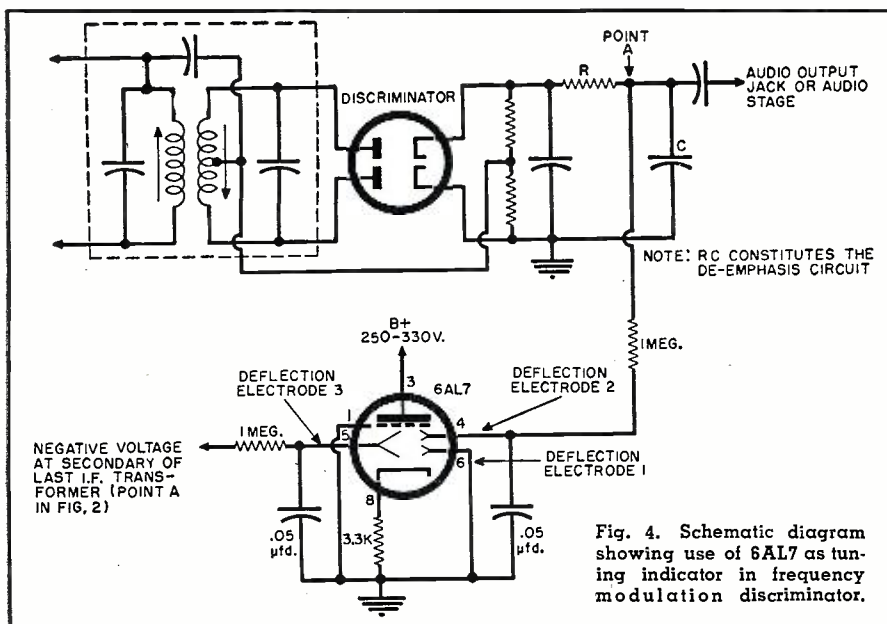

Fig. 4. Schematic diagram showing use of 6AL7 as tuning indicator in frequency modulation discriminator.

secondary and ground, as shown in Fig. 2, one may obtain the voltage required to drive the 6E5. When this is done, the i.f. alignment and gain should be checked to see that they have not been adversely affected.

It should be pointed out, however, that a disadvantage of using this method is that on strong signals, the maximum voltage at the i.f. amplifier or limiter grid may not be sharply defined and exact tuning may be difficult.

Center-of-Channel Tuning Eye

The 6AL7 (or 6AL7-GT) electron-ray tube can indicate not only center-of-channel tuning but signal strength as well. Although the 6AL7 costs more than the 6E5, it is worth the difference. The customary net price (40% off list) is about \$2.45 for the 6AL7 and \$1.40 for the 6E5.

A hardware kit for mounting an eye tube (containing a socket with pigtail leads, mounting bracket, escutcheon, etc.) is available at radio supply houses for about \$1.60.

The elements of the 6AL7 are shown in Fig. 4. The plate serves as the target for the electron stream, while three deflection electrodes control the shape of the fluorescent pattern. Fig. 3 shows the pattern area affected by each electrode while Fig. 5 indicates the pattern sequence as tuning takes place. When the station is properly tuned in, assuming the tuner is accurately aligned, the two vertical bars are of exactly equal width, which indicates that the tuner is set at the carrier frequency. Also, the bars are of minimum width, which corresponds to maximum signal strength.

Fig. 4 also shows how a 6AL7 is connected to an FM tuner containing a Foster-Seeley discriminator. Electrode 3, which controls the left-hand side of both bars and thereby regulates their width, goes to a source of negative voltage, in this case the bottom of the secondary of the last i.f. transformer. Electrode 1 is grounded, and electrode 2 is controlled by the d.c. component at the discriminator output. An RC network filters out the a.c. component present at the discriminator. When the tuner is set at the carrier frequency, d.c. voltage at the discriminator is zero. Thus there is no voltage differential between electrodes 1 and 2, so that pattern area P₂ is the same as P₁ (Fig. 3), producing bars of equal width. When the tuner is off-frequency, either a positive or negative voltage appears at the discriminator, which means that electrode 2 goes positive or negative with respect to electrode 1, and pattern area P₂ becomes wider or narrower than P₁.

Fig. 6 shows how a 6AL7 may be hooked up to a balanced ratio detector circuit of the type now in common use. The negative voltage for electrode 3 is obtained at the negative end of the large capacitor; electrode 1 goes to ground as before; and electrode 2 is connected to the audio output through an RC network that filters out the a.c.,

leaving the d.c. component, which varies from negative polarity to zero to positive polarity as one tunes through an FM channel.

Fig. 7 shows how a 6AL7 may be connected to one type of unbalanced ratio detector.

Fig. 9 shows another type of unbalanced ratio detector and the recommended method of using a 6AL7. Note that the connections for electrodes 1 and 3 are substantially different than in the other diagrams and, accordingly, the tuning pattern sequence is also different. However, the conventional pattern sequence shown in Fig. 5 could be obtained by connecting the 6AL7 in the same manner as in Figs. 6 and 7, except that the negative voltage for electrode 3 (pin 5) would be obtained from the secondary of the last i.f. transformer, as shown in Fig. 4.

For still other ratio detector configurations, information on using a 6AL7 may be obtained from the manufacturers of such tubes.

Signal Strength Meter

If it is desired to incorporate a signal strength meter, one way in which this can be done is shown in Fig. 8, the negative control voltage being derived from an i.f. stage in a fashion previously discussed. This hookup requires a tube to drive the meter, which can be a 1 mA. movement. A 6C4 or half of a 12AU7 is suitable. However, the reader should bear in mind the previously cited disadvantage of a simple signal strength (obtained in i.f. grid circuit) *versus* a center-of-channel indicator.

With zero voltage at the grid of the tube, the pot is adjusted so that the voltage at the high side of the pot equals that at the cathode. Thus there is no potential across the meter and no deflection of the pointer. When a signal is received, the grid goes negative, reducing the voltage at the cathode and producing a voltage drop across the meter. If the pointer is driven off-scale by strong stations, it is necessary to increase the value of the 470,000 ohm resistor in Fig. 8.

Center-of-Channel Meter

Fig. 10 shows how to incorporate a center-of-channel tuning meter. A 6C4 or half of a 12AU7 drives a zero-center meter, which may be a .5-0-.5 ma. movement.

With zero voltage at the grid, the balancing pot is adjusted so that the voltage at the high side of the pot equals that at the cathode, causing the zero-center meter to read mid-scale. The d.c. voltage at the audio output is applied to the grid of the tube. When the tuner is on-channel but off-tune, the voltage at the detector and therefore at the grid of the driving tube goes either positive or negative, and accordingly the meter pointer swings left or right. If insufficient or excessive drive is applied to the meter, it is necessary to increase or decrease the value of the 1 megohm grid resistor, which forms part of a voltage divider.

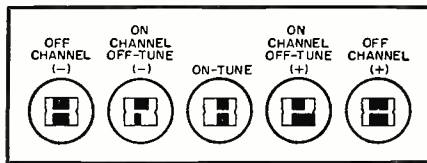

Fig. 5. Pattern sequence on 6AL7 as FM receiver is tuned through channel.

Zero-center meters are not always available at radio supply houses. However, they can be had on direct order from most leading manufacturers of meters, such as *Simpson, Triplett, Weston*, etc. Prices range from about \$10 to \$15 for a 3" meter having a sensitivity of .5-0-.5 ma. Adding the cost of a tube and related components, it may readily be seen that the cost of installing a center-of-channel meter is about three to four times as great as that of installing a center-of-channel indicator in the form of a 6AL7.

By using a d.c. meter of greater sensitivity than a .5-0-.5 ma. movement, one can dispense with the driving tube. It is then merely necessary to connect the meter *via* a series resistor to audio output point A as shown in Figs. 4, 6, 7, and 9.

When a fairly sensitive FM tuner is de-tuned from the center frequency of a normal FM signal, without going completely off-channel, this produces ± 5 volts or more at the audio output; the voltage of course returns to zero when the tuner is dialed either to center frequency or off-channel. Given a meter of sufficient sensitivity, the varying d.c. voltage at the audio output can drive the meter directly. A tuner with poor sensitivity will require a relatively more sensitive meter.

The minimum value of the series resistor should be, in conjunction with resistor R in Figs. 4, 6, 7, 9, about 100,000 ohms, otherwise the low resistance of the meter will cause undue loading effects. Assuming an off-tune deflection of 5 volts, a current of 50 microamperes will flow through the 100,000 ohm resistance. Consequently a meter with a 50-0-50 microampere movement would suffice. In fact, a 100-0-100 microampere movement will

(Continued on page 101)

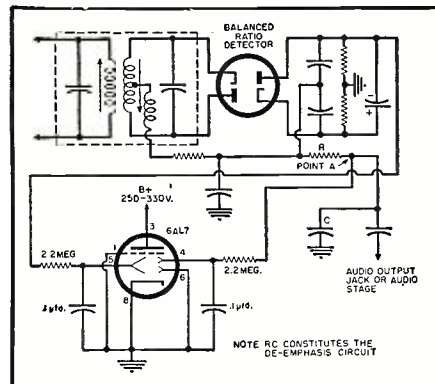

Fig. 6. Schematic diagram showing 6AL7 as tuning indicator in balanced ratio detector.

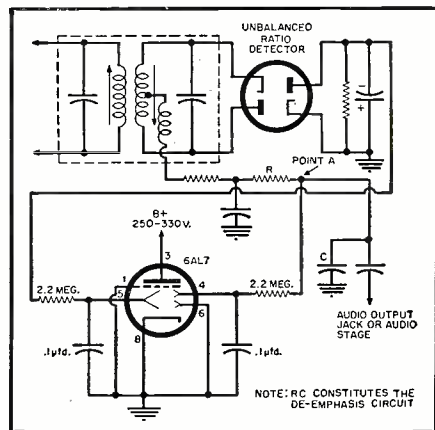

Fig. 7. Diagram showing 6AL7 as tuning indicator in unbalanced ratio detector.

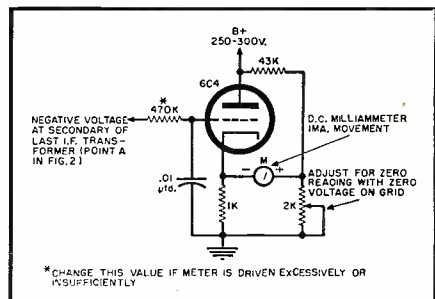

Fig. 8. Simple schematic diagram showing use of conventional d.c. milliammeter connected to driver tube for signal strength indication.

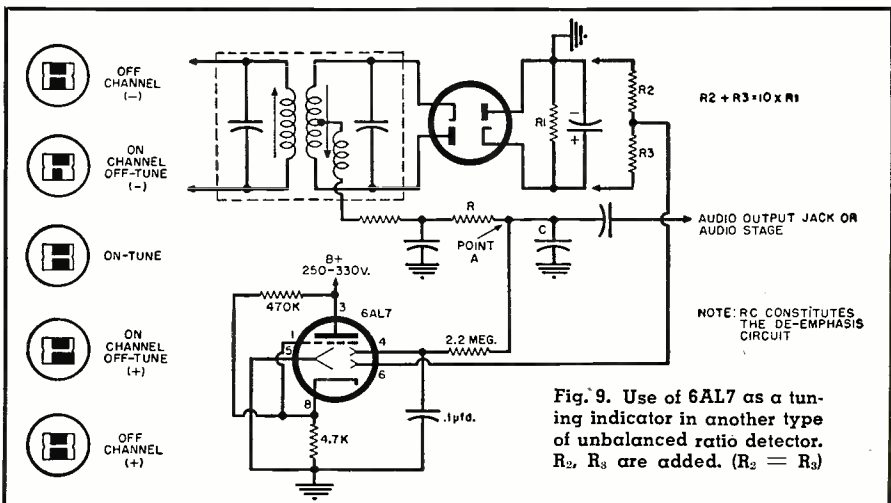

Fig. 9. Use of 6AL7 as a tuning indicator in another type of unbalanced ratio detector. R₂, R₃ are added. (R₂ = R₃)

Loudspeaker Damping

and Tonal Response

By

GEORGE L. AUGSPURGER
Audio Research Laboratories

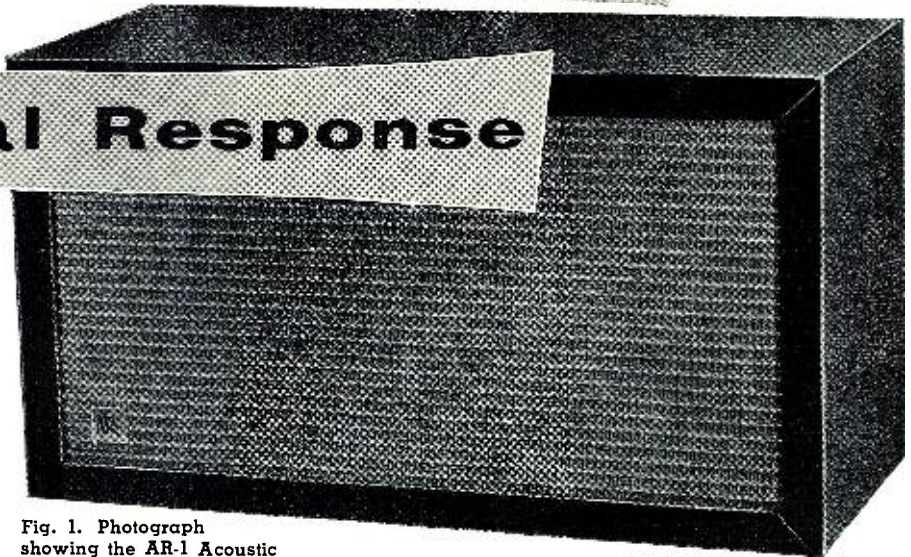

Fig. 1. Photograph showing the AR-1 Acoustic Suspension System speaker enclosure.

Recommendations for the proper setting of variable damping control for various types of speaker systems.

A GREAT DEAL of material has been written about loudspeaker damping—the significance of critical damping, the relationship of speaker efficiency to optimum damping, the use of variable damping to reduce distortion, and so on. Somehow in the excitement over this new technique a general impression has arisen that the only audible effect of juggling damping factors is a shift in apparent bass efficiency.

This is generally true in practice because most amplifiers are designed so that the damping control regulates only the range below 400 cps or so. Some circuits even include corrective filters to help compensate for the

Fig. 2. (A) Measured impedance and (B) axial response of actual system. (From Langford-Smith, "Radiotron Designer's Handbook.")

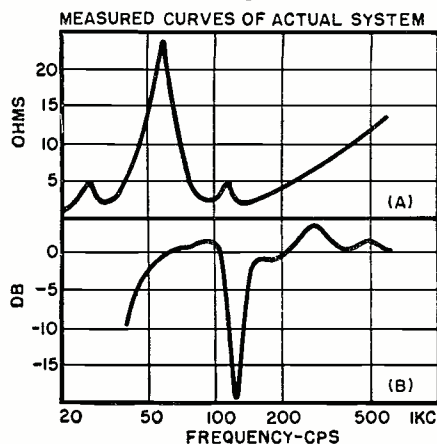

change in bass efficiency as damping is varied. This change, however, is not necessarily the smooth sort of variation one gets with tone controls. It is related to the impedance curve of the speaker system used and by looking at some simplified curves we can get a general idea of what happens.

Knowing the response curve of a given speaker system with constant voltage drive and its impedance curve as well, it is easy enough to get a rough idea of what will happen with various damping factors by setting up two other general cases. The first is the constant current (I_c) system where driving voltage follows impedance, and the second is the negative impedance ($-Z$) system in which driving voltage is inversely proportional to impedance variations.

Fig. 3 is a common family of curves for a loudspeaker in an infinite baffle. Fig. 3A is the impedance curve and 3C might be the axial response of the same speaker driven by a constant voltage source. This is the same thing as saying that the amplifier has good regulation, or low internal impedance, or a high damping factor. Factors from 5 to infinity fall in this general classification.

Since impedance below 500 cycles is almost purely motional, the curve of Fig. 3A is also representative of relative cone travel. With a constant voltage source, the increased cone movement at resonance tends to offset the loss due to poor acoustic coupling and the response is reasonably smooth.

But if the speaker is driven from a constant current source, curve Fig. 3B is the acoustic response. A constant current source is an amplifier with very high internal impedance, poor regulation, and a damping factor of about 0.1 or lower. The output voltage rises with impedance, the cone is driven harder at resonance, and a ubiquitous boom is heard throughout the listening room. Notice that even in these simplified examples, the peak of Fig. 3B is not the sort of thing one can flatten out with tone controls.

What happens if the output voltage follows an inverse relationship with impedance changes? This is the situation of Fig. 3D where damping has been shifted to the negative region and amplifier internal impedance is less than zero. In the case of extremely inefficient speakers, the amplifier impedance may be made negative without even reaching the curve of Fig. 3C, much less the 6 db-per-octave slope of Fig. 3D.

Although most enclosed cabinet speakers are designed to work with damping factors from 9 to 20, some will not reach the point of smoothest bass until damping becomes quite low. The AR-1 Acoustic Suspension System (Fig. 1) has an optimum factor of one. What figure is best for a given system depends upon acoustic damping, maximum impedance variation, magnetic flux density, and all sorts of things. The *Hartley* speaker, for example, has an insignificant impedance peak in its "Boffle." Obviously, wide variations in damping factors will have little effect on its response.

Things become more interesting when we investigate the effects of variable damping on bass-reflex type

systems such as the *Jensen* "Bass Ultraflex" cabinet of Fig. 6. The family of curves for vented systems is shown in Fig. 4. The fly in the ointment here is that while impedance is still related to cone movement, the acoustic output of the system is not. Too low a damping factor will peak the response of the system about a half octave above vent resonance, giving a nice "thunky" effect. Running the source impedance into the $-Z$ region, however, has consequences even more weird. The upper impedance peak is "damped out" all right, but the main system resonance is completely out of control.

An interesting point in connection with these bass-reflex curves is that the $-Z$ system gives *more* audible bass than the constant current circuit. While for an enclosed cabinet speaker, a negative damping factor may effectively swamp out resonances, when used with a reflex system the chamber resonance is accentuated instead.

A horn-type system would be expected to have high acoustic damping and small variations in impedance. When this holds true, electrical damping has little to do with frequency response, as can be demonstrated experimentally. Commercial horns, however, employ acoustic resonance to extend their bass response below the horn cut-off frequency and this resonance is reflected in the impedance characteristics of the system. Fig. 5 is the *Jensen* "Imperial" which uses a "reactance annulling" principle to deliver usable bass below 35 cycles.

The *Klipsch*-type horns with enclosed back chambers have impedance curves similar to that of an infinite baffle and react somewhat the same way to variations in damping. Most of these large units are designed to work under conditions approximating constant voltage input. Paul Klipsch suggests a damping factor of 4 or more for his speakers, and reports that any attempt to use constant current feed, or negative damping factors, invariably deteriorates the performance of the system.

Smaller rear-loaded horns such as the *Klipsch* "Rebel" and *Electro-Voice* "Aristocrat" have impedance curves more akin to reflex cabinets. Unless the response of Figs. 4B and 4D are what you want, damping should be set at the figure recommended by the manufacturer.

In spite of the instructions furnished, many users try to adjust the damping control to the kind of bass response they happen to like. The illustrations given should explain why an audiophile with this philosophy is unlikely to find satisfaction. Moreover, the curves shown are merely representative and greatly simplified; the relationship between impedance and acoustic output for any given speaker may vary rather sickeningly from these graphs. Fig. 2 shows the impedance and frequency response of an actual system.

It must be remembered that the ordinary listener has no idea of the im-

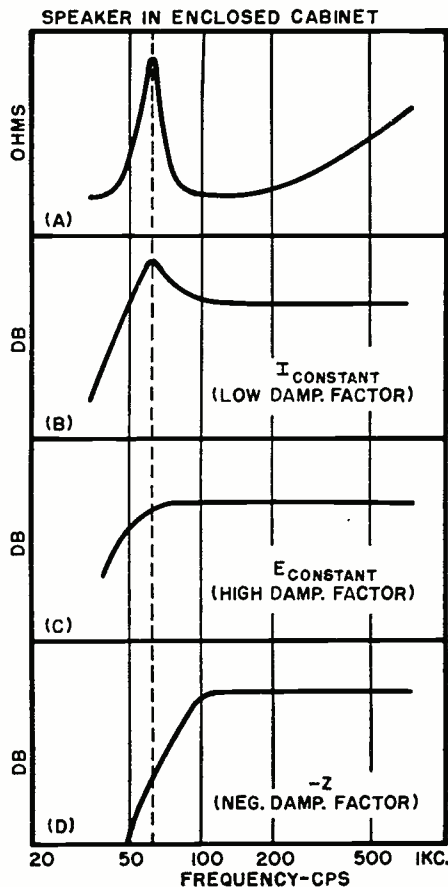

Fig. 3. (A) Impedance, (B) response with constant current, (C) constant voltage, and (D) negative impedance sources of signals.

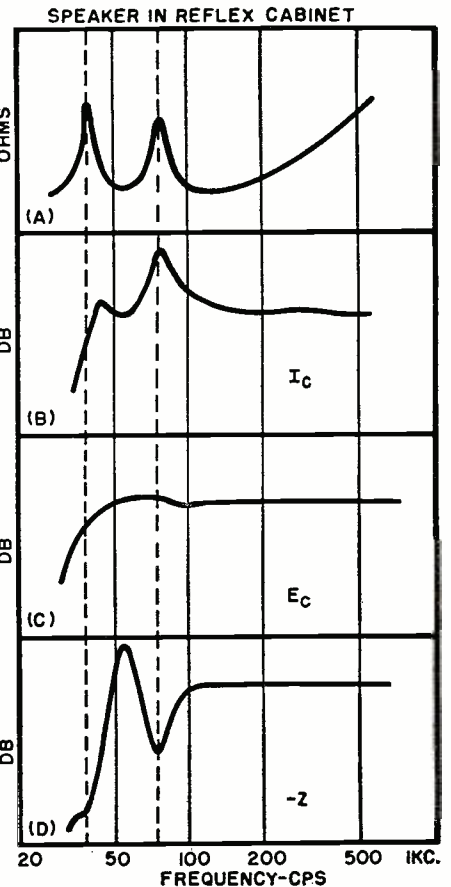

Fig. 4. Curves corresponding to Fig. 3 pertaining to speaker installed in a bass-reflex rather than completely closed cabinet.

pedance curve of his speaker system and has probably never looked closely at the instructions to see what damping factor is recommended. In this situation, it is no wonder he is confused by a damping control. Things haven't been helped by some salesmen who twist the control to minimum damping—"Hear that bass come out now?"—and mumble something about

the amplifier automatically adjusting to speaker impedance.

A variable damping control is valuable because different speakers do work better with different damping factors, but once the proper source impedance has been established, the damping control should be hidden and forgotten until the speaker system is changed.

Fig. 5. *Jensen* "Imperial" horn-type system uses "reactance annulling" for low bass.

Fig. 6. *Jensen* "Bass Ultraflex" speaker enclosure of the modified reflex type.

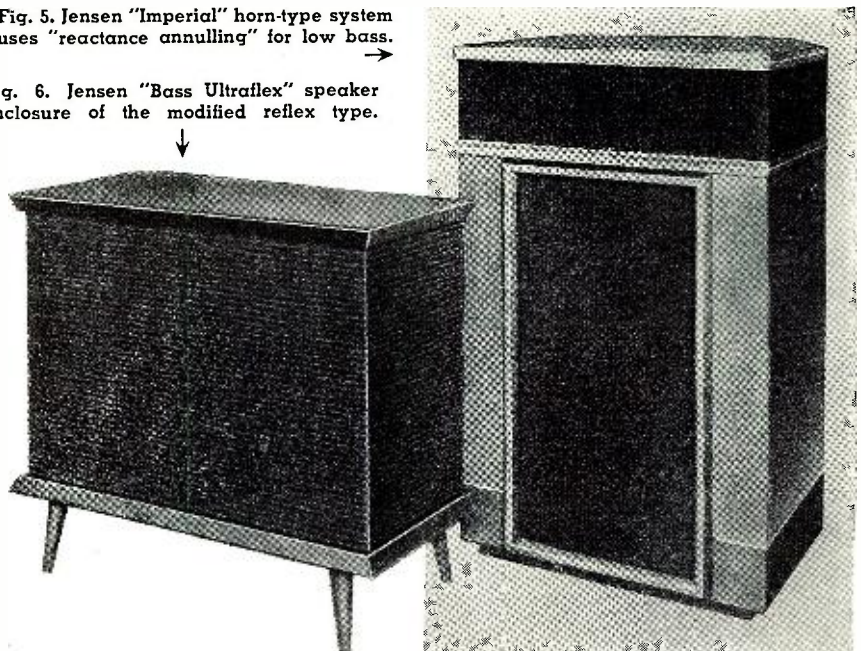

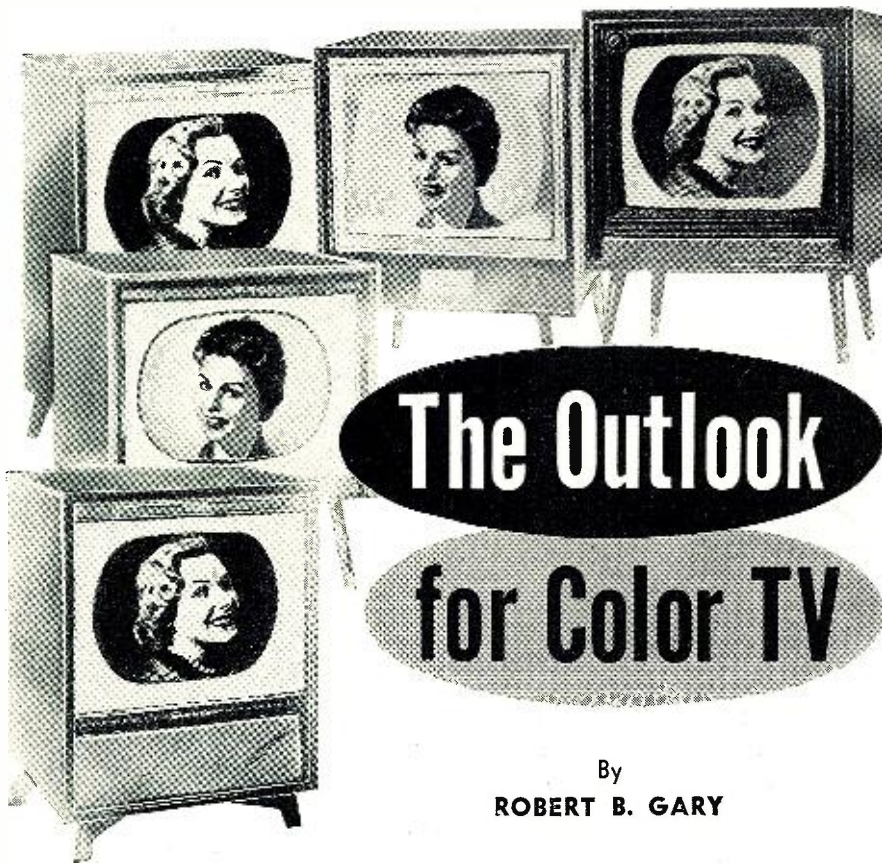

The Outlook for Color TV

By
ROBERT B. GARY

Pricing for the installment buyer is as much a factor as programming and technical improvement.

THERE can be no doubt that the tempo of color programming and receiver merchandising has been stepped up considerably during the latter part of 1956 and the beginning of 1957. A number of large manufacturers have placed competitive color sets on the market and have invested heavily in advertising, distribution, and servicing preparations. With at least five major manufacturers producing sets, color must succeed.

Sales Features

The most important single sales feature is, of course, the new low price. With the original announcement by *RCA* that it would offer a set for \$495 which could receive both color and black-and-white, a large segment of the market was made available. It had long been argued by retailers that a receiver with a \$500 maximum price could be sold on installments suitable for most middle-income families. The economic argument runs somewhat like this: The old TV set needs major repairs and is ripe for a trade-in. Granting a trade-in value of about \$50, and offering a year's guarantee for about \$100, the customer would have to put down only about \$100 to \$150 in cash and take a year to pay the remainder at low interest rates. In a typical transaction like this, the monthly payments for a one-year plan

amount to \$39.50. A two-year payment plan would cost only \$20.60 a month, or \$4.80 a week. This rate of payment is quite customary in the appliance and furniture fields and definitely brings the color TV set within the range of a very large segment of the buying public.

Monochrome TV started out with \$325 for the least expensive set—and this was at a time when minimum wages and average earnings were considerably lower than today. Another straw in the wind of the tinted TV future is the recent announcement by *Muntz* that it is operating and planning a \$395 color TV set.

The second most important sales feature is the ease of operation now designed into recent receivers. Earlier models contained a bewildering number of color adjustments, which prompted the frequent statement that color sets were only useful when sold together with the designing engineer. Now, however, most sets use only two color controls that require viewer adjustment, and these are often only fine settings for a coarse adjustment made by the installer. Adjusting the chroma gain control and the hue control is within the ability of most viewers and should not cause too many unnecessary service calls. Automatic switch-over from color to monochrome and many other circuit improvements add

to much easier customer adjustments.

As with the earlier monochrome receivers, it is expected that most new color sets will be sold with a year's service and installation contract. *RCA* and a few other manufacturers offer factory service in most areas. *Emerson*, to cite another example, offers factory service only in the New York metropolitan area and dealer servicing elsewhere. The majority of manufacturers still leave the installation and servicing up to their dealers and distributors, but offer the service personnel of these agencies extensive training, both at the factory and through field-service clinics, to acquaint them with the particular lines of color receivers.

Technical Features

In this respect the outstanding feature is the almost universal adoption of the 21-inch round metal-envelope shadow-mask picture tube, the 21AXP22. Several tube manufacturers now produce this CRT in quantity, and almost all new color sets use it. The exception is *Westinghouse*, which manufactures its own 22-inch, rectangular all-glass shadow-mask tube. The electrical characteristics of both tube types are so similar that there is practically no difference in the circuitry required to operate either tube.

The much publicized *Lawrence* tube still has not been used in production quantities, but *Du Mont* recently announced plans to manufacture this type of picture tube and eventually incorporate it in its color receivers.

Philco's beam indexing color picture tube, also known as the "Apple" tube, has been returned to the laboratory and has not yet re-appeared. The current *Philco* color receivers use the 21AXP22 shadow-mask tube.

Although no radically new circuits are used in the new color receivers, improvements can be seen both in circuit design and in production techniques. The increasingly wider application of printed-circuit techniques to all portions of color sets and the use of multiple-purpose tubes will reduce production costs as well as simplify assembly and servicing. Some of the new color receivers that use printed circuitry throughout provide a layout which really speeds up alignment and troubleshooting. Typical of these improvements are the new *Westinghouse*, *RCA*, and *Sylvania* sets which will permit removal of sufficient top, front, and side panels to permit real access to each portion of the chassis.

Installation is greatly simplified since most color receivers will be shipped with the picture tube in the cabinet. In several sets the picture tube is even mounted on the main chassis, which permits removal of the entire assembly. To further aid the service technician, test points are available on most chassis with suitable references in the service data. The availability of reasonably priced color test equipment is another step forward in the inevitable growth of color TV.

—30—

A 3-Channel Amplifier

By
KENNETH W. BETSH



Fig. 1. Over-all view of the three-channel high-fidelity power amplifier.

Designed for three-way speaker systems, this triple channel high-fidelity amplifier has variable electronic crossovers and provisions for electrostatic loudspeakers.

HERE is an amplifier, designed particularly for three-way speaker systems, that incorporates two popular innovations in the high-fidelity field. They are the use of "electronic" crossovers and electrostatic tweeters. The former amounts to resistance-capacitance crossover networks preceding individual amplifier channels for each speaker. Two crossovers are involved. The upper is fixed at 5000 cps while a choice of four—188, 375, 550, and 800 cps—is available for the lower crossover. The crossover switch also permits two-channel operation using the 5000 cps crossover and single-channel operation for conventional amplifier use.

The high-frequency channel of the amplifier was designed for two series-connected *Isophon* electrostatic speakers. Selling at a low price, information regarding these speakers may be had from *Arnhold Ceramics, Inc.*, 1 E. 57th St., New York 22, N. Y., the U. S. distributor.

Electrostatic speakers are not as easy to connect to a regular amplifier as one might wish. They are high-impedance devices, require d.c. polarizing voltage, and are limited to frequencies above 5000 cps. If a separate amplifier, limited to the high-frequency range, is used to drive these speakers, however, they may merely be connected between plate and ground. The output transformer, as a coupling device, is eliminated. This easily justifies an "electronic" crossover for separating electrostatic speaker output.

Reasons for using separate amplifiers for the low- and mid-range speakers in a three-way speaker system are quite different. First of all, there is the advantage of eliminating the conventional crossover network between the amplifier and speaker.

Such networks are physically large and usually expensive, especially when the crossover frequency is quite low. They interfere with speaker damping and transient response in the region of the crossover frequency. At best they are only approximate since the builder or purchaser seldom knows the exact speaker impedance at the crossover frequency. The resistance of the crossover coils constitutes a small power loss. Second, with separate amplifier channels, the problems of speakers with different impedances or efficiencies are eliminated. Since attenuation in the speaker or crossover circuit, such as with L-pads is not required, amplifiers for the more efficient speakers operate at a lower power and, therefore, lower distortion level. Last of all, there is the advantage for electronic crossovers in the case of changing the crossover frequency. It is only necessary to change four $\frac{1}{2}$ watt resistors.

The added cost of a separate amplifier channel to drive the mid-range speaker need not be great. With such a limited frequency range, an inexpensive output transformer and moderate output power will suffice. A common power supply further reduces the cost.

Individual Amplifier Channels

The high-frequency channel is designed especially for the operation of electrostatic speakers. Two of the speakers in series have an impedance

in the range of 7000 to 10,000 ohms. This is a good load for a 6AK6. The combination of a pentode with cathode degeneration plus some voltage feedback results in a fairly constant power output for varying load. This is desirable in that the speakers have a capacitive element whose impedance will vary with frequency. The primary winding of a small output transformer is used to supply plate voltage to the 6AK6. Since the signal is not coupled through the transformer, an inexpensive transformer of any impedance will be suitable.

Referring to the schematic, Fig. 2, the network of C_2 , C_3 , R_1 , and R_2 determines the frequency range over which the channel operates. The value of C_3 attenuates the low-frequency response but has negligible effect on the crossover characteristic. The cathode-follower is used to provide a low source-impedance to the crossover network.

In the range of 200 cps to 10 kc., the mid-range channel has a low distortion output of 8 watts and a maximum of 15 watts. A split plate-cathode phase inverter is used. Since balance of the push-pull stage is necessary for low distortion, a pot is placed in the cathode side of the inverter. Using an intermodulation analyzer, the author cut the low-level distortion in half by the use of this pot over that with fixed matched resistors. About 50,000 ohms of the pot is used. Either a linear 100,000 ohm or a 500,000 ohm

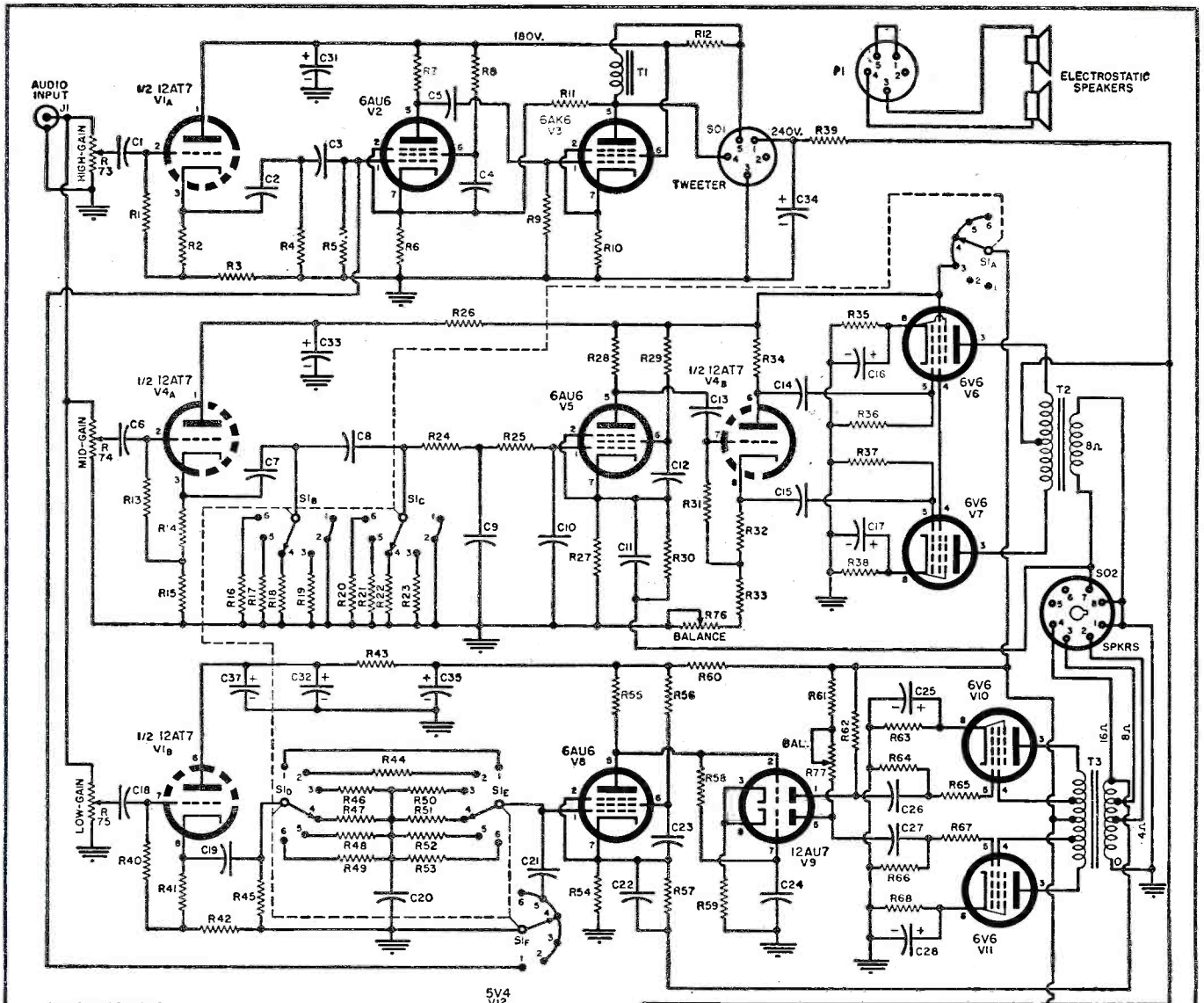

SWITCH POSITIONS

- 1 - SINGLE
 - 2 - DUAL
 - 3 - 188
 - 4 - 375
 - 5 - 550
 - 6 - 800
- TRIPLE

- R₁, R₉, R₁₃, R₃₁, R₄₀, R₄₅, R₆₁, R₆₆—470,000 ohm, 1/2 w. res.
- R₂, R₁₄, R₁₁—820 ohm, 1/2 w. res.
- R₃, R₁₅, R₁₂—56,000 ohm, 1 w. res.
- R₄, R₁₈, R₂₄, R₄₇, R₅₇—100,000 ohm, 1/2 w. res. 5%
- R₅, R₂₂, R₂₅, R₅₁—330,000 ohm, 1/2 w. res. ± 5%
- R₆, R₂₇, R₃₁—1500 ohm, 1/2 w. res.
- R₇, R₂₃, R₂₅—220,000 ohm, 1/2 w. res.
- R₈, R₂₉, R₃₀—560,000 ohm, 1/2 w. res.
- R₁₀—510 ohm, 1/2 w. res.
- R₁₁—8.2 megohm, 1/2 w. res.
- R₁₂—12,000 ohm, 1/2 w. res.
- R₁₆, R₁₉—47,000 ohm, 1/2 w. res. ± 5%
- R₁₇, R₃₀, R₃₂—68,000 ohm, 1/2 w. res. ± 5%
- R₁₈, R₁₉—200,000 ohm, 1/2 w. res. ± 5%
- R₂₀, R₃₃—150,000 ohm, 1/2 w. res. ± 5%
- R₂₁, R₃₂—220,000 ohm, 1/2 w. res. ± 5%
- R₂₃, R₃₀—680,000 ohm, 1/2 w. res. ± 5%
- R₂₄, R₁₃, R₃₉—22,000 ohm, 1/2 w. res.
- R₂₅—1200 ohm, 1/2 w. res.
- R₂₆, R₃₂—47,000 ohm, 1/2 w. res.
- R₂₇—100,000 ohm, 1/2 w. res.
- R₂₈, R₃₃, R₃₅—510 ohm, 2 w. res. ± 5%
- R₂₉, R₃₇—270,000 ohm, 1/2 w. res.
- R₃₀—2700 ohm, 2 w. res.
- R₃₄—43,000 ohm, 1/2 w. res. ± 5%
- R₃₅—1 megohm, 1/2 w. res.
- R₃₆, R₃₇—10,000 ohm, 1/2 w. res.
- R₃₈—33,000 ohm, 1/2 w. res.

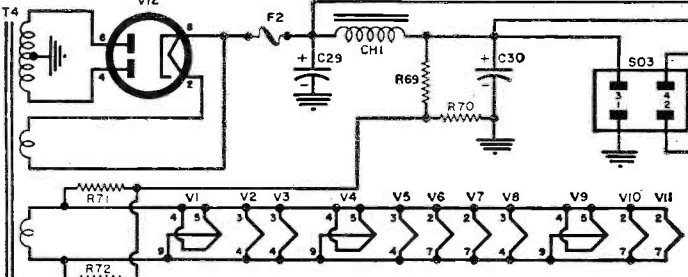

- R₆₃, R₆₅—1000 ohm, 1/2 w. res.
- R₆₉—100,000 ohm, 2 w. res.
- R₇₁, R₇₂—47 ohm, 1/2 w. res.
- R₇₃, R₇₄, R₇₅—2 megohm audio-taper pot
- R₇₆, R₇₇—100,000 ohm linear or 500,000 ohm audio-taper pots (see text)
- C₁, C₆—0.01 μfd., 200 v. capacitor
- C₂—600 μfd. mica capacitor ± 5%
- C₃—180 μfd. mica capacitor ± 5%
- C₄, C₁₃, C₁₄, C₁₅—0.1 μfd., 400 v. capacitor
- C₅—0.01 μfd., 400 v. capacitor
- C₇—8600 μfd. mica capacitor ± 5%
- C₈—2600 μfd. mica capacitor ± 5%
- C₉—170 μfd. mica capacitor ± 5%
- C₁₀—51 μfd. mica capacitor ± 5%
- C₁₁—100 μfd. mica capacitor ± 5%
- C₁₂—0.5 μfd., 400 v. capacitor
- C₁₆, C₁₇—10 μfd., 50 v. elec. capacitor
- C₁₈—0.2 μfd., 200 v. capacitor
- C₁₉—1 μfd., 200 v. capacitor
- C₂₀—2400 μfd. mica capacitor ± 5%
- C₂₁—730 μfd. mica capacitor ± 5%
- C₂₂—47 μfd. mica capacitor ± 10%
- C₂₃, C₂₄—22 μfd., 400 v. capacitor
- C₂₅, C₂₈—50 μfd., 50 v. elec. capacitor

- C₂₆, C₂₇, C₂₈—0.5 μfd., 600 v. capacitor
- C₂₉—C₃₀, C₃₁—C₃₅—40/40 μfd., 450 v. elec. capacitor (upright can type)
- C₃₁—C₃₂—C₃₃—C₃₇—10/10/10/10 μfd., 450 v. elec. capacitor (upright can type)
- CH₁—100 ma. choke
- J₁—Phono jack
- S₁—6-pos., 6-pole shorting-type rotary switch
- F₁—3 amp. fuse
- F₂—1/2 amp. fuse
- SO₁—5-pin tube socket
- SO₂—Octal tube socket
- SO₃—4-pin socket
- P₁—5-pin plug
- T₁—Any single-ended output trans. (see text)
- T₂—Output trans., 8 watts, 10,000 ohms to 8 ohms
- T₃—Output trans. "Ultra-Linear" type for 6V6 tubes (Acro or Dyna)
- T₄—Power trans. 600 or 650 v. @ 175 ma.; 5 v. @ 2 amps.; 6.3 v. @ 4 amps. (min.)
- V₁, V₃—12AT7 tube
- V₂, V₅, V₈—6AU6 tube
- V₄—6AK6 tube
- V₆, V₇, V₁₀, V₁₁—6V6 tube
- V₉—12AU7 tube
- V₁₂—5V4 tube

audio taper pot gives this at half rotation (providing the counterclockwise end of the 500,000 ohm pot is used). Separate cathode resistors for the output tubes reduce unbalanced d. c. flow in the output transformer when tubes of unequal emission are used. Here again, the values of C_6 , C_{12} , C_{13} , C_{14} , and C_{15} restrict low-frequency response. If this channel is to be used much below 150 cps, the values of these capacitors should be increased. Two dual RC crossover networks, one each for lower and upper limits, are placed between a cathode-follower and a 6AU6 amplifier. The mid-range channel has 8 db of feedback coupled through R_{30} . This resistor is bypassed by C_{13} to control ringing. The intermodulation was measured using test frequencies of 250 and 6000 cps and found to be 1% at 1 watt and 5.3% at 5 watts.

The low-frequency channel is, other than for the crossover network, capable of full audio range operation. For added gain, a 12AU7 amplifier-phase inverter is used. It offers low distortion and a stage gain of about 5. A balancing pot is also used in this channel. The output stage is of the "Ultra-Linear" type using 6V6's. Again, separate cathode resistors are used. About 12 db of feedback is employed. Using test frequencies of 60 and 6000 cps, mixed 4 to 1, the intermodulation measured .6% at 5 watts and 4.5% at 8 watts.

Crossover Networks

Crossover networks with a 12 db per octave slope are widely used and accepted. With "electronic" crossovers a network of two resistors and two capacitors, such as shown in Fig. 3B, will produce a characteristic that in a couple of octaves reaches a 12 db per octave slope.

The characteristic of a single RC network, such as shown in Fig. 3A, is curve A in Fig. 5. Note that there is 3 db attenuation at the frequency F . This is the frequency where the reactance of the capacitor equals the resistance of R . At each crossover frequency of the amplifier, the response of each channel should be 3 db down. This is because, by definition, the 3 db point is the half-power or 70 per-cent of maximum voltage point.

This characteristic curve is based on the use of constant input voltage to the network and no load. With networks using resistances in the 25,000-ohm to one-megohm region, cathode followers can meet these conditions satisfactorily. If a cathode follower were connected between two identical RC networks, a characteristic as shown by curve B in Fig. 5 is obtained. This curve shows twice the attenuation of curve A, and is, therefore, 6 db down at F . The 3 db point, by calculation, occurs at $.63F$. If the values of the capacitors are multiplied by $.63$, the curve is shifted to the right, as in

CROSSOVER FREQ.	C_7	C_8 (Capacity in $\mu\text{fd.}$)	C_{20}	C_{21}
200	15,015	4550	4211	1276
350	8580	2600	2400	729
400	7510	2275	2110	638
500	6000	1820	1650	510
600	5000	1520	1400	425
800	3750	1140	1050	320
1000	3000	910	825	255

Table 1. Calculated values of capacitors for various fixed crossover frequencies.

curve C, so that the 3 db point is at F . This allows accurate comparison of the two characteristics.

If two RC sections are directly joined without the cathode-follower between, the characteristic curve (if moved to the right to place the 3 db point at F) will fall between curve A and curve C, depending on the ratio of the impedance of the second section to the first. Calculations were made for the ratios of 1, 2, 3.3, 5, and 10. The characteristic for the ratio of 1, where R_{16} equals R_{20} and C_{20} equals C_{21} , is shown as curve D. The ratio of 3.3 is shown as curve E. Since it is only about 2 db away from the ideal and since higher ratios introduce other problems, this ratio is used in the calculations for the crossover networks of this amplifier. For this ratio, the 3 db point is at $.53$ of the frequency where X_c equals R . For a low-pass network, calculations must be made on the basis of X_c equals R at the crossover frequency divided by $.53$, or in other words, at 1.89 times the crossover frequency.

The low-pass network of Fig. 3B is the crossover network of the low-frequency channel. Ideally, the resistors should be fixed and the capacitors varied to change the crossover frequency. Over the limited range involved in this amplifier, 188 to 800 cps, the capacitor may be held fixed and the resistance varied. A frequency of 375 cps is taken as a median point and values for the capacitors are deter-

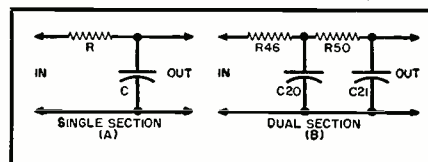

Fig. 3. RC low-pass networks. See text.

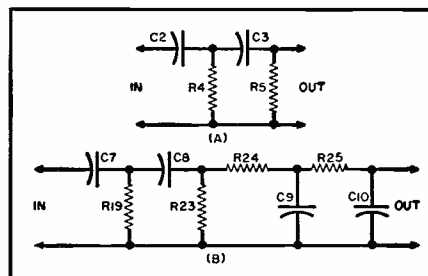

Fig. 4. (A) RC high-pass network. (B) Combined high- and low-pass networks.

mined for the best resistance values, which are set at 100,000 and 330,000 ohms for R_{46} and R_{50} , respectively. To change the crossover frequency, other resistors ranging from about one-half to twice these values are switched in. In the schematic, C_{10} and R_{45} , which precede the low-pass network, are used to provide d.c. isolation and a grid return.

For the high-frequency channel, a high-pass network, as shown in Fig. 4A, is necessary. Its characteristic is the reverse of curve E and is shown as curve F in Fig. 5. The 3 db point

Fig. 5. Frequency response curves for circuits with various RC networks.

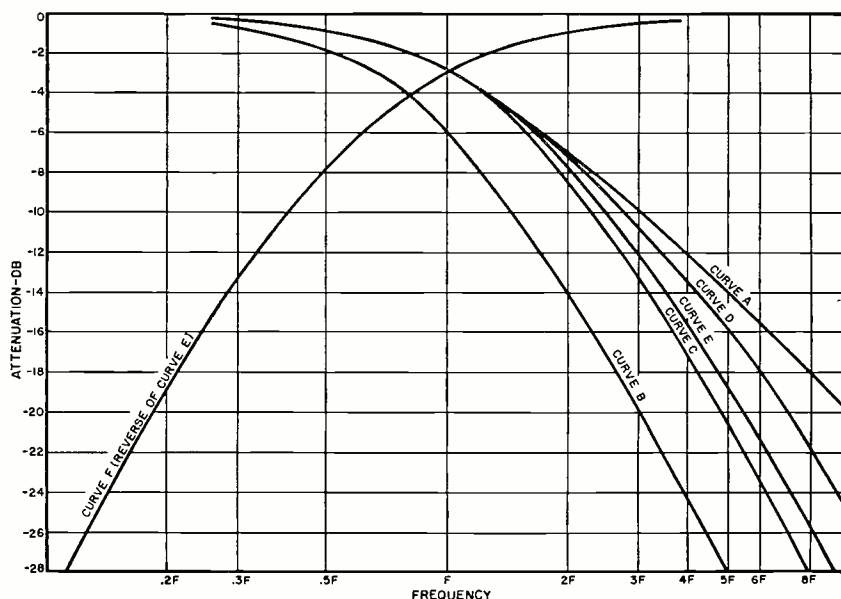

Fig. 2. Complete schematic diagram of three-channel audio power amplifier.

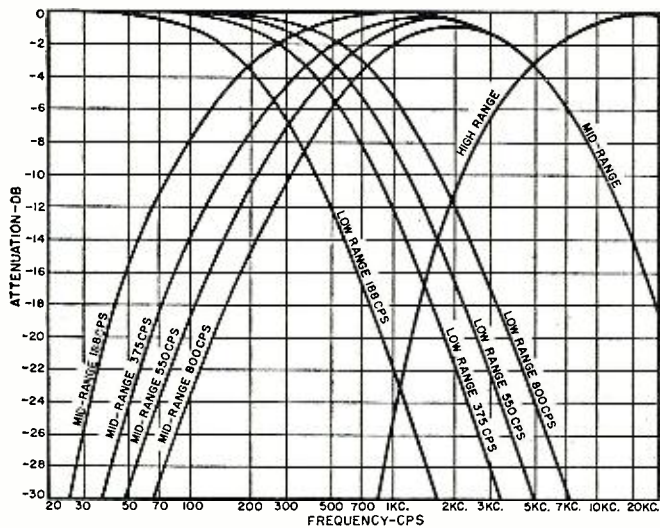

Fig. 6. Measured frequency response curves of three-channel amplifier.

occurs at 1.89 times the frequency where X_c equals R . Therefore, for a crossover at 5000 cps, calculations must be made on the basis of X_c equals R at 5000/1.89 or 2646 cps. Using resistances of 100,000 and 330,000 ohms for R_4 and R_5 , the capacitors C_2 and C_3 are 600 $\mu\text{fd.}$ and 180 $\mu\text{fd.}$

For the mid-range channel both low-pass and high-pass networks are necessary. To prevent a fixed loss the high-pass network precedes the low-pass network. The resultant network is shown in Fig. 4B. The resistors are the same as those in the corresponding networks in the other channels. From the foregoing discussion showing the frequency where X_c equals R at either 1.89 or .53 times the crossover frequency, depending on whether it is a low-pass or high-pass network, one finds the capacitor values will be quite different for corresponding networks

even though equal resistances are used. The second half of Fig. 4B is a low-pass network for the 5000 cps crossover. Using resistances of 100,000 and 330,000 ohms, capacitor values are 170 and 51 $\mu\text{fd.}$ For the first half, the high-pass network of the lower crossover, identical resistor values to those used in the low-frequency channel are used. Capacitor values for C_7 and C_8 are 8600 and 2600 $\mu\text{fd.}$

For two-channel operation the selector switch disables the mid-frequency channel and allows the low-frequency channel to operate up to 5000 cps. This circuit becomes a single-section RC network. This is for the sake of simplicity and cannot be considered serious since the efficiency of cone speakers at high-frequencies drops off when operated from a nearly constant voltage source such as the output of the low-frequency channel. For single-

channel use, the low-pass network is disconnected and the other two channels disabled. The "B-plus" drain of the high-frequency channel can be removed by disconnecting the tweeter plug. Pins 1 and 5 are shorted on the plug.

Naturally, for exact crossover frequencies, the resistors and capacitors used in the networks must be accurate. It is not so important that the crossover frequency be exactly as desired. Rather, the component accuracy is important so that corresponding high- and low-pass networks will have 3 db points at the same frequency. Resistors with a 5% tolerance are satisfactory, particularly if all are of one brand and obtained at one time and place. A batch of resistors manufactured at the same time are almost always very close to each other in resistance. For maximum stability, mica capacitors should be used. Hand picking and measuring is most desirable. Otherwise, 5% tolerance capacitors should be used. In some cases it will be necessary to parallel standard values to obtain the proper value.

If the amplifier is to be used with a speaker system that is not subject to change, the selector switch can be eliminated and fixed values used. The resistances shown for a 375 cps crossover, namely, 100,000 and 330,000 ohms, can be wired in directly and capacitors, as listed in Table 1, used for other frequencies. These are calculated values. For best results the capacitors should be within five percent of these values. For a higher crossover, the use of fixed frequencies has the advantage of permitting the use of physically smaller capacitors.

The frequency response of each channel was measured and is shown in the response curves of Fig. 6. The low- and mid-range channels were measured with resistive loads at a level of 5 watts. The high-frequency channel output was measured across a 100-ohm resistor connected between the low side of the speakers and ground. Thus, the measurement was with the electrostatic speakers connected.

The amplifier is constructed on a 10" x 12" aluminum chassis. Small brackets were made to hold the balancing pots beneath the chassis. An under-chassis view of the amplifier is shown in Fig. 7. After mounting the transformers and upright electrolytics, a touch of "class" can be achieved by spraying the chassis with one of the new pressure-can sprays.

If an intermodulation distortion meter is available, adjust the balance pots for minimum distortion at about a one watt level. Those without distortion meters may adjust the pots for equal a.c. signals at the plates of the 6V6's. If no measuring equipment is available, the balancing pots may be eliminated with these two changes: R_{33} and R_{31} , both 100,000 ohms plus or minus 5%, and R_{61} is 56,000 ohms.

No power switch or master gain
(Continued on page 133)

Fig. 7. Under-chassis view of the completed three-channel audio power amplifier.

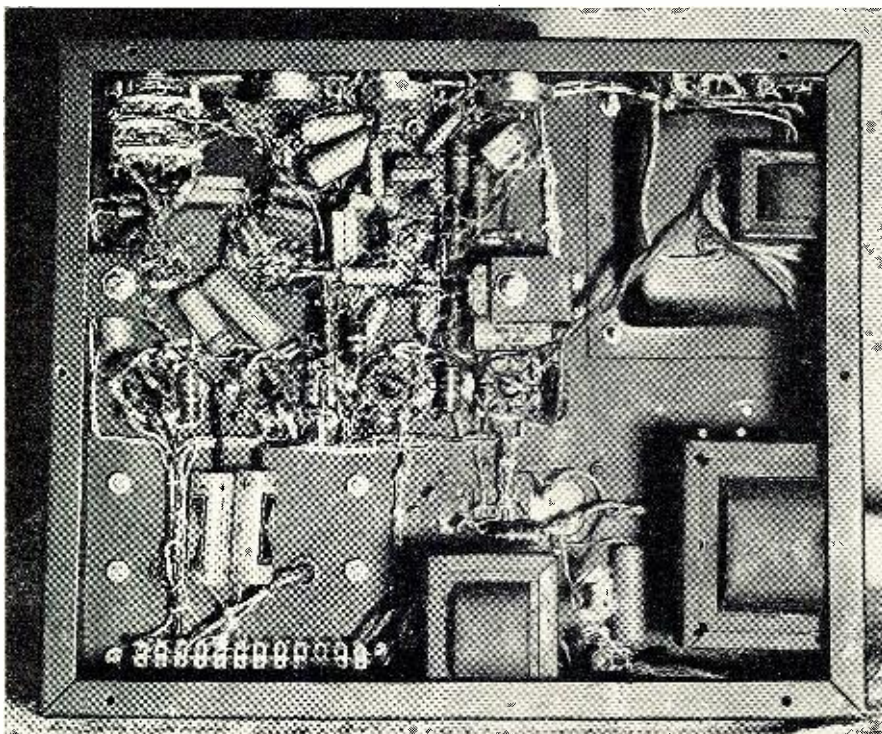

More Jobs for the A.C. V.T.V.M.

By RUFUS P. TURNER

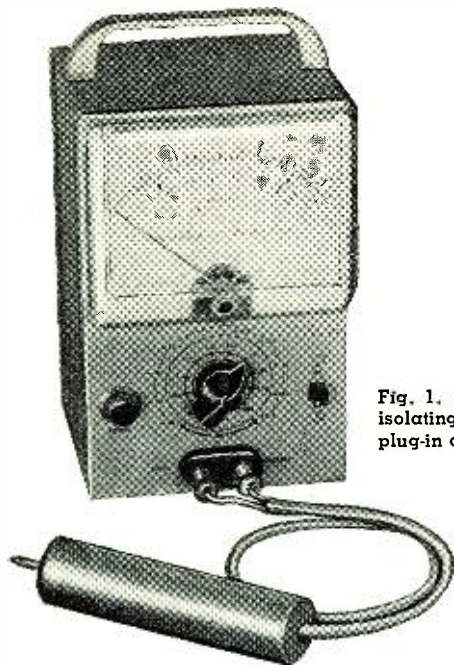

Fig. 1. An a.c. v.t.v.m. with a shielded isolating probe added, as well as a plug-in current-reading shunt (lower right).

Increase its voltage range or input impedance; use it as an a.c. ammeter; check unknown impedances.

HERE is no doubt that the a.c. vacuum-tube voltmeter is a very useful instrument. Formerly referred to as an audio v.t.v.m., this instrument is a millivoltmeter as well as voltmeter. Various well-known models commonly cover full-scale ranges extending from 1, 3, or 10 millivolts to 100 or 300 volts. The presence of these low-voltage ranges enables sensitive measurements such as gain checks; null detection; also hum, noise, and distortion tests not possible with general-purpose vacuum-tube voltmeters or with many oscilloscopes. The appearance several years ago of the kit-type a.c. v.t.v.m. brought sensitive measurements within the province of serious audio hobbyists and low-budget laboratories, as well as increased numbers of service technicians.

After gaining familiarity with the instrument, the alert technician looks for ways to increase its usefulness. This article describes several simple schemes for so increasing the utility of many such instruments, such as Heathkit models AV-1 and AV-2.

Raising Input Impedance

The input impedance of models AV-1 and AV-2 is 1 megohm, as it is with many comparable instruments. While this value is entirely adequate in most applications, there are occasions when a higher input impedance is desirable. The simplest way to boost the impedance is to add external resistance in series with the "hot" input terminal, as shown in Fig. 2A. The external component can be a small resistor installed in the nose of a shielded test probe like the one shown connected to the meter in Fig. 1.

Voltage-divider action between the

external resistance and the 1-megohm input resistance in the meter will, of course, modify all readings of the meter. Thus, the addition of a 1-megohm external resistance, while it raises the input resistance of the v.t.v.m. to 2 megohms, also will *halve* all of the voltage readings. (Example: 10 volts input gives a 5-volt deflection.) Table 1 has been prepared to free the reader from the necessity of performing calculations in this connection with a wide range of impedances. It shows the new input impedance obtained by connecting various standard values of external resistance, and the scale multiplier which must be used as a result in each case.

Isolating the Input Circuit

In many models of the a.c. v.t.v.m., the range selector is a string of voltage-dividing resistors connected directly across the input terminals of the instrument. When a signal voltage is measured between a circuit point and ground, and a d.c. component of voltage also is present (as when checking the signal level at the plate of a tube), this 1-megohm resistance string can, in some instances, divide the d.c. voltage and accordingly modify operation

Fig. 2. Resistor added (A) to increase impedance. When meter's internal resistance (B) puts d.c. load on circuit under test, use an isolating capacitor (C).

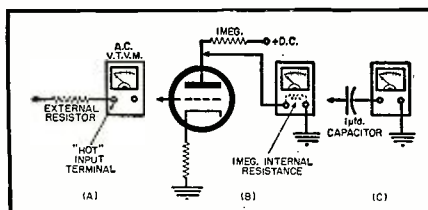

EXTERNAL RESISTANCE IN SERIES WITH METER (1 watt, precision)	COMBINED INPUT IMPEDANCE	MULTIPLY ALL SCALE VOLTAGE READINGS BY
1 megohm	2 megohms	2
2 "	3 "	3
3 "	4 "	4
4 "	5 "	5
*9 "	10 "	10
**19 "	20 "	20
*4 and 5 megohms in series		
**1 and 18 megohms in series		

Table 1. Multiplying factor for scale readings with various values of external resistance used with the v.t.v.m.

of the circuit under test. Fig. 2B illustrates this condition. Here, the plate load resistor is 1 megohm. The v.t.v.m. resistance of 1 megohm is between plate and ground. Thus, a 2:1 voltage divider is formed. At low plate-current levels, this can result in a halving of the d.c. plate voltage.

The obvious remedy, shown in Fig. 2C, is to connect an external capacitor in series with the hot input terminal. A high-quality 1- μ fd. capacitor is suitable. The frequency response of the voltmeter is affected only slightly by this capacitor. At the upper-frequency limit of the v.t.v.m., which may be about 50 kc. or more, the reactance of this component is approximately 3.2 ohms. At the lower-frequency limit (probably near 10 cps), reactance is approximately 16,000 ohms. Thus, inclusion of the capacitor introduces only a 1.6 per-cent error at 10 cycles, 0.3 per-cent at 60 cycles, and a negligible error at 50 kc. If desired, the 1- μ fd. capacitor may be enclosed in a probe, to be used only when isolation is required, like the one shown in Fig. 1.

Voltage Multiplication

The highest range of the a.c. v.t.v.m. may be only 300 volts. This is also the +50 db range. Another range, which would be 1000 volts (+60 db) is often useful. The 100-volt range can be quickly converted to a 1000-volt range simply by connecting an external 9-megohm, 1-watt, precision resistor to the hot input terminal. The 9-megohm unit, which can be made up of 4- and 5-megohm standard resistors connected in series, may be enclosed in a high-voltage-type test probe. Connections

(Continued on page 146)



By JOHN T. FRYE

"TENNESSEE VALLEY INDIANS"

IN SPITE of the fact that the door of Mac's Service Shop was equipped with an automatic door closer, Barney had to push it shut against the buffeting, roaring wind that held it open this boisterous March morning. "Whew, what a day!" he exclaimed to Mac, his employer, as he entered the service department and set the TV field strength meter he was carrying on the bench. "We'll get some antenna jobs out of this or I'll miss my guess badly."

"Looks as though you've been checking your antenna already," Mac remarked with a nod at the field strength meter.

"Then looks are deceiving," Barney retorted with a grin. "I've been using the meter to chase Tennessee Valley Indians."

"That's what we hams call television interference connected in any way with an amateur station," Barney went on in answer to Mac's questioning look. "While we are experimenting and working to eliminate it, the descriptive phrase is calculated to be more soothing and less significant to the ears of an irate TV viewer than 'TVI,' which he has already figured out stands for 'television interference.'"

"How do you use the meter?"

"As a very sensitive detector of harmonics from the transmitter that causes trouble. A small loop on the end of a short piece of twin-lead feeds through a high-pass filter into the antenna terminals of the meter. The filter keeps the fundamental of the transmitter from getting into the meter; but TVI—causing harmonics from a properly placed transmitter frequency will give a substantial reading even though they are very weak."

"What do you mean by a 'properly placed transmitter frequency?'"

"Well, this meter tunes to the sound carriers of the TV stations, and the fine-tuning permits going only a short way each side of the carrier. That means the amateur transmitter should be set so that the harmonic being

investigated will fall squarely on the audio carrier of the channel having interference. For example, when I operate ten meters I get TVI on channel 6. That means I should set my transmitter on 29.25 megacycles so that the third harmonic falls squarely on 87.75 megacycles, the sound carrier of channel 6, to insure any harmonic present will give a maximum reading on the field strength meter."

"Did you find a harmonic from your transmitter?"

"Yes. While it has a strength of only a few microvolts, that is enough to do the dirty work in this fringe area where the average signal strength from the station on channel 6 is around one hundred microvolts. In his book *Television Interference*, Phil Rand of *Remington Rand* comments that cross-hatching is not produced unless the interfering signal is at least 1/100 as strong as the TV signal; but that means that in this area cross-hatching could start when my harmonic had a strength of only a microvolt per meter or so! We both know we can pick up the second and third harmonic of the local broadcast station here, even though the transmitting antenna is a couple of miles away. But if I am to keep from causing TVI, I must reduce my harmonics far below the strength of the received broadcast harmonics; and I must do this when the receivers are located within a literal stone's throw of my transmitting antenna. And I might add that since I am running about half as much power as the 250 watt broadcast station, the comparison is not unfair."

"You do have a nasty problem," Mac agreed. "I assume you are not alone."

"By no means. Hams who live in areas where the TV signals have strengths of several thousand microvolts and those who live where only u.h.f. stations are received, usually get by pretty well; but most of the rest of us have our problems. What's more, the whole problem is likely to grow

more acute for the next several months."

"Why?"

"Because the very favorable conditions on the higher frequency ham bands produced by the peaking of the sunspot cycle are attracting hams to the six-, ten-, and fifteen-meter bands in greatly increasing numbers."

"Is it easier to produce TVI when operating these bands?"

"Generally speaking, yes; although each of these bands causes trouble for a different reason. The six-meter band from 50 to 54 megacycles is right next door to the low-frequency TV channels and is almost certain to put some signal into the wide-open front end of a TV set. The ten-meter band, from 28 to 29.7 megacycles, is situated just right for its second harmonic to fall into channel 2 and its third harmonic to fall into channel 6. The fifteen-meter band, from 21 to 21.45 megacycles, is likely to put a signal straight into the i.f. system of an older set with an i.f. system around 21 megacycles; and of course the third harmonic of this band falls on channel 3 and the fourth harmonic on channel 6."

"Does an amateur station usually interfere with the picture, the sound, or both?"

"That depends on how the interfering signal gets into the set and the nature of the set itself. When the trouble is caused by harmonics of the transmitter signal, a split-sound-and-picture i.f. set will be more likely to have trouble with the picture than with the sound, since the harmonic is much more likely to fall somewhere in the broad picture channel than it is on the comparatively narrow audio channel. With intercarrier sets, however, where the sound is produced by beating the picture and sound carriers together, anything that affects the picture channel is reflected in the sound; so these sets usually have interference with both picture and sound. In some cases the signal from the transmitter will overload an unshielded audio stage and cause interference only with the sound. TVI can take a lot of puzzling and exasperating forms."

"Looking at the problem from the point of view of the service technician, what should he do when he runs into a case of amateur-produced TVI?"

"Above all, don't encourage the set owner to believe the trouble is all the amateur's fault. It may or may not be; and anyway the set owner seldom needs encouragement along that line of thought! Keep an open mind while you work on the problem. Second, contact the amateur and secure his cooperation. He is almost certain to be glad to work with you. He will have to operate his transmitter to check the result of various corrective measures, anyway; and you may easily find him a gold mine of practical information on reducing TVI. Just as the

(Continued on page 124)

Sun	Mon	Tue	Wed	Thu	Fri	Sat
		1	2	3	4	5
					12	
					19	
					26	

CALENDAR of EVENTS

MARCH 11-14

Second Annual Nuclear Science and Engineering Congress. Sponsored by the Engineers Joint Council. Convention Hall, Philadelphia. Contact Dr. Sidney Krasik, 5621 Wilkins Ave., Pittsburgh 17, Pa., for further information on program.

MARCH 11-15

International Atomic Exposition. 304 Architects Bldg., Philadelphia 3, Pa.

MARCH 18-21

National Convention of the Institute of Radio Engineers. Sponsored by the IRE. Waldorf-Astoria Hotel and the New York Coliseum, New York City. Ben Warriner, IRE, 1 East 79th St., New York, N. Y., is chairman of the 1957 convention.

Gas Turbine Power Conference. Sponsored by the American Society of Mechanical Engineers. Sheraton-Cadillac Hotel, Detroit. Contact L. S. Dennegar of the ASME at 29 W. 39th St., New York 18, N. Y., for additional details.

First Military Automation Exposition. Sponsored by Richard Rimbach Associates. New York Trade Show Building, New York City. Write the sponsors at 845 Ridge Ave., Pittsburgh 12, Pa., for additional details.

MARCH 27-29

Nineteenth Annual American Power Conference. Sponsored by the Illinois Institute of Technology and 14 universities and 9 national and regional technical societies. Illinois Institute of Technology, Technology Center, Chicago 16, Ill. Further details from E. R. Whitehead, secretary, Illinois Institute of Technology, 3300 Federal St., Chicago 16, Ill.

MARCH 27-28

Engineering Management Conference. Sponsored by the American Society of Mechanical Engineers. William Penn Hotel, Pittsburgh. Contact L. S. Dennegar of the ASME at 29 W. 39th St., New York 18, N. Y., for more details.

For information on scheduled Service Association Meetings, see "Service Industry News," page 160.

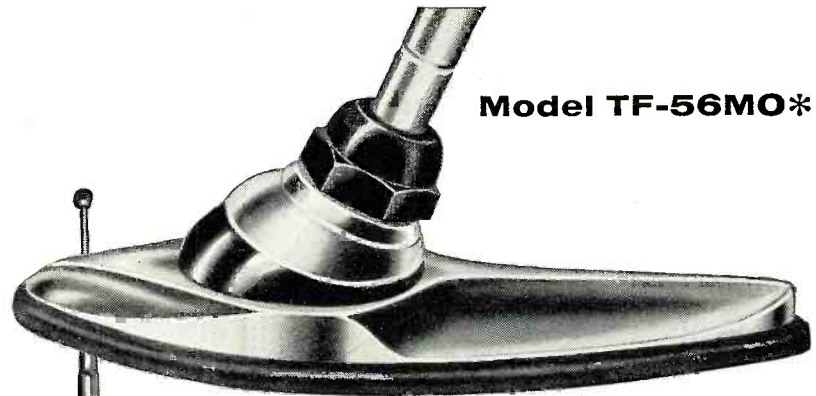

Model TF-56MO*

Ward Tear Drop Mount

... the replacement antenna
with original equipment styling

Here's the fast-selling style leader of them all... a new antenna designed for new car styling. Looks like the original equipment models, and combines smart appearance with finest reception!

- ★ Easy, quick installation
- ★ Mounts completely from outside of car
- ★ Angle adjustment to 35° in all positions
- ★ 3 sections extend to 56" from 22"
- ★ Heavy chrome plating throughout
- ★ 54" lead-in

Order your WARD Tear Drop Mounts today. Replace old antennas with these finest, newest models with that sales-appealing original equipment look. Write now:

* This model fits newest 1957 cars as is. For Ford, order Adapter Pad No. C-62 available in bulk.

LIST PRICE \$4.28
Individual Shipping Wt. 1-lb.

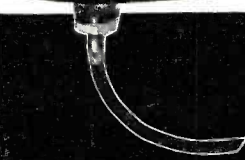

Ward PRODUCTS CORP.

DIV. OF THE GABRIEL COMPANY

1148 EUCLID AVE. • CLEVELAND 15, OHIO

IN CANADA, ATLAS RADIO CORPORATION - 50 WINGOLD AVE - TORONTO, ONTARIO

New



MODEL O-11

Shpg. Wt.
21 Lbs.

\$69⁵⁰

- * An improved model of what was already an outstanding instrument.
- * Performance is unmatched in this price range.
- * Incorporates the extra features required for color TV servicing.

Extra!

A FULL YEAR TO PAY

SEND FOR DETAILS OF HEATH
TIME-PAYMENT PLAN.

**5
BIG
REASONS
WHY**



**HEATH
COMPANY**

A SUBSIDIARY OF DAYSTROM, INC.

BENTON HARBOR 15, MICH.

HEATHKIT ETCHED CIRCUIT, PUSH-PULL

5" Oscilloscope Kit COLOR TV

The previous Heathkit oscilloscope (Model O-10) which was already a most remarkable instrument, has been improved even further with the release of the Heathkit Model O-11. It incorporates all the outstanding features of the preceding model, *plus* improved vertical linearity, better sync stability, especially at low frequencies, and much-improved over-all stability of operation, including less vertical bounce with changes in level. These improvements in the Model O-11 circuit make it even more ideally suited for color TV servicing, and for critical observations in the electronic laboratory. Vertical response extends from 2 CPS to 5 MC without extra switching. Response only down 2.2' DB at 3.58 MC. The 11-tube circuit features a 5UP1 cathode-ray tube. Sync circuit functions effectively from 20 CPS to better than 500 kc in five steps. Modern etched circuit boards employed in the oscilloscope circuit cut assembly time almost in half, permit a level of circuit stability never before achieved in an oscilloscope of this type, and insure against errors in assembly. Both vertical and horizontal output amplifiers are push-pull. Built-in peak-to-peak calibrating source — step-attenuated input — plastic molded capacitors and top-quality parts throughout — pre-formed and cabled wiring harness — and numerous other "extra" features. A professional instrument for the serveshop or laboratory. Compare its specifications with those of scopes selling in much higher price brackets. You can't beat it!

1 FEWER DOLLARS BRING MORE REAL QUALITY.

- Factory-to-you sales eliminate extra profit margin.
- "Build-it-yourself" eliminates labor charge.
- Heath purchasing power cuts component costs.

2 PERSONAL SERVICE ASSURES CUSTOMER SATISFACTION.

- You deal directly with the manufacturer.
- We are interested in you before and after sale.

Heathkits®

ARE YOUR BEST BUY...

3 PROVEN DESIGNS MEAN RELIABLE PERFORMANCE.

- Research and development efforts concentrated on kits only.
- All kits guaranteed to meet advertised specifications.

4 EVERY KIT BACKED BY WORLD-WIDE REPUTATION.

- The world's largest manufacturer of electronic equipment in kit form.
- Producer of more than a million electronic kits for the home workshop and industry.

5 EASY TIME-PAYMENT PLAN TO FIT YOUR BUDGET.

New HEATHKIT ETCHED CIRCUIT 5" Oscilloscope Kit

GREATEST SELECTION . . .

Whether your particular special interest is in servicing, ham-radio, high-fidelity, or just experimenting—there are Heathkits to fill your needs. You can equip an entire service shop or lab, buy a complete ham station or high-fidelity system, or set up a really deluxe home workshop, by choosing from the more than 70 different "do-it-yourself" electronic kits by Heath. Just glance through the kits displayed in this ad, and you will get some idea of the tremendous array of low-priced, high-quality electronic equipment available.

This new and improved oscilloscope retains all the outstanding features of the preceding model, but provides wider vertical frequency response, extended sweep-generator coverage, and increased stability. A new tube complement and improvements in the circuit make these new features possible. Vertical frequency response is essentially flat to over 1 mc, and down only 1½ DB at 500 kc. The sweep generator multivibrator functions reliably from 30 to 200,000 CPS, almost twice the coverage provided by the previous model. Deflection amplifiers are push-pull, and modern etched circuits are employed in critical parts of the design. A 5BP1 cathode-ray tube is used. The scope features external or internal sweep and sync, one volt peak-to-peak reference voltage, 3-position step-attenuated input, adjustable spot-shape control, and many other "extras" not expected at this price level. A calibrated grid screen is also provided for the face of the CRT, allowing more precise observation of wave shapes displayed. The new Model OM-2 is designed for general application wherever a reliable instrument with good response characteristics may be required. Complete step-by-step instructions and large pictorial diagrams assure easy assembly.

- * Brand new model with improved performance specifications.
- * Full 5" scope for service work at a remarkably low price.
- * Attractively styled front panel in charcoal gray with sharp white lettering.
- * Easy to build from step-by-step instructions and large pictorials. Not necessary to read schematic.



MODEL OM-2

\$42.50

Shpg. Wt.
21 Lbs.

HEATHKIT LOW CAPACITY PROBE KIT

Oscilloscope investigation of high frequency, high impedance, or broad bandwidth circuits encountered in television requires the use of a low-capacity probe to prevent loss of gain, circuit loading, or waveform distortion. The Heathkit low-capacity probe may be used with your oscilloscope to eliminate these effects. It features a variable capacitor, to provide correct instrument impedance match. Also, the ratio of attenuation can be varied.

No. 342

\$3.50

Shpg. Wt. 1 Lb.

HEATHKIT ELECTRONIC SWITCH KIT

This handy device allows simultaneous oscilloscope observation of two signals by producing both signals, alternately, at its output. It features an all-electronic switching circuit, with no moving parts. Four switching rates are selected by a panel switch. Provides actual gain for input signals, and has a frequency response of ± 1 DB from 0 to 100 kc. Sync output provided to control and stabilize scope sweep. Will function at signal levels as low as 0.1 volt. This modern device finds many applications in the laboratory and service shop. It employs an entirely new circuit, and yet is priced lower than its predecessor.

MODEL S-3

\$21.95

Shpg. Wt. 8 Lbs.

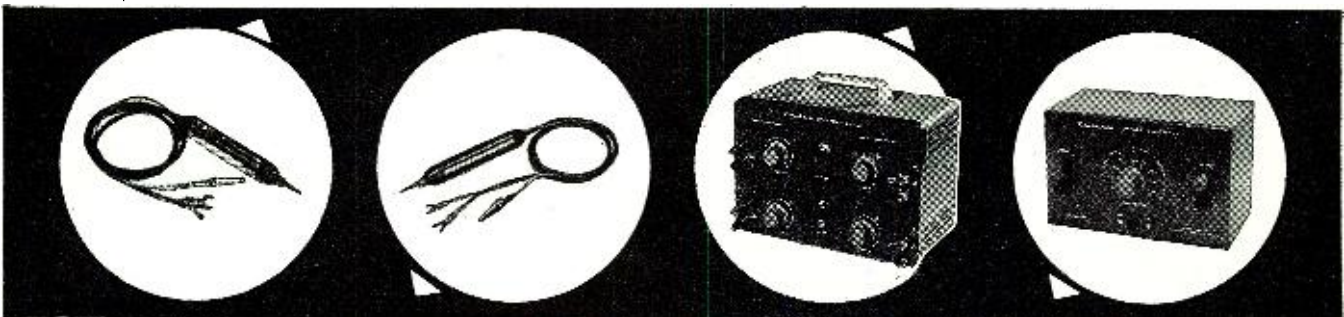

HEATHKIT SCOPE DEMODULATOR PROBE KIT

Extend the usefulness of your oscilloscope by employing this probe. Makes it possible to observe modulation of RF or IF carriers found in TV and radio receivers. Functions much like an AM detector to pass only modulation of signal, and not the signal itself. Among other uses, it will be helpful in alignment work, as a signal tracer, and for determining relative gain. Applied voltage limits are 30 volts (RMS) and 500 volts DC. It uses an etched circuit board to simplify assembly.

NO. 337-C

\$3.50

Shpg. Wt. 1 Lb.

HEATHKIT VOLTAGE CALIBRATOR KIT

This entirely new voltage calibrator produces near-perfect square wave signals of known amplitude. Precision 1% attenuator resistors assure accurate output amplitude, and multivibrator circuit guarantees good, sharp square waves, as distinguished from clipped sine waves. Output frequency is approximately 1000 CPS. Fixed outputs selected by panel switch are: .03, 0.1, 0.3, 1.0, 3.0, 10, 30, and 100 volts peak-to-peak. Allows measurement of unknown signal amplitudes by comparing to known peak-to-peak output of VC-3 on an oscilloscope. Will also double as a square wave generator at 1000 cycles for determining gain, frequency response, or phase-shift characteristics of audio amplifiers. Equally valuable in the laboratory or in radio and TV service shops.

MODEL VC-3

\$12.50

Shpg. Wt. 4 Lbs.

HEATHKIT ETCHED CIRCUIT VACUUM TUBE



MODEL
V-7A

\$24⁵⁰

Shpg. Wt.
7 Lbs.

- * Easy to build — a pleasure to use.
- * 1% precision resistors employed for high accuracy.
- * Etched circuit board cuts assembly time in half.

Voltmeter Kit

The fact that this instrument is the world's largest-selling VTVM says a great deal about its accuracy, reliability, and overall quality. The V-7A is equally popular in the laboratory or service shop, and represents an unbelievable test equipment bargain, without a corresponding sacrifice in quality. Its appearance reflects the performance of which it is capable. A large 4½" panel meter is used for indication, with clear, sharp calibrations for all ranges. Front panel controls consist of a rotary function switch and a rotary range selector switch, zero-adjust, and ohms-adjust controls. Precision 1% resistors are used in the voltage divider circuits and etched circuits are employed for most of the circuitry. This makes the kit much easier to build, eliminates the possibility of wiring errors, and assures duplication of laboratory instrument performance. This multi-function VTVM will measure AC voltage (rms), AC voltage (peak-to-peak), DC voltage, and resistance. There are 7 AC (rms) and DC voltage ranges of 0-1.5, 5, 15, 50, 150, 500, and 1500. In addition, there are 7 peak-to-peak AC ranges of 0-4, 14, 40, 140, 400, 1400, and 4000. 7 ohmmeter ranges provide multiplying factors of X1, X10, X100, X1000, X10K, X100K, and X1 megohm. Center-scale resistance readings are 10, 100, 1000, 10K, 100K ohms, 1 megohm, and 10 megohms. A DB scale is also provided. The precision and quality of the components used in this VTVM cannot be duplicated at this price through any other source. Model V-7A is the kind of instrument you will be proud to own and use.

HEATHKIT Etched Circuit RF PROBE KIT

This RF probe extends the frequency response of any 11-megohm VTVM so that it will measure RF up to 250 megacycles within ± 10%. Employs printed circuits for increased stability and ease of assembly. Ideal for extending service and laboratory applications of your Heathkit VTVM. Shpg. Wt. 1 Lb.

No. 309-C
\$350

HEATHKIT 20,000 OHMS/VOLT VOM KIT

Sensitivity of this instrument is 20,000 ohms-per-volt DC and 5,000 ohms-per-volt AC. Measuring ranges are 0-1.5, 5, 50, 150, 500, 1500, and 5000 volts for both AC and DC. Also measures current in the ranges of 0-150 microamperes, 15 ma, 150 ma, 500 ma, and 15 a. Resistance ranges provide multipliers of X1, X100, and X10,000, resulting in center scale readings of 15, 15,000, and 150,000 ohms. DB ranges cover from -10 db to +65 db. Housed in attractive black bakelite case with plastic carrying handle, this fine instrument provides a total of 25 meter ranges on its two-color scale. It employs a sensitive 50 microampere, 4½" meter and features all 1% precision multiplier resistors. Requires no external power, and is, therefore, valuable in portable applications where no AC power is available. MODEL MM-1

\$29⁵⁰
Shpg. Wt. 6 Lbs.

ETCHED CIRCUIT PEAK-TO-PEAK PROBE KIT

Use this peak-to-peak probe with your 11-megohm VTVM to measure peak-to-peak voltages directly on the DC scales of the instrument. Will measure p-to-p voltages in the frequency range of 5 kc to 5 mc. Employs etched circuit boards for increased circuit stability and simplified construction. Extend the usefulness of your VTVM. NOTE: NO. 338-C Not required for the Heathkit V-7A VTVM. Shpg. Wt. 2 Lbs.

\$55⁰⁰

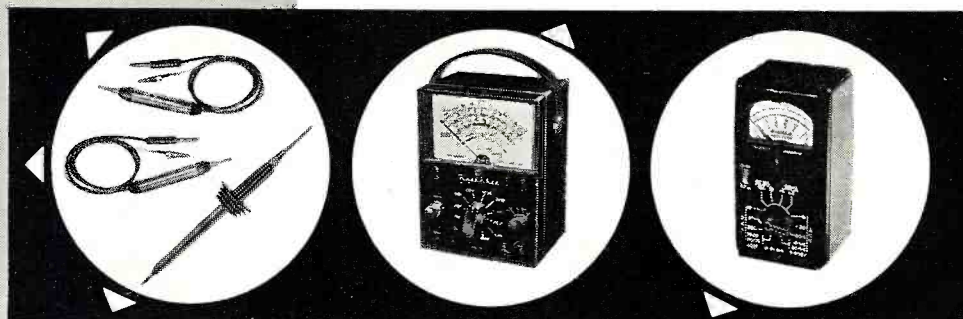

HEATHKIT 30,000 VOLT DC HIGH VOLTAGE PROBE KIT

This probe provides a multiplication factor of 100 on the DC ranges of the Heathkit 11-megohm VTVM. Precision multiplier resistor mounted inside the two-color plastic probe body. Plenty of insulation for completely safe operation, even at highest TV potentials. Designed especially for TV service work.

No. 336
\$45⁰⁰

Shpg. Wt. 2 Lbs.

HEATHKIT HANDITESTER KIT

The Model M-1 measures AC or DC voltage at 0-10, 30, 300, 1000, and 5000 volts. Direct current ranges are 0-10 ma, and 0-100 ma. Ohmmeter ranges are 0-3000 (30 ohm center scale) and 0-300,000 ohms (3,000 ohms center scale). Uses a 400 microampere meter for sensitivity of 1000 ohms-per-volt. A very popular test device for the home experimenter, electricians, and appliance repairmen, and for use as an "extra" instrument in the service shop. Its small size and rugged construction make it perfect for any portable application. Easily slips into your tool box, glove compartment, coat pocket, or desk drawer. Top quality, precision components employed throughout. MODEL M-1

\$14⁵⁰

Shpg. Wt. 3 Lbs.



HEATH COMPANY
A Subsidiary of Daystrom, Inc.
BENTON HARBOR 15, MICH.

CONTROLLED QUALITY . . .

Incoming parts inspection, and inspection of material coming off of our own production line assures you of the finest "build-it-yourself" kit that money can buy. Each kit contains all the components you need for assembly—and you can have confidence in the quality of the parts themselves. In addition to this inspection procedure, an extensive proof-building program for each new kit guarantees easy-to-follow instructions and reliable performance.

This brand new AC vacuum tube voltmeter emphasizes stability, broad frequency response, and sensitivity. It is designed especially for audio measurements, and low-level AC measurements in power supply filters, etc. Employs a cascode amplifier circuit with cathode-follower isolation between the input and the amplifier, and between the output stage and the preceding stages. An extremely stable circuit with high input impedance (1 megohm at 1000 CPS). Response of the AV-3 is essentially flat from 10 CPS to 200 kc, and is usable for tests even beyond these frequency limits. Increased damping in the meter circuit stabilizes the meter for low frequency tests. Nylon insulating bushings at the input terminals reduce leakage, and permit the use of the 5-way Heath binding post.

The extremely wide voltage range covered by the AV-3 makes it especially valuable not only in high-fidelity and service work, but also in experimental laboratories. AC (RMS) voltage ranges are 0-.01, .03, .1, .3, 1, 3, 10, 30, 100, and 300 V. Decibel ranges cover -52 DB to +52 DB. An entirely new circuit as compared to the previous model. Employs 1% precision multiplier resistors for maximum accuracy. Handles AC measurements from a low value of one millivolt to a maximum of 300 volts.

HEATHKIT NEW AUDIO VACUUM TUBE

Voltmeter Kit

- * Brand new circuit for extended frequency response and added stability.
- * Ten accurate ranges from 0-.01 to 0-300 volts.
- * Modern, functional panel styling. "On-off" switch at both extreme ends of range switch.

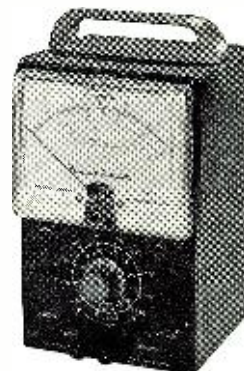

MODEL AV-3

\$29⁹⁵

Shpg. Wt.
5 Lbs.

HEATHKIT AUDIO WATTMETER KIT

This instrument measures audio power directly at 4, 8, 16, or 600 ohms. Load resistors are built in. Covers 0-5 MW, 50 MW, 500 MW, 5 W, and 50 W full scale. Provides 5 switch-selected DB ranges covering from -10 DB to +30 DB. Large 4½" 200 microampere meter and precision multiplier resistors insure accuracy. Frequency response is ± 1 DB from 10 CPS to 250 kc. Functions from AC power line. Use in the audio laboratory or in home workshop.

MODEL AW-1

\$29⁵⁰

Shpg. Wt. 6 Lbs.

HEATHKIT AUDIO ANALYZER KIT

This multi-function instrument combines an AC VTVM, an audio wattmeter, and an intermodulation analyzer into one case, with combined input and output terminals and built-in high and low frequency oscillators. The VTVM ranges are .01, .03, .1, .3, 1, 3, 10, 30, 100, and 300 volts (RMS). Wattmeter ranges are .15 MW, 1.5 MW, 15 MW, 150 MW, 1.5 W, 15 W, 150 W. IM scales are 1%, 3%, 10%, 30%, and 100%. Provides internal load resistors of 4, 8, 16, or 600 ohms. A valuable instrument for the engineer or serious audiophile.

MODEL AA-1

\$49⁹⁵

Shpg. Wt. 13 Lbs.

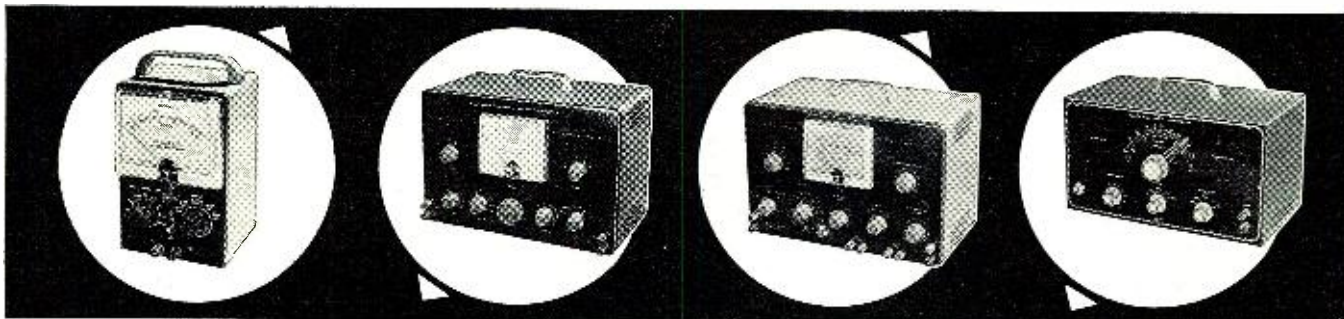

HEATHKIT HARMONIC DISTORTION METER KIT

The HD-1 is equally valuable for the audio engineer or the serious audiophile. Used with a low-distortion audio signal generator, this instrument will measure the harmonic content of various amplifiers under a variety of conditions. Functions between 20 and 20,000 CPS, and reads distortion directly on the panel meter in ranges of 0-1, 3, 10, 30, and 100 percent full scale. Built-in VTVM for initial reference settings and final distortion readings has voltage ranges of 0-1, 3, 10, and 30 volts. 1% precision resistors employed for maximum accuracy. Features voltage regulation and other "extras". Meter calibrated in volts (RMS), percent distortion, and DB.

MODEL HD-1

\$49⁵⁰

Shpg. Wt. 13 Lbs.

HEATHKIT AUDIO OSCILLATOR KIT

Producing both sine waves and square waves, the Model AO-1 covers a frequency range of 20 to 20,000 CPS in three ranges. An extra feature is thermistor regulation of output for flat response through the entire frequency range. AF output is provided at low impedance, and with low distortion. Produces good sine waves, and good, clean square waves with a rise time of only two micro-seconds for checking square wave response of audio amplifiers, etc. Designed especially for the serviceman and high-fidelity enthusiast. A real dollar value in test equipment.

MODEL AO-1

\$24⁵⁰

Shpg. Wt. 10 Lbs.

HEATHKIT



\$34⁵⁰

Shpg. Wt.
8 Lbs.

- * Less than 0.1% distortion — ideal for hi fi work.
- * Large 4½" meter indicates output.
- * Step-type tuning for maximum convenience.

Audio Generator Kit

This particular audio generator is "made to order" for high fidelity applications. It provides quick and accurate selection of low-distortion signals throughout the audio range. Three rotary selector switches on the front panel allow selection of two significant figures and a multiplier for determining audio frequency. In addition, it incorporates a step-type output attenuator and a continuously variable attenuator. Output is indicated on a large 4½" panel meter calibrated in volts and in db. Attenuator system operates in steps of 10 db, corresponding with the meter calibration. Output ranges are 0-.003, .01, .03, .1, .3, 1, 3, and 10 volts rms. A "load" switch provides for the use of a built-in 600 ohm load or an external load of higher impedance when required. Output and frequency indicators accurate to within ± 5%. Distortion is less than .1 of 1% between 20 cps and 20,000 cps. Total range is 10 cps to 100 kc. New engineering details combine to provide the user with an unusually high degree of operating efficiency. Oscillator frequency selected entirely by the switch method means that accurate resetability is provided. Comparable to units costing many dollars more, and ideal for use in critical high fidelity applications. Shop and compare, and you will appreciate the genuine value of this professional instrument.

HEATHKIT RESISTANCE SUBSTITUTION BOX KIT

The RS-1 contains 36 10% 1-watt resistors ranging from 15 ohms to 10 megohms in standard RETMA values. All values are switch-selected for use in determining desirable resistance values in experimental circuits. Many applications in radio and TV service work.

MODEL RS-1

\$5⁵⁰

Shpg. Wt. 2 Lbs.

HEATHKIT CONDENSER SUBSTITUTION BOX KIT

This kit contains 18 RETMA standard condenser values that can be selected by a rotary switch. Values range from 0.00001 mfd to 0.22 mfd. All capacitors rated at 400 volts or higher. Capacitors are either silver-mica, or plastic molded.

MODEL CS-1

\$5⁵⁰

Shpg. Wt. 2 Lbs.

HEATHKIT AUDIO GENERATOR KIT

The Model AG-8 is a low cost, high performance unit for use in service shop, or home workshop. It covers the frequency range of 20 cps to 1 mc in five ranges. Output is 600 ohms, and overall distortion will be less than .4 of 1% from 100 cps through the audible range. Output is available up to 10 volts, under no load conditions, and output remains constant within ±1 db from 20 cps to 400 kc. A five-step attenuator provides control of the output. Precision resistors are employed in the frequency determining network.

MODEL AG-8

\$29⁵⁰

Shpg. Wt. 11 Lbs.

HEATHKIT DECADE CONDENSER KIT

Precision, 1% silver-mica capacitors are employed in the Model DC-1 in such a way that a selection of precision capacitor values is provided ranging from 100 mmf (.0001 mfd) to 0.11 mfd (110,000 mmf) in 100 mmf steps. Extremely valuable in all types of design and development work. Switches are ceramic wafer types.

MODEL DC-1

\$16⁵⁰

Shpg. Wt. 3 Lbs.

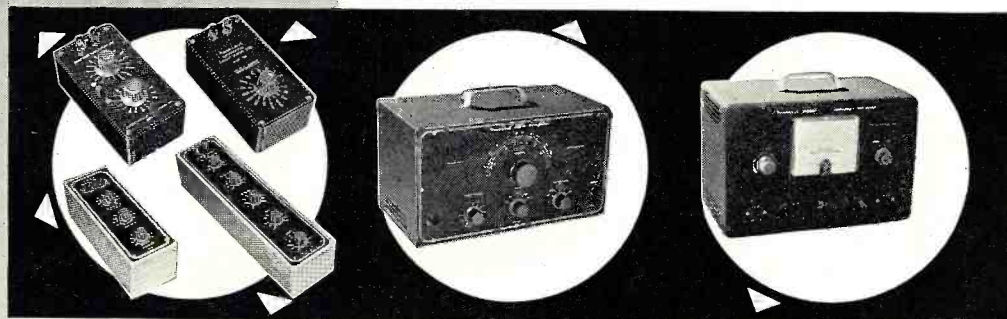

HEATHKIT DECADE RESISTANCE KIT

The Model DR-1 incorporates twenty 1% precision resistors arranged around five rugged switches so that various combinations of switch positions will provide a total range of 1 ohm to 99,999 ohms in 1-ohm steps. Switches are labeled "units," "tens," "hundreds," "thousands," and "ten thousands." Use it for ohm-meter calibration in bridge circuits as test values in multiplier circuits, etc.

MODEL DR-1

\$19⁵⁰

Shpg. Wt. 4 Lbs.

HEATHKIT VARIABLE VOLTAGE REGULATED POWER SUPPLY KIT

This power supply is regulated for stability, and the amount of DC output available from the power supply can be controlled manually from zero to 500 volts. Will provide regulated output at 450 volts up to 10 ma, or up to 130 ma at 200 volts output. In addition to furnishing B-plus, the power supply provides 6 volts AC at 4 amperes for filaments. Both the B-plus output and the filament output are isolated from ground. Ideal power supply for use in experimental work in the laboratory, the home workshop, or the ham shack. Large 4½" panel meter indicates output voltage or current.

MODEL PS-3

\$35⁵⁰

Shpg. Wt. 17 Lbs.



HEATH COMPANY

A Subsidiary of Daystrom, Inc.

BENTON HARBOR 15, MICH.

BONUS PERFORMANCE . . .

If a single word had to be selected to describe Heath Company advertising policy, it would be "conservative." By this we mean that the performance specifications and features are not exaggerated, and that the descriptions are accurate. We specify performance on the conservative side so you can be sure of equaling or exceeding our specifications. In almost every instance our kits will do more than we claim. Extra care in construction, and calibration against an accurate standard can extend performance well beyond advertised levels.

HEATHKIT

Signal Generator Kit

- * No calibration required with pre-aligned coils.
- * Modulated or unmodulated RF output.
- * 110 mc to 220 mc frequency coverage.

Here is an RF signal generator for alignment applications in the service shop or the home workshop. Thousands of these units are in use in service shops all over the country. Produces RF signals from 160 kc to 110 mc on fundamentals on five bands. Also covers from 110 mc to 220 mc on calibrated harmonics. RF output is in excess of 100,000 microvolts at low impedance. Output is controllable with a step-type and a continuously variable attenuator. Front panel controls provide selection of either unmodulated RF output or RF modulated at 400 cps. In addition, two to three volts of audio at approximately 400 cps are available at the output terminals for testing AF circuits. Employs a 12AU7 and a 6C4 tube. Built-in power supply uses a selenium rectifier.

One of the most outstanding features about the Model SG-8 is the fact that it can be built in just a few hours, even by one not thoroughly experienced in electronics work. Complete step-by-step instructions combined with large pictorial diagrams assure successful assembly. Pre-aligned coils make calibration from an external source unnecessary.



MODEL SG-8

\$19⁵⁰ Shpg. Wt. 8 Lbs.

HEATHKIT LABORATORY GENERATOR KIT

This laboratory RF signal generator covers from 100 kc to 30 mc on fundamentals in five bands. The output signal may be pure RF, or may be modulated at 400 cycles from 0 to 50%. Provision for external modulation has been made. RF output available up to 100,000 microvolts. Output controlled by a fixed step and a variable attenuator. Output impedance is 50 ohms. Panel meter reads RF output or percentage of modulation. Incorporates voltage regulated B+ supply, double shielding of oscillator circuits, copper plated chassis, and other "extras."

MODEL LG-1
\$48⁹⁵

Shpg. Wt. 16 Lbs.

HEATHKIT TV ALIGNMENT GENERATOR KIT

This improved sweep generator model provides essential stability and flexibility for work on FM, monochrome TV, or color TV sets. Covers 3.6 mc to 220 mc in four bands. Provides usable output even on harmonics. Sweep deviation from 0-42 mc, depending on base frequency. All-electronic sweep circuit eliminates unwieldy mechanical arrangements. Includes built-in crystal marker generator providing output at 4.5 mc and multiples thereof, and variable marker covering 19 to 60 mc on fundamentals and from 57 to 180 mc on harmonics. Effective two-way blanking.

MODEL TS-4A
\$49⁵⁰

Shpg. Wt. 16 Lbs.

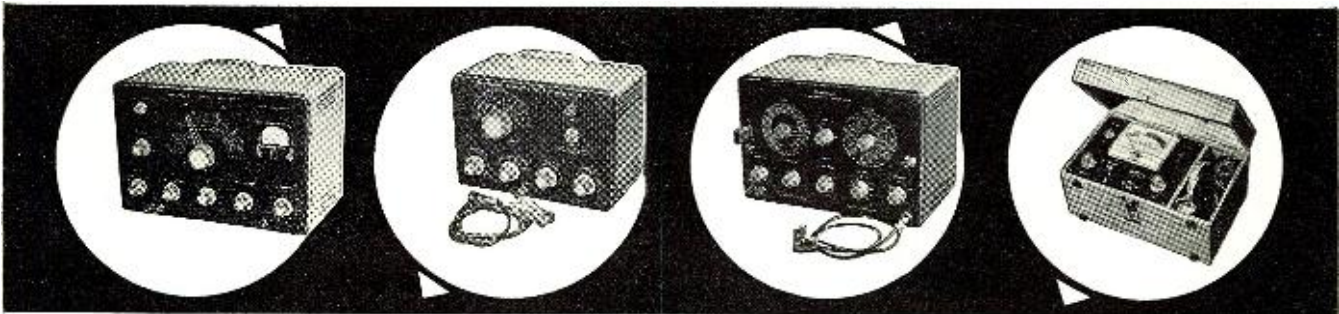

HEATHKIT LINEARITY PATTERN GENERATOR KIT

This instrument supplies information for white dots, cross-hatch pattern, horizontal bar pattern, or vertical bar pattern. It feeds video and sync signals to the set under test, with completely controlled gain, and unusual stability. Covering channels 2 to 13, the LP-2 will produce 5 to 6 vertical bars and 4 to 5 horizontal bars. The dot pattern presentation is a *must* for the setting of color convergence controls in the color TV set. Panel provision made for external sync if desired. Use for adjustment of vertical and horizontal linearity, picture size, aspect ratio, and focus. Power supply is regulated for added stability. Essential in the up-to-date TV service shop.

MODEL LP-2
\$22⁵⁰

Shpg. Wt. 7 Lbs.

HEATHKIT CATHODE RAY TUBE CHECKER KIT

This instrument checks cathode emission, beam current, shorted elements, and leakage between elements in electro-magnetic picture tube types. It eliminates all doubt for the TV serviceman, and even more important, for the customer. Features its own self-contained power supply, transformer operated to furnish normal test voltages for the CRT. Employs spring-loaded switches for maximum operator protection. Large 4 1/2" meter indicates CRT condition on "good-bad" scale. Luggage-type portable case ideal for home service calls. Special "shadowgraph" test permits projection of light spot on screen. Also gives relative check of picture tube screen coating.

MODEL CC-1
\$22⁵⁰

Shpg. Wt. 10 Lbs.

HEATHKIT



MODEL
TC-2

\$29⁵⁰

Shpg. Wt.
12 Lbs.

- * Attractive counter-style cabinet.
- * Wiring-harness simplifies assembly.
- * Large 4½" meter with two-color "good-bad" scale.
- * Separate tube element switches prevent obsolescence.

Tube Checker Kit

This fine piece of test gear checks tubes for quality, emission, shorted elements, open elements, and filament continuity. Will test all tube types normally encountered in radio and TV service work. Sockets provided for 4, 5, 6, and 7-pin large, rectangular, and miniature types, octal and loctal types, the Hytron 9-pin miniatures, and pilot lamps. Condition of tubes indicated on a large 4½" meter with multi-color "good-bad" scale. An illuminated roll chart is built right in, providing test data for various tube types. This tester provides switch selection of 14 different filament voltage values from 0.75 volts to 117 volts. Individual switches control each tube element. Close tolerance resistors employed in critical test circuits for maximum accuracy. A professional instrument both in appearance and performance.

The Model TC-2 is very simple to build, even for a beginner. It employs a color-coded cable harness for neat, professional under-chassis wiring. Comes with attractive counter style cabinet, and portable cabinet is available separately. At this price, even the part-time serviceman can afford his own tube checker for maximum efficiency in service work.

HEATHKIT TV PICTURE TUBE TEST ADAPTER



MODEL 355

\$4⁵⁰

Shpg. Wt.
1 Lb.

Designed especially for use with the Model TC-2 tube checker. Use it to test TV picture tubes for emission, shorts, etc. Consists of 12-pin TV tube socket, 4 ft. cable, octal connector, and necessary technical data. Not a kit.

HEATHKIT PORTABLE TUBE CHECKER KIT

This portable tube checker is identical, electrically, with the Model TC-2. However, it is housed in an attractive and practical carrying case, finished in proxylin impregnated material. The cover is detachable, and the hardware is brass plated. This rugged unit is ideal for home service calls or any portable application.

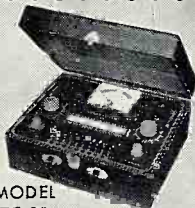

MODEL
TC-2P

\$34⁵⁰ Shpg. Wt.
15 Lbs.

HEATHKIT VISUAL-AURAL SIGNAL TRACER KIT

Although designed primarily for radio receiver work, this valuable instrument finds extensive application in FM and TV servicing as well. Features a high-gain channel with demodulator probe, and a low-gain channel with audio probe. Will trace signals in all sections of a radio receiver and in many sections of a FM set or TV receiver. Uses built-in speaker and electron beam eye tube for indication. Also features built-in wattmeter and a noise locator circuit. Provision for patching speaker and/or output transformer into external set.

MODEL T-3

\$23⁵⁰

Shpg. Wt. 9 Lbs.

HEATHKIT DIRECT READING CAPACITY METER KIT

Operation of this instrument is simplicity itself. One has only to connect a capacitor to the terminals, select the proper range, and read the capacity value directly on the large 4½" meter calibrated in mmf and mfd. Ranges are 0 to 100 mmf, 1,000 mmf, 0.01 mfd, and 0.1 mfd full scale. Precision calibrating capacitors supplied. Not susceptible to hand capacity effects. Residual capacity less than 1 mmf. Especially valuable in production line checking, or in quality control.

MODEL CM-1

\$29⁵⁰

Shpg. Wt.
7 Lbs.

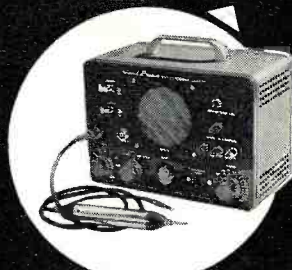

HEATHKIT CONDENSER CHECKER KIT

The Model C-3 consists of an AC powered bridge for both capacitive and resistive measurements. Bridge balance is indicated on electron beam eye tube, and capacity or resistance value is indicated on front panel calibrations. Measures capacity in four ranges from .00001 mfd to .005 mfd, .001 mfd to .5 mfd, .1 mfd to 50 mfd, and 20 mfd to 1000 mfd. Measures resistance in two ranges, from 100 ohms to 50,000 ohms, and from 10,000 ohms to 5 megohms. Selection of five different polarizing voltages for checking capacitors, from 25 volts DC to 450 volts DC. Checks paper, mica, ceramic, and electrolytic capacitors. Indicates power factor of electrolytic condensers.

MODEL C-3

\$19⁵⁰

Shpg. Wt. 7 Lbs.



HEATH COMPANY

A Subsidiary of Daystrom, Inc.

BENTON HARBOR 15, MICH.

PIONEER DESIGN . . .
 New and unique approaches to instrument and equipment designs are a Heath Company tradition. We concentrate all our development efforts on kit projects, since this is our prime activity—and not just a sideline. This logically results in more efficient, more reliable circuit designs—and you benefit from this constant engineering progress. Buying from the undisputed leader in the electronic kit field assures you of completely modern equipment, with outstanding advanced design features.

HEATHKIT

Impedance Bridge Kit

- * 1/2% precision resistors and silver-mica capacitors.
- * Battery-type tubes, no warm-up required.
- * Built-in phase shift generator and amplifier.

The Model IB-2 is a completely self-contained unit. It has a built-in power supply, a built-in 1000 cycle generator, and a built-in vacuum tube detector. Provision has been made on the panel for connection to an external detector, an external signal generator, or an external power supply. A 100-0-100 micro-ampere meter on the front panel provides for null indications. Measures resistance from 0.1 ohm to 10 megohms, capacitance from 10 mmf to 100 mfd, inductance from 10 mh to 100 h, dissipation factor (D) from 0.002 to 1, and storage factor (Q) from 0.1 to 1000. 1/2 of 1% decade resistors employed for maximum accuracy. Typical accuracy figures are: resistance, ±3%; capacitance ±3%; inductance, ±10%; dissipation factor, ±20%; storage factor, ±20%. Employs a Wheatstone bridge, a Capacity Comparison bridge, a Maxwell bridge, and a Hay bridge. Special two-section CRL dial provides maximum convenience in operation. Use the Model IB-2 for determining values of unmarked components, checking production or design samples, etc. A real professional instrument.

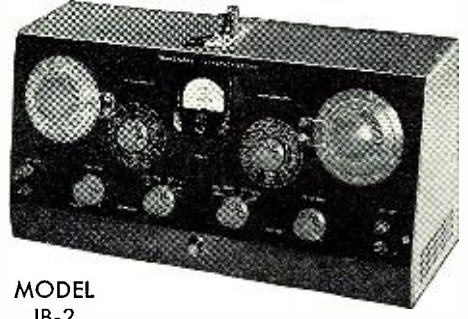

MODEL IB-2
\$59⁵⁰ Shpg. Wt. 12 Lbs.

HEATHKIT "Q" METER KIT

The Q Meter permits measurement of inductance from 1 microhenry to 10 millihenries, "Q" on a scale calibrated up to 250 full scale, with multiplying factors of 1 or 2, and capacitance from 40 mmf to 450 mmf, ±3 mmf. Built-in variable oscillator permits testing components from 150 kc to 18 mc. Large 4 1/2" panel-mounted meter is features. Very handy for checking peaking coils, chokes, etc. Use to determine values of unknown condensers, both variable and fixed. Compile data for coil winding purposes, or measure RF resistance. Distributed capacity, and Q of coils.

MODEL QM-1
\$44⁵⁰
 Shpg. Wt. 14 Lbs.

HEATHKIT ISOLATION TRANSFORMER KIT

This device isolates equipment under test from the power line. It is rated at 100 volt-amperes continuously, or 200 volt-amperes intermittently. AC-DC sets may be plugged directly into the IT-1 without the chassis becoming "hot." Additionally, since the IT-1 is fused, it is ideal for use as a buffer between the power line and a questionable receiver, or a new piece of equipment. Protects main fuses. Features voltage control, allowing control of the output from 90 volts to 130 volts. Panel meter monitors output voltage. A very handy device at an extremely low price.

MODEL IT-1
\$16⁵⁰
 Shpg. Wt. 9 Lbs.

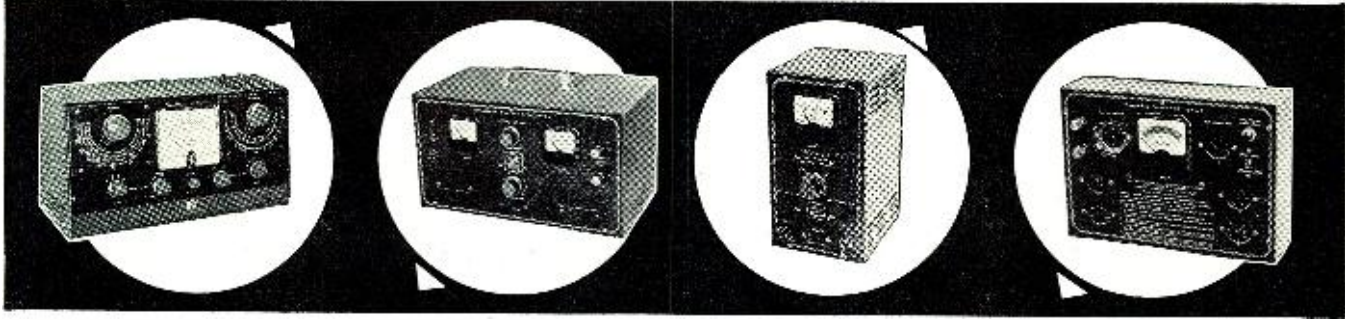

HEATHKIT 6-12 VOLT BATTERY ELIMINATOR KIT

This completely modern battery eliminator will supply DC output in two ranges for both 6-volt and 12-volt automobile radios. The output is variable for each range, so that operating voltage can be raised or lowered to determine how the receiver functions under adverse conditions. Range is 0-8 volts DC or 0-16 volts DC. Will supply up to 15 amperes on the 6-volt range, or up to 7 amperes on the 12-volt range. Two 10,000 microfarad output filter capacitors insure smooth DC output. Two separate panel meters indicate output voltage or output current. Makes it possible to test automobile radios inside at the workbench. Will also double as a battery charger.

MODEL BE-4
\$31⁵⁰
 Shpg. Wt. 17 Lbs.

HEATHKIT 6-VOLT VIBRATOR TESTER KIT

This instrument functions very much like a tube checker, to test auto radio vibrators. Vibrator condition is indicated on a simple "good-bad" scale. Tests for proper starting and overall quality of operation, of both interrupter and self-rectifier types of 6-volt vibrators. The model VT-1 is designed to operate from any battery eliminator capable of delivering continuously variable output from 4 to 6 volts DC at 4 amperes or more. It is an ideal companion unit for the Heathkit Model BE-4 battery eliminator. The construction book for the VT-1 contains vibrator test chart for popular 6-volt vibrator types. A real time saver!

MODEL VT-1
\$14⁵⁰
 Shpg. Wt. 6 Lbs.

HEATHKIT DX-100 PHONE AND CW



**MODEL
DX-100**
Shpg. Wt.
107 Lbs.

\$189⁵⁰

Shipped motor freight unless otherwise specified.
\$50.00 deposit required on c.o.d. orders.

- * Phone or CW on 160, 80, 40, 20, 15, 11 and 10 meters.
- * Built-in VFO, modulator, and power supplies.
- * High quality components used throughout for reliable performance.
- * Features 5-point TVI suppression.

HEATHKIT COMMUNICATIONS TYPE ALL BAND RECEIVER KIT

This receiver covers 550 kc to 30 mc in four bands, and is ideal for the short-wave listener or beginning amateur. It provides good sensitivity and selectivity, combined with good image rejection. Amateur bands clearly marked on illuminated dial scale. Employs transformer type power supply—electrical bandspread—antenna trimmer—separate RF and AF gain controls—noise limiter—headphone jack—and automatic gain control. Has built-in BFO for CW reception.

CABINET: Fabric covered cabinet with aluminum panel as shown. Part 91-15A. Shipping weight 5 Lbs. \$4.95

MODEL AR-3
\$299⁵

INCLUDING NEW
EXCISE TAX
(Less Cabinet)
Shpg. Wt. 12 Lbs.

Transmitter Kit

The Heathkit DX-100 transmitter is in a class by itself in that it offers features far beyond those normally received at this price level. It takes very little listening on the bands to discover how many of these transmitters are in operation today. A truly amazing piece of amateur gear. The DX-100 features a built-in VFO and a built-in modulator. It is TVI suppressed, and uses pi network interstage coupling and output coupling. Will match antenna impedances from approximately 50 to 600 ohms. Extensive shielding is employed, and all incoming and outgoing circuits are filtered. The cabinet features interlocking seams for simplified assembly and minimum RF radiation outside of the cabinet. Provides a clean strong signal on either phone or CW, with RF output in excess of 100 watts on phone, and 120 watts on CW. Completely bandswitching from 160 through 10 meters. A pair of 1625 tubes are used in push-pull for the modulator, and the final consists of a pair of 6146 tubes in parallel. The VFO dial and meter face are illuminated, and all front panel controls are located for maximum convenience. Panel meter reads driver plate I, final grid I, final plate I, final plate voltage, and modulator current. The chassis is constructed of heavy #16 gauge copper-plated steel. Other high-quality components include potted transformers, ceramic switch and variable capacitor insulation, silver-plated or solid-silver switch terminals, etc. All coils are pre-wound, and the main wiring cable is pre-harnessed. The kit can be built by a beginner from the comprehensive step-by-step instructions supplied. It is a proven, trouble-free rig, that will insure many hours of "on-the-air" enjoyment in your ham shack.

HEATHKIT VFO KIT

You can go VFO for less than you might expect. Here is a variable frequency oscillator that covers 160, 80, 40, 20, 15, 11, and 10 meters with three basic oscillator frequencies, that sells for less than \$20. Provides better than 10 volt average RF output on fundamentals. Plenty of drive for most modern transmitters. Requires a power source of only 250 VDC at 15 to 20 ma. and 6.3 VAC at 0.45A. Incorporates a regulator tube for stability. Illuminated frequency dial reads frequency directly on the band being employed. Temperature-compensated capacitors offset coil heating.

MODEL VF-1

\$19⁵⁰

Shpg. Wt. 7 Lbs.



EASY ON THE BUDGET!

You can buy Heathkits on an easy time-payment plan that provides a full year to pay. Write for complete details and special order blank.

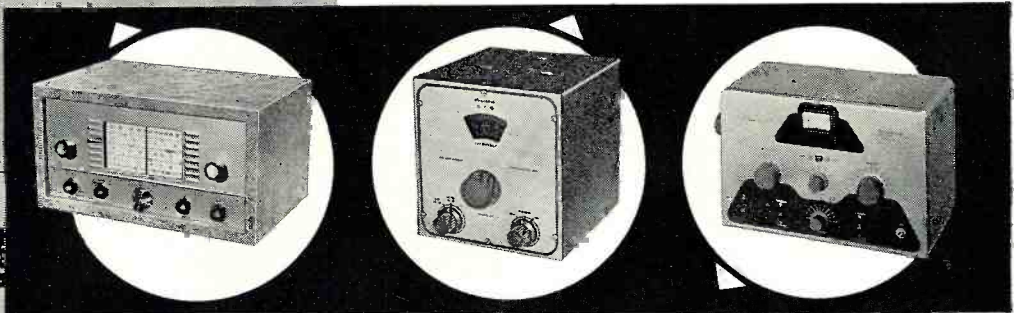

NEW HEATHKIT CW TRANSMITTER KIT

The brand new Heathkit Model DX-20 Transmitter is one of the most efficient little rigs available today. Featuring an entirely new circuit, it is ideal for the novice, and even for the advanced-class CW operator. A 6DQ6A final amplifier provides plate power input of 50 watts. A 6CL6 oscillator is employed, and a 5U4GB rectifier. The transmitter features one-knob bandswitching to cover 80, 40, 20, 15, 11 and 10 meters. It is designed for crystal excitation, but may be excited by an external VFO. A pi network output circuit matches antenna impedances between 50 and 1000 ohms. Front panel controls are functionally located for your convenience. If you appreciate a good signal on the CW bands, this is the transmitter for you!

MODEL DX-20

\$35⁹⁵

Shpg. Wt. 18 lbs.



HEATH COMPANY

A Subsidiary of Daystrom, Inc.

BENTON HARBOR 15, MICH.

DOLLAR-SAVING ECONOMY . . .
 There would be no particular achievement in selling inexpensive merchandise at a low price—although it is being done every day. However, there is something to crow about when, through tremendous purchasing power and factory-to-you distribution, Heath Company can offer top-quality equipment, using name-brand components, at such low prices. This is real economy, as opposed to the so-called "bargains". Needless to say, there is a big difference.

**HEATHKIT PHONE AND CW
 Transmitter Kit**

- * 6146 final amplifier for full 65-watt plate power input.
- * Phone and CW operation on 80, 40, 20, 15, 11, and 10 meters. Pi network output coupling.
- * Switch selection of three crystals — provision for external VFO excitation.

The DX-35 features a 6146 final amplifier to provide 65 watts plate power input on CW, with controlled carrier modulation peaks up to 50 watts on phone. In addition, it is a most attractive transmitter. Modulator and power supplies are built-in, and the rig covers 80, 40, 20, 15, 11, and 10 meters with a single band-change switch. Pi network output coupling provided for matching various antenna impedances. A 12BY7 buffer stage provided ahead of the final amplifier for plenty of drive on all bands. 12BY7 oscillator and 12AU7 modulator. Provision for switch selection of three different crystals. Crystals reached through access door at rear. Front panel controls marked "off—CW—stand-by—phone", "final tuning", "antenna coupling", "drive level control", and "band change switch". Panel meter indicates final grid current or final plate current. A perfect low-power transmitter both for the novice, and for the more experienced operator. A remarkable power package for the price. Incidentally, the price includes tubes, and all other components necessary for assembly. As with all Heathkits, comprehensive instruction manual assures successful assembly.



MODEL DX-35
\$56⁹⁵ Shpg. Wt. 24 Lbs.

HEATHKIT ANTENNA IMPEDANCE METER KIT

This instrument employs a 100 microampere panel meter and covers the impedance range of 0-600 ohms for RF tests. Functions up to 150 mc. Used in conjunction with signal source, such as the Heathkit Model GD-1B grid dip meter, the Model AM-1 will determine antenna resistance and resonance, match transmission lines for minimum standing wave ratio, determine receiver input impedance, etc. Will also double as a phone monitor. A very valuable device for many uses in the ham shack.

MODEL AM-1
\$14⁵⁰
 Shpg. Wt. 2 Lbs.

HEATHKIT "Q" MULTIPLIER KIT

The QF-1 functions with any receiver with an IF frequency between 450 and 460 kc that is not AC-DC type. Operates from the receiver power supply, requiring only 6.3 VAC at 300 ma. and 150 to 250 VDC at 2 ma. Simple to connect with cable and plugs supplied. Provides additional selectivity for separating two signals, or will reject one signal and eliminate heterodyne. A big help on crowded bands. Provides an effective Q of approximately 4,000 for sharp "peak" or "null". Tunes to any signal within the IF bandpass of the receiver, without changing main receiver tuning dial.

MODEL QF-1
\$9⁹⁵
 Shpg. Wt. 3 Lbs.

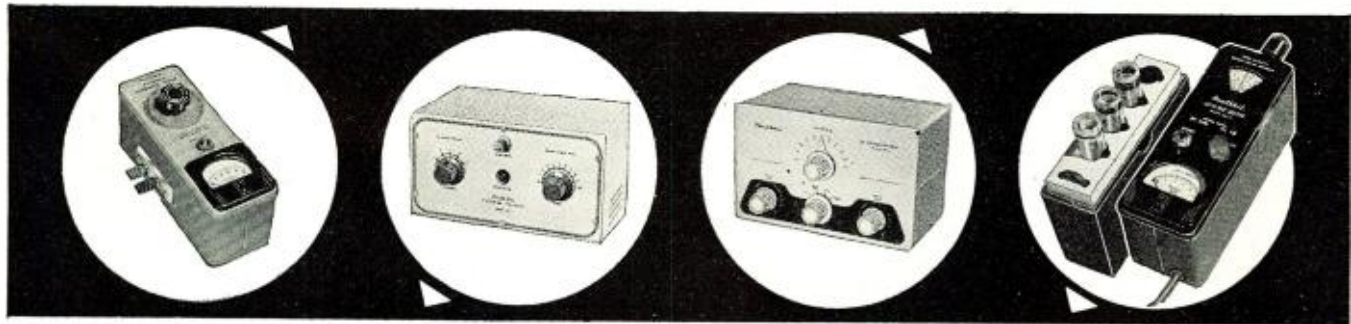

HEATHKIT ANTENNA COUPLER KIT

This device is designed to match the Model AT-1 transmitter to a long-wire antenna. In addition to impedance matching, this unit incorporates an L-type filter which attenuates signals above 36 megacycles, thereby reducing TVI. Designed for 52 ohm coaxial input. Handles power up to 75 watts, 10 through 80 meters. Uses a tapped inductor and variable capacitor. Neon RF indicator on front panel. Copper-plated chassis—high quality components throughout—simple to build. Eliminates waste of valuable communications power due to improper matching. A "natural" for all AT-1 transmitter owners.

MODEL AC-1
\$14⁵⁰
 Shpg. Wt. 4 Lbs.

HEATHKIT GRID DIP METER KIT

The grid dip meter was originally designed for the ham shack. However, its use has been extended into the service shop and laboratory. Continuous frequency coverage from 2 mc to 250 mc with pre-wound coils. 500 microampere panel meter employed for indication. Use for locating parasitics, neutralizing, determining RF circuit resonant frequencies, etc. Coils are included with kit, as is a coil rack. Front panel controls include sensitivity control for meter, and phone jack for listening to zero-beat. Will also double as an absorption-type wavemeter.

MODEL GD-1B
\$19⁹⁵
 Shpg. Wt. 4 Lbs.

HEATHKIT BROADCAST BAND

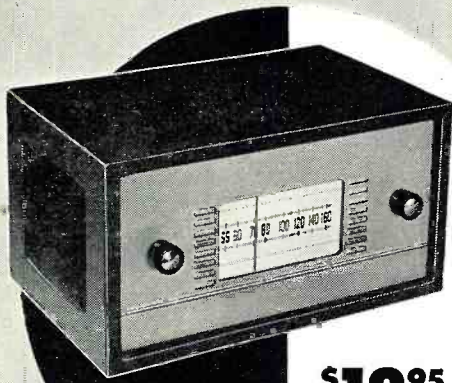

MODEL BR-2
(Less Cabinet)
Shpg. Wt. 10 Lbs.

\$18⁹⁵

INCLUDING NEW
EXCISE TAX*

ATTENTION BEGINNERS . . .

This kit is an ideal "first project" if you have never built a Heathkit before. A good chance to "learn by doing."

- * Miniature tubes and high-gain IF transformer.
- * Rod-type built-in antenna. Good sensitivity and selectivity.
- * 5½-inch PM speaker.
- * Provision for phono jack.
- * Transformer-operated power supply.

Receiver Kit

You need no previous experience in electronics to build this table-model radio. The Model BR-2 receiver covers 550 kc to 1620 kc and features good sensitivity and selectivity over the entire band. A 5½" PM speaker is employed, along with high gain miniature tubes and a new rod-type built-in antenna. Provision has been made in the design of this receiver for its use as a phonograph amplifier. The phono jack is located on the back chassis apron. A transformer operated power supply is featured for safety of operation, as opposed to the usual AC-DC supply commonly found in "economy radio kits." Don't let the low Heathkit price deceive you. This is the kind of set you will want to show off to your family and friends after you have finished building it.

Construction of this radio kit is very simple. Giant size pictorial diagrams and detailed step-by-step instructions assure your success. The construction manual also includes an explanation of basic receiver circuit theory so you can "learn by doing" as the receiver is built. The manual even provides information on resistor and capacitor color codes, soldering techniques, use of tools, etc. If you have ever had the urge to build your own radio receiver, the outstanding features of this popular Heathkit deserve your attention.

CABINET: Proxylin impregnated fabric covered plywood cabinet available for the BR-2 receiver as shown. Complete with aluminum panel, reinforced speaker grill, and protective rubber feet. Shipping weight 5 lbs., part No. 91-9A.....\$4.95*

HEATHKIT PROFESSIONAL RADIATION COUNTER KIT

This sensitive and reliable instrument has already found extensive application in prospecting, and also in medical and industrial laboratories. It offers outstanding performance at a reasonable price. Front-panel meter indicates radiation level, and oral indication produced by panel-mounted speaker. Meter ranges are 0-100, 600, 6,000 and 60,000 counts per minute, and 0—.02, .1, 1 and 10 milliroentgens per hour. The probe, with expansion cord, employs type 6306 bismuth counter tube, sensitive to both beta and gamma radiation. It is simple to build, even for a beginner.

MODEL RC-1
\$79⁹⁵
Shpg. Wt. 8 Lbs.

HEATHKIT CRYSTAL RECEIVER KIT

The crystal radio of Dad's day is back again, but with big improvements! The Model CR-1 employs a sealed germanium diode, eliminating the critical "cat's whisker" adjustment. It is housed in a compact plastic box, and features two HI-Q tank circuits, employing ferrite core coils and variable air tuning capacitors. The CR-1 covers the standard broadcast band from 540 kc to 1600 kc, and no external power is required for operation. Could prove valuable for emergency signal reception. This easy-to-build kit is a real "learn by doing" experience for the beginner, and makes an interesting project for all ages.

MODEL CR-1
\$7⁹⁵
INCLUDING NEW
EXCISE TAX*
Shpg. Wt. 3 Lbs.

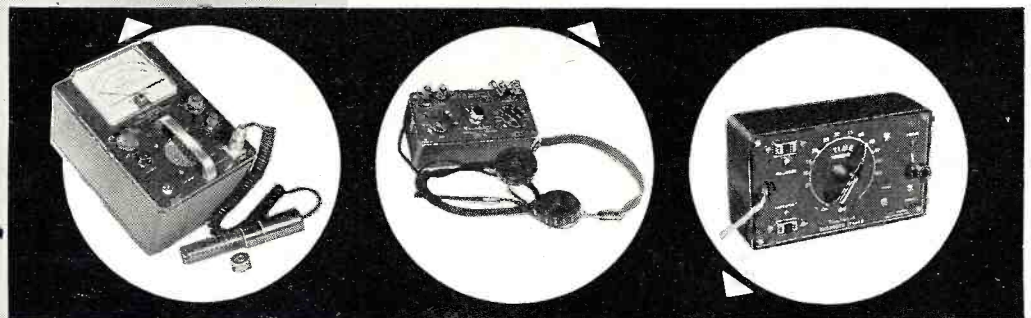

* Amazing new circuit for high efficiency.

- * Compact, portable and rugged.
- * Stable circuit requires only one 67½ volt "B" battery and two 1½ volt "A" batteries.

HEATHKIT ENLARGER TIMER KIT

The Model ET-1 is an easy-to-build device for use by amateur or professional photographers in controlling the timing cycle of an enlarger. It covers the range of 0 to 1 minute with a continuously variable, clearly calibrated scale. The timing period is pre-set, and the timing cycle is initiated by depressing the spring-return switch to the "print" position. Front panel provision is made for plugging in the enlarger and a safelight. The safelight is automatically turned "on" when the enlarger is "off". Handles up to 350 watts. The timing cycle is controlled electronically for maximum accuracy and reliability. Very simple to build in only one evening, even by a beginner.

MODEL ET-1
\$11⁵⁰
Shpg. Wt. 3 Lbs.



HEATH COMPANY
A Subsidiary of Daystrom, Inc.
BENTON HARBOR 15, MICH.

COMPREHENSIVE INSTRUCTIONS . . .
 The step-by-step assembly instructions provided with each Heathkit are the finest available anywhere. Each manual begins at the beginning, and assumes no previous training or experience on the part of the kit builder. This means that our kits can be built successfully by anyone who can follow instructions. As a matter of fact, new manuals are tested by having the kit built by someone in our office who has had no previous experience in electronics. This is your guarantee of complete and thorough instruction material.

HEATHKIT HIGH FIDELITY

Preamplifier Kit

- * 5 switch-selected inputs, each with its own level control.
- * Equalization for LP, RIAA, AES, and Early 78's.
- * Separate bass and treble tone controls, and special hum control.
- * Clean, modern lines and satin-gold enamel finish.

Literally thousands of these preamplifiers are in use today, because the kit meets or exceeds specifications for the most rigorous high-fidelity applications, and will do justice to the finest available program sources. Provides a total of 5 inputs, each with individual level controls (three high-level and two low-level). Frequency response is within 1 DB from 25 CPS to 30,000 CPS, or within 1½ DB from 15 CPS to 35,000 CPS. Hum and noise are extremely low, with special balance control for absolute minimum hum level. Tone control provides 18 DB boost and 12 DB cut at 50 CPS, and 15 DB boost and 20 DB cut at 15,000 CPS. Cabinet measures only 12-9/16" W. x 3¾" H. x 4¾" D, and it is finished in beautiful satin-gold enamel. 4-position turnover and 4 position roll-off controls provide "LP," "RIAA," "AES," and "early 78" equalization, and 8, 12, 16, and 1 flat position for roll-off. Derives operating power from the main amplifier, requiring only 6.3 VAC at 1 ampere and 300 VDC at 10 MA. Easy to construct from step-by-step instructions and pictorial diagrams provided.

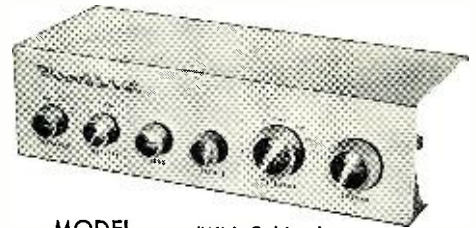

MODEL WA-P2 (With Cabinet) Shpg. Wt. 7 Lbs.

\$19⁷⁵

HEATHKIT HIGH FIDELITY FM TUNER KIT

- * Illuminated slide-rule dial covers 88 to 108 MC.
- * Modern circuit emphasizes sensitivity and stability.
- * Housed in attractive satin-gold cabinet to match WA-P2 and BC-1.

This amazing new FM tuner can provide you with real high-fidelity performance at an unbelievably low price level. Covering 88 to 108 MC, the modern circuit features a stabilized, temperature-compensated, oscillator, A.G.C., broadbanded

IF circuits, and better than 10 UV sensitivity for 20 DB of quieting. A high gain, cascaded, RF amplifier is used ahead of the mixer to increase overall gain and reduce oscillator leakage. It employs a ratio detector for high efficiency without sacrifice in high-fidelity performance. IF and ratio transformers are pre-aligned, as is the front end tuning unit. This means the kit can be constructed by a beginner, without elaborate test and alignment equipment. The FM-3A is designed to match the WA-P2 preamplifier and the BC-1 AM tuner. An illuminated slide-rule dial is employed for frequency indication. Step-by-step instructions and large pictorial diagrams assure success.

MODEL FM-3A
\$25⁹⁵
 INCLUDING NEW EXCISE TAX
 (With Cabinet)
 Shpg. Wt. 7 Lbs.

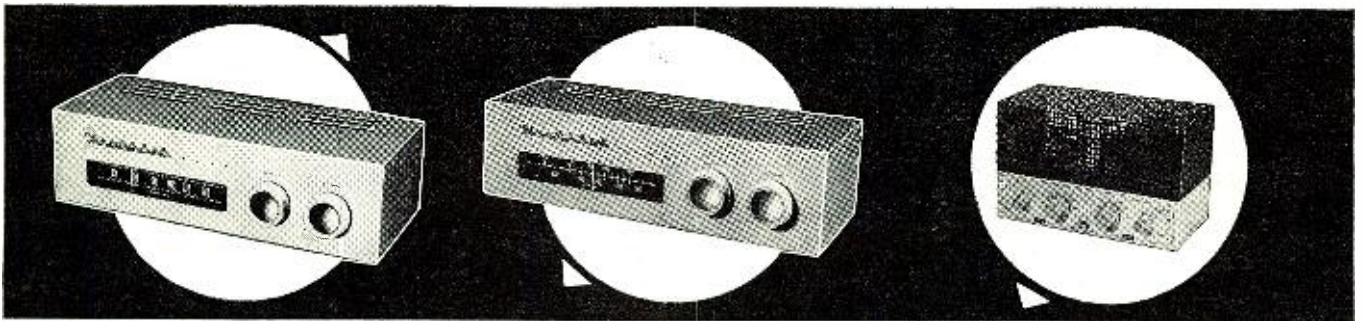

HEATHKIT BROADBAND AM TUNER KIT

This AM tuner has been designed especially for high-fidelity applications. It incorporates a low-distortion detector, a broadband IF, and other features essential to usefulness in high-fidelity. Special voltage-doubler detector employs crystal diodes for low distortion. Sensitivity and selectivity are excellent. Audio response is ± 1 DB from 20 CPS to 2 kc, with 5 DB of pre-emphasis at 10 kc to compensate for station roll-off. Covers the standard broadcast band from 550 to 1600 kc. Incorporates a 10 kc whistle-filter and provides a 6 DB signal-to-noise ratio at 2.5 UV. RF and IF coils are pre-aligned, and power supply is built-in. Incorporates AVC, two outputs, and two antenna inputs.

MODEL BC-1
\$25⁹⁵
 INCLUDING NEW EXCISE TAX
 (With Cabinet)
 Shpg. Wt. 8 Lbs.

HEATHKIT ELECTRONIC CROSS-OVER KIT

This unusual device functions to separate low frequencies and high frequencies so that they may be fed to separate amplifiers and to separate speakers. This eliminates the need for conventional cross-over circuits, since the Model XO-1 does the complete job electronically. Cross-over frequencies of 100, 200, 400, 700, 1,200, 2,000 and 3,500 CPS are selectable with front panel controls on the XO-1, and a separate level control is provided for each channel. Minimizes inter-modulation distortion problems. Handles unlimited power, since frequency division is accomplished ahead of the power stage. Attenuation is 12 DB per octave, with sharp "knee" at cut-off frequency.

MODEL XO-1
\$18⁹⁵
 Shpg. Wt. 6 Lbs.

HEATHKIT ADVANCED-DESIGN



MODEL W-5M
Shpg. Wt. 31 Lbs.
Express Only

\$59⁷⁵

MODEL W-5

Consists of Model W-5M plus Model WA-P2 pre-amplifier.

Shpg. Wt. 38 Lbs.
Express only . . . \$79.50

- * Full 25 watt output with KT-66 output tubes.
- * All connectors brought out to front chassis apron.
- * Protective cover over all above-chassis components.

HEATHKIT DUAL-CHASSIS—WILLIAMSON TYPE HIGH FIDELITY AMPLIFIER KIT

This 20-watt high-fidelity amplifier employs the famous Acro-sound Model TO-300 "ultra-linear" output transformer and uses 5881 output tubes. The power supply is built on a separate chassis, and the two chassis are inter-connected with a power cable. This provides additional flexibility in mounting. Frequency response is ± 1 DB from 6 CPS to 150 kc at 1 watt. Harmonic distortion is only 1% at 21 watts, and 1M distortion is only 1.3% at 20 watts. (60 and 3,000 CPS). Output impedance is 4, 8, or 16 ohms. Hum and noise are 88 DB below 20 watts. A very popular high-fidelity unit employing top-quality components throughout.

MODEL W-3M: Shpg. Wt. 29 Lbs. Express only \$49.75

MODEL W-3: Consists of Model W-3M plus Model WA-P2 pre-amplifier. Shpg. Wt. 37 Lbs. Express only \$69.50

HEATHKIT 7-WATT AMPLIFIER KIT

This amplifier is more limited in power than other Heathkit models, but it still qualifies as a high-fidelity unit, and its performance definitely exceeds that of many so-called "high-fidelity" phonograph amplifiers. Using a tapped-screen output transformer of new design, the Model A-7D provides a frequency response of $\pm 1\frac{1}{2}$ DB from 20 to 20,000 CPS. Total distortion is held to a surprisingly low level. Output stage is push pull, and separate bass and treble tone controls are provided. Shpg. Wt. 10 lbs.

MODEL A-7E: Similar to the A-7D, except that a 12SL7 tube has been added for pre-amplification. Two inputs, RIAA compensation, and extra gain.

MODEL A-7D
\$17⁹⁵

INCLUDING NEW EXCISE TAX

\$19.95⁺

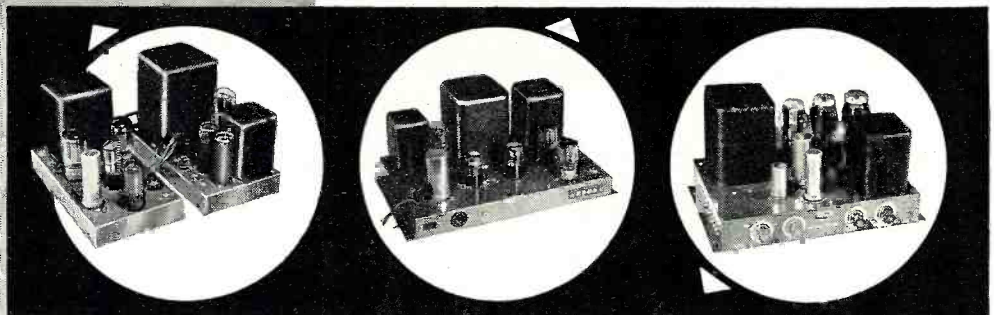

HIGH FIDELITY
Amplifier Kit

This 25 watt unit is our finest high-fidelity amplifier. Using a special design peerless output transformer, and KT-66 output tubes by Genalex, the Model W-5M provides performance characteristics unsurpassed at this price level. Frequency response is ± 1 DB from 5 to 160,000 CPS at 1 watt. Harmonic distortion is less than 1% at 25 watts and 1M distortion is less than 1% at 20 watts (60 and 3,000 CPS, 4 to 1). Hum and noise are 99 DB below 25 watts. Damping factor is 40 to 1. Input voltage for 5 watts output is 1 volt. Tubes employed are a pair of 12AU7's, a pair of KT-66's and a 5R4GY rectifier. Measures 13-3/32" W. x 8 1/2" D. x 8 1/4" H. Output impedance is 4, 8, or 16 ohms. Featured, also, is the "tweeter saver" which suppresses high frequency oscillation, and a new type balancing circuit requiring only a voltmeter for indication. This balance is easier to adjust, and results in a closer "dynamic" balance between output tubes. The Model W-5M provides improved phase shift characteristics, reduced IM and harmonic distortion, and improved frequency response. Conservatively rated high-quality components are used throughout to insure years of trouble-free operation. No technical background or training is required for assembly. Step-by-step instructions are provided for every stage of construction, and large pictorial diagrams illustrate exactly where each wire and component is to be placed. An amplifier for music lovers who can appreciate subtle differences in performance. Just ask the audiophile who owns one!

HEATHKIT SINGLE CHASSIS—WILLIAMSON TYPE HIGH FIDELITY AMPLIFIER KIT

The 20-watt Model W-4AM Williamson type amplifier is a tremendous high-fidelity bargain. Combining the power supply and main amplifier on one chassis, and using a special-design output transformer by Chicago Standard brings you savings without a sacrifice in quality. Employing 5881 output tubes, the frequency response of the W-4AM is ± 1 DB from 10 CPS to 100 kc at 1 watt. Harmonic distortion is only 1.5% at 20 watts. Output impedance is 4, 8, or 16 ohms. Hum and noise are 95 DB below 20 watts.

MODEL W-4AM: Shpg. Wt. 28 Lbs. Express only \$39.75

MODEL W-4A: Consists of Model W-4AM plus Model WA-P2 pre-amplifier. Shpg. Wt. 35 Lbs. Express only \$59.50

HEATHKIT 20-WATT HIGH FIDELITY AMPLIFIER KIT

This high-fidelity amplifier features full 20-watt output using push pull 6L6 tubes. Built-in preamplifier provides 4 separate inputs, selected by a panel-mounted switch. It has separate bass and treble tone controls, each offering 15 DB boost and cut. Output transformer is tapped at 4, 8, 16, and 500 ohms. Designed primarily for home installations, but also used extensively for public address applications. True high-fidelity performance with frequency response of ± 1 DB from 20 CPS to 20,000 CPS. Total harmonic distortion only 1% (at 3 DB below rated output).

MODEL A-9B
\$35⁵⁰

Shpg. Wt. 23 Lbs.



HEATH COMPANY
A Subsidiary of Daystrom, Inc.
BENTON HARBOR 15, MICH.

HEATHKIT HIGH FIDELITY

Range Extending SPEAKER SYSTEM KIT

- * High quality speakers of special design — 15" woofer and compression-type super-tweeter.
- * Easy-to-assemble cabinet of furniture-grade plywood.
- * Attractively styled to fit into any living room. Matches Model SS-1.

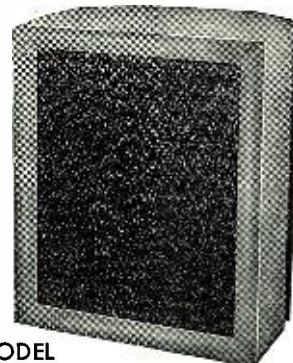

MODEL
SS-1B

\$99⁹⁵

Shpg. Wt. 80 Lbs.

All prices marked with a † include a new federal excise tax that now applies to receivers, tuners and some amplifiers, even though they may be in kit form. Since the tax is in effect as of July 5, 1956, we have no choice but to reflect it in our kit prices. This note is just to let you know we are not increasing our prices on some kits, but merely including this new tax in them.

Thank you,
HEATH COMPANY

This range extending unit is designed especially for use with the Model SS-1 speaker system. It consists of a 15" woofer, providing output between 35 and 600 CPS, and a compression-type super-tweeter that provides output between 4,000 and 16,000 CPS. Cross-over frequencies are 600, 1,600, and 4,000 CPS. The SS-1 provides the mid-range, and the SS-1B extends the coverage at both ends of the spectrum. Together, the two speaker systems provide output from 35 to 16,000 CPS within ± 5 DB. This easy-to-assemble speaker enclosure kit is made of top-quality furniture-grade plywood. All parts are pre-cut and pre-drilled, ready for assembly and the finish of your choice. Complete step-by-step instructions are provided for quick assembly by one not necessarily experienced in woodworking. Coils and capacitors for proper cross-over network are included, as is a balance control for super-tweeter output level. The SS-1 and SS-1B can provide you with unbelievably rich audio reproduction, and yet these units are priced reasonably. The SS-1B measures 29" H. x 23" W. x 17½" D. The speakers are both special-design Jensens, and the power rating is 35 watts. Impedance is 16 ohms.

HEATHKIT HIGH FIDELITY SPEAKER SYSTEM KIT

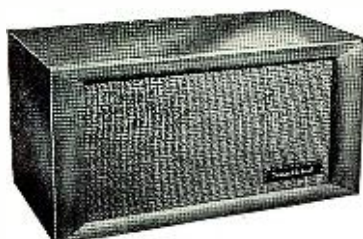

MODEL
SS-1

\$39⁹⁵

Shpg. Wt. 30 Lbs.

- * Special design ducted-port, bass-reflex enclosure.
- * Two separate speakers for high and low frequencies.
- * Kit includes all parts and complete instructions for assembly.

This speaker system is a fine reproducer in its own right, covering 50 to 12,000 CPS within ± 5 DB. However, the story does not end there. Should you desire to expand the system later, the SS-1 is designed to work with the SS-1B range extending unit — providing additional frequency coverage at both ends of the spectrum. It can fulfill your present needs, and still provide for the future. The SS-1 uses two Jensen speakers; an 8" midrange-woofer, and a compression-type tweeter. Cross-over frequency is 1,600 CPS, and the system is rated at 25 watts. Nominal impedance is 16 ohms. The cabinet is a ducted-port bass-reflex type. Attractively styled, the Model SS-1 features a broad "picture-frame" molding that will blend with any room decorating scheme. Pre-cut and pre-drilled wood parts are of furniture grade plywood. The kit is easy-to-build, and all component parts are included, along with complete step-by-step instructions for assembly. Can be built in just one evening, and will provide you with many years of listening enjoyment thereafter.

HEATH COMPANY A Subsidiary of Daystrom, Inc. BENTON HARBOR 15, MICH.

ORDER BLANK

NOTE: All prices subject to change without notice.

Enclosed find () check () money order for _____
Please ship C.O.D. () postage enclosed for _____ pounds.

On Express orders do not include transportation charges — they will be collected by the express agency at time of delivery.

ON PARCEL-POST ORDERS include postage for weight shown. ORDERS FROM CANADA and APO'S must include full remittance.

Name _____

Address _____

City & Zone _____ State _____

(PLEASE PRINT)

SHIP VIA

- Parcel Post
- Express
- Freight
- Best Way

QUANTITY	ITEM	MODEL NO.	PRICE

**"CODDLE"
YOUR
CUSTOMERS**

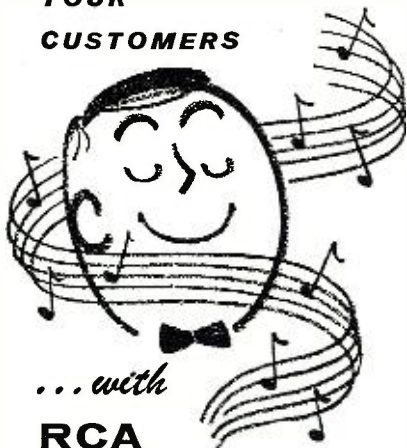

...with
**RCA
GOLD LABEL
SPEAKERS**



Your customers' satisfaction is assured . . . your servicing jobs are easier . . . when you install RCA Gold Label Speakers. All types are built to meet RETMA specifications, and mounting hardware is included with most of the small sizes. Next time you buy, specify RCA Gold Label Speakers—you'll like 'em!



**RADIO CORPORATION
of AMERICA**

COMPONENTS DIVISION CAMDEN, N.J.

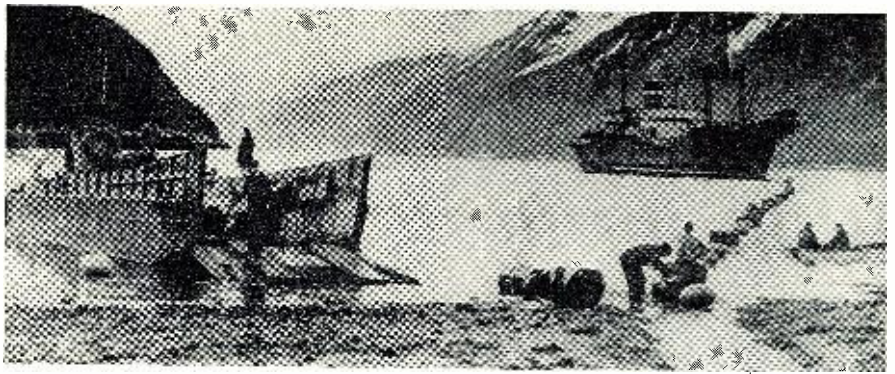

Beach landing of cable at Skagway, Alaska. The cable from the bow of the cable-ship Albert J. Myer, in background, is supported by means of drums and balloons.

Alaska Telephone Cable Opened for Use

Underwater cable handles 36 conversations at once, provides added circuits for public and defense needs.

THE U. S. Army Signal Corps and the Bell Telephone System opened to public service a new and important communications link between the United States and the growing Territory of Alaska. The link consists of an underwater telephone cable system stretching some 1250 miles from Port Angeles, Washington, to Skagway, Alaska.

The cable system represents two major projects, costing a total of 20 million dollars—one provided by the Long Lines Dept. of A. T. & T.; the other by the Alaska Communication System, which is operated by the Signal Corps. The A. T. & T. cable system extends from Port Angeles to Ketchikan, Alaska, a distance of about 900 miles. Twin cables, containing built-in amplifiers, lie in the ocean depths off the coast between the two points. These cables were placed by the cable-ship Albert J. Myer late last year.

The ACS cable, which covers the

400 miles between Ketchikan and Skagway, is a single submarine cable stretching along the inland waterway on the southern coast of Alaska. This cable utilizes amplifying stations that are located on islands or points of land that dot that area.

From Port Angeles, the southern terminal, the cable circuits are connected to the U. S. network at Seattle by a radio relay link recently constructed by the Pacific Telephone and Telegraph Co. At the northern end, beyond Skagway, the circuits are fed into the Alaska communications network, operated by ACS.

The system took over two years to build. It can carry 36 conversations at one time and will be used to supplement the radiotelephone and land line facilities that have been operating between the States and Alaska since 1937. The new cable system will more than double the capacity of present radio and land line circuits. —30—

Map shows route of new telephone cable. Total length is about 1250 statute miles.

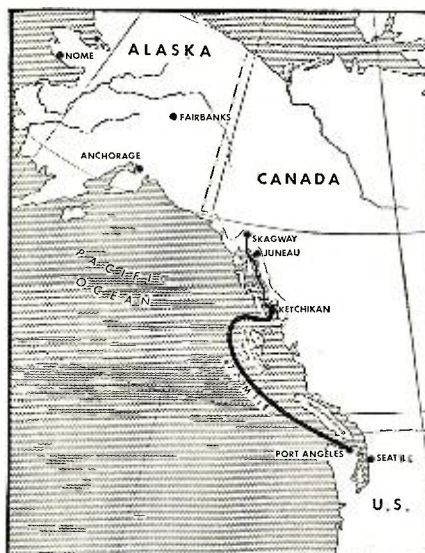

Men loading cable into one of four vast storage tanks below deck of the cable-ship.



Before You Call for Service
(Continued from page 37)

damping material such as sponge rubber cushioning.

7. *Hum*: Hum can be due to a variety of causes. It may be that the filter circuits in the power supply used for one or more of the components in the system have deteriorated. This can be checked by the volume control and program switching method described at the beginning.

However, hum can also be due either to open ground connections or to a ground loop. If, for example, the hum only appears when the pickup lead is plugged into the preamplifier (but it never used to), the fault is probably in the pickup or turntable assembly. Either the pickup provides a ground and there is an additional ground connection on the motor, making two grounds between the phono assembly and the amplifier; or else the shielding of the pickup lead may have become open circuited so the ground connection depends upon a kind of capacitance effect through the motor. Either of these faults will produce greater hum when the pickup is connected to the preamplifier.

Check the circuit thoroughly to see that the shielding has not broken apart somewhere in the input connection, that one of the input leads has not broken, or that the insulation has not frayed away, allowing the shielding to come in contact with a ground point where it should not.

This kind of fault can be quite time consuming to find and it might as well be your time (for which you don't pay) as the local service technician's. If the fault is not something that is as readily traceable as this, best turn the equipment over to him and let him trace it.

Sometimes hum can be eliminated by the simple expedient of reversing the power plug, or that of one unit. This is always worth trying, but with good equipment does not usually make much difference.

Using the checks described in this article, you will be able to find which piece of equipment is responsible for the trouble, and will be able to give the service technician some idea of the fault to track down. This will mean that he need not take the whole system for test—just the defective component. He will also have a good idea what he is looking for, which the man given the problem at the beginning could not have. By making checks like this, *before you call for service*, your service technician will be able to give you much more efficient service. You will not be confronted later by what appears to be an exorbitant charge for a very small amount of work, merely because the technician had to spend an unconscionable time locating the trouble. This way you will be money in pocket and the service technician will be happier about the job he does for you.

-30-



MODEL 125 — ABSOLUTE DEPENDABILITY AND POWER FOR EVERY APPLICATION

NEW! 125 WATTS!

Power For EVERY Purpose

THE FISHER MODEL 125 AMPLIFIER

WITH the introduction of the magnificent, new FISHER Model 125 and its companion, the FISHER Model 55-A, the discriminating user can now select a quality amplifier that will meet his *every* need now, or in the future — on the score of ample *reserve* power and quality reproduction.

OUTSTANDING SPECIFICATIONS

THE FISHER MODEL 125

- Less than 0.6% distortion at 125 watts.
- Less than 1% IM distortion at 100 watts.
- Frequency response ± 0.1 db 20-20,000 cycles.
- Hum and noise better than 92 db below full output.
- Two power supplies.
- Exclusive FISHER Performance Monitor Meter.
- 8 and 16 ohm output impedances.
- SIZE: 14" x 11 $\frac{1}{4}$ " x 8 $\frac{1}{4}$ " high.

Price **\$229.50**

THE FISHER MODEL 55-A

- Less than 1% distortion at 55 watts.
- Frequency response ± 0.1 db from 20-20,000 cycles.
- Hum and noise better than 92 db below full output.
- Exclusive FISHER Performance Monitor shows correct adjustment of tube bias and indicates average power output.
- 8 and 16 ohm speaker output impedances.
- SIZE: 14 $\frac{1}{4}$ " wide x 9 $\frac{3}{4}$ " deep x 8-3/16" high.

Price **\$169.50**

MODEL 55-A • LABORATORY STANDARD AMPLIFIER

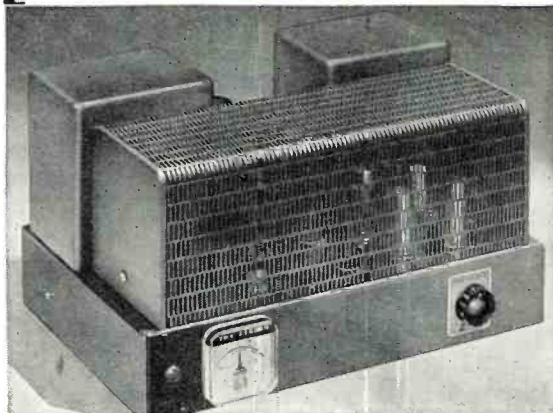

MODEL 55-A

55 WATTS

Write For **FULL** Details
FISHER RADIO
21-23 44th DRIVE
Long Island City 1, N. Y.

**avoid
a costly
mistake**

**in your
high fidelity system**

turntable
or
record
changer...
which
shall
I buy?

**send for this new
REK-O-KUT booklet**

*colorfully illustrates...
factually describes... the
important advantages of
playing your records on a
precision turntable!*

FREE — SEND COUPON TODAY!

NAME _____
ADDRESS _____
CITY _____ ZONE _____ STATE _____

REK-O-KUT COMPANY, INC.
38-01 Queens Blvd.
Long Island City 1, N. Y. TN



New Hi-Fi-Audio

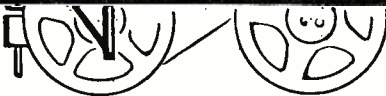

Equipment

NEW FISHER FM TUNER

Fisher Radio Corporation, 21-21 44th Drive, Long Island City 1, N. Y., has begun the distribution of its latest FM tuner, the Model FM-90.

Completely new in circuit design and appearance, the new unit uses a

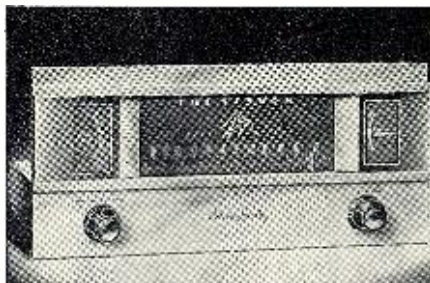

full wideband detector in addition to the company's exclusive "Dual Dynamic" limiters to give complete AM noise rejection. These dynamic limiters are in full operation at all times, irrespective of signal strength. These limiters completely reject noise and interference caused by automobile or oil burner ignition systems, household appliances, etc.

The tuner incorporates two meters for microaccurate tuning; one indicates signal strength and the second shows center-of-the-channel. The FM-90 is available in either blonde or mahogany finished cabinets. An additional charge is made for the light finish.

REDESIGNED MICROPHONES

Shure Brothers, Inc., 222 Hartrey Ave., Evanston, Ill., has announced an improvement in its "Unidyne" microphone which provides 40 per-cent higher output over previous models.

This mike unit is especially designed for quality p.a. system work, low-gain p.a. setups, and tape recorders. The company or any of its authorized distributors will supply full details on request.

"PILOTONE" AMPLIFIER

Pilot Radio Corporation, 37-06 Thirty-Sixth St., Long Island City 1, N. Y., is now offering a new 14-watt "Williamson-type" amplifier-preamp as its Model AA-903B.

The circuit incorporates two EL84 tubes in a Williamson-type circuit which provides 14 watts of undistorted power with a peak power of 28 watts and extremely low IM and harmonic distortion. Hum and noise levels are low since a d.c. filament supply is used for the preamp tubes. Frequency response is ± 1 db from 20 to 20,000 cps.

A master level setting control and a loudness control with Fletcher-Munson characteristics are also included. The selector switch permits choosing a signal from any one of five playback equalizers.

The company will supply a comprehensive data sheet on this new equipment on request.

REAR SEAT SPEAKERS

Empire Electronics, Inc., 22022 Woodward Ave., Detroit 20, Mich., is now in production on a new type of rear seat speaker which has been tradenamed the "Car-Fi."

Although originally designed and engineered for station wagons, the unit can be used with any auto body model. The speaker is finished in ivory and gold and measures 6" x 9". It may be

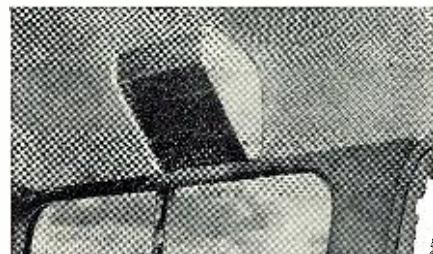

quickly installed without cutting holes and comes complete with an installation kit.

For full information on this product and prices, write Walter O. Davey, sales manager of the firm.

MATCHED SYSTEM ENCLOSURES

The *Cabinart Division* of *G & H Wood Products Company*, 99 N. 11th St., Brooklyn, N. Y., is now offering a pair of matched cabinets which will

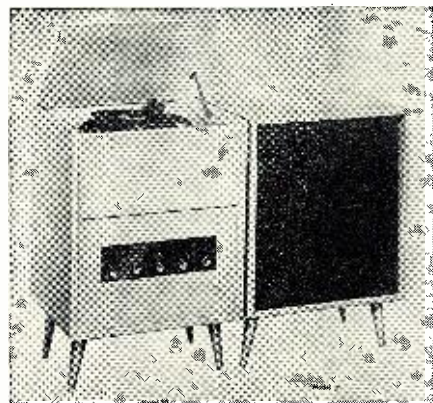

house a complete high-fidelity sound system.

The Model 30 is a lift-top equipment cabinet featuring two compart-

RADIO & TELEVISION NEWS

ments. The upper player compartment measures 19½" wide and 14½" deep with the height above the player board 6". The lower compartment, for the tuner and/or amplifier, is 13" high, 19½" wide, and 14½" deep. The equipment panel may be removed and this compartment used for storage. The cabinet is available finished or unfinished.

The matching bass-reflex enclosure, Model 31, measures 4.5 cubic feet. Like the equipment cabinet it stands 32" high including legs. Each model measures 21" wide and 16" deep.

Write the manufacturer for prices on these and other enclosures in its line.

IMPEDANCE MATCHING PREAMP

Madison Fielding Corp., 863 Madison St., Brooklyn, N. Y., is now in production on an all-transistorized,



impedance-matching preamp unit which permits the direct use of low-impedance, low-gain cartridges and microphones with high-impedance tape recorders, amplifiers, p.a. systems, etc.

Known as the "Micamp," the new unit provides more than 30 db gain with no hum pickup and no distortion at normal levels. Frequency response within 1.5 db from 20 to 20,000 cps is thus assured.

When used with low-impedance, low-gain cartridges, the new unit provides full gain without hum or distortion over the full sonic range without the use of a matching transformer. Likewise its use permits low-level crystal microphones to be used with high-impedance tape recorders without impairing the hi-fi qualities of the recorder.

The manufacturer will supply complete specifications on the preamp upon request.

TRANSISTORIZED RECORDER

The Theatre and Sound Products Department of Radio Corporation of America, Camden, N. J., is now marketing a professional-quality magnetic tape recorder which incorporates transistors, printed circuitry, and electrodynamic operation.

The SRT-2 is a tape recorder-reproducer chassis designed for easy installation in home-assembled hi-fi music systems and industrial sound systems. The unit is virtually non-microphonic and hum free; the use of printed circuitry is said to assure maximum design uniformity and operating precision of electronic circuits;

March, 1957

BEST BUY IN HI-FI
Premier

THE Grommes 212

New deluxe Equalizer Pre-amplifier Control Center designed for those who want the ultimate in high fidelity. Self powered with DC filaments for use with any high quality basic power amplifier. Now, extreme flexibility can be yours with 13 front panel controls. Check these exclusive features: 6 position separate turnover and roll-off record compensators, calibrated bass and treble controls with true flat positions, presence control, low frequency balance control for boosting the lower bass range, feedback around each stage, and 8 inputs which include 2 phono channels and equalized tape head input. The 212 together with the Grommes 260 basic amplifier make the finest combination obtainable. Frequency Response: ±0.1DB, 10 to 20,000 CPS. Distortion: 0.5% harmonic and 0.1% intermodulation at 10V. output. Finish: Charcoal Gray and Brass. For tabletop or cabinet installation. Size: 12¾" W x 4" H x 7" D. Shpg. Wt. 12 lbs. Net. 129.50

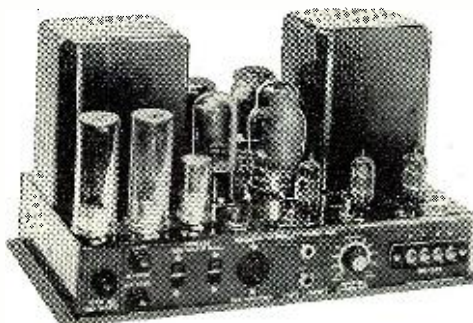

**BEST BUY
IN HI-FI**

**GROMMES
Premier 260**

New 60 Watt Hi-Fi Basic Amplifier. Designed for the very finest Hi-Fi system. New advanced circuitry with stability built around an Ultra-Linear output stage gives performance far superior to ordinary power amplifiers. Circuit features direct coupling; cathode coupled phase inverter; feedback cathode follower drivers and push pull 6550 tubes with fixed bias. Output transformer is special design tapped screen type. Power: 60 watts, with 120 watts peak. Distortion: 0.25% harmonic and 0.5% intermodulation at 60 watts (all distortions under 0.1% at 20 watt level or less). Frequency Response: ±.5DB, 5 to 50,000 CPS (Attenuated beyond 1,000,000 CPS). Power Response: ±.5DB, 20 to 20,000 CPS. at 60 watts. Premier fidelity assured when combined with the Grommes 212. Size: 14" W x 8¼" H x 8" D. Shpg. Wt. 40 lbs. Net. 169.50

Ask your Hi-Fi Dealer to demonstrate the Best Buy in Hi-Fi, the Grommes Premier Line. And be sure you see the complete new line of Grommes High Fidelity Amplifiers, the 10PG, 15PG and the 20PG. If your Dealer cannot help you, write

Grommes

DIV. OF PRECISION ELECTRONICS, INC.

Dept. R-3, 9101 King St., Franklin Park, Illinois

Send Free Hi-Fi Equipment Brochure

Name _____

Address _____

City _____ Zone _____ State _____

your present
speaker
in a
**KARLSON
TRANSDUCER**



**CAN GIVE YOU
10x THE EFFICIENCY**

2x the dispersion!
2 more octaves bass!
Flatter response — Less distortion!
Unexcelled transient response!

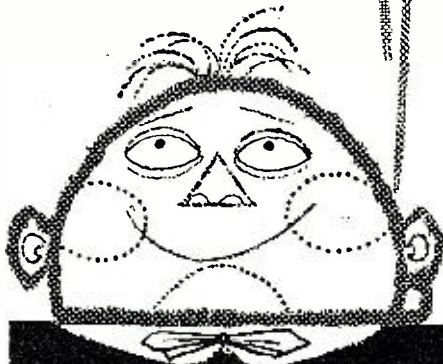

IN EASY-TO-ASSEMBLE

K I T S

Hardwood exteriors - capable
of fine furniture finish -
from \$18.60 to \$57 net.

Also assembled models from \$26.70 to \$174.

See Your Dealer or Write:

KARLSON ASSOCIATES INC.

Dept. RTN

1610 Neck Rd. Bklyn. 29, N. Y.

and operates with a minimum of moving parts. The application of electro-dynamic control to speed-changing and directional function makes prac-



tical the elimination of belts, clutches, brakes, and other moving parts normally required.

Full specifications are available from the company's distributors or from the manufacturer direct.

EQUALIZER-PREAMP

Hermon Hosmer Scott, Inc., 385 Putnam Ave., Cambridge 39, Mass., is now offering a new version of its "Dynaural" equalizer-preamp as the Type 121-C.

The new instrument has provision for two magnetic inputs; a completely new "Dynaural" dynamic noise sup-

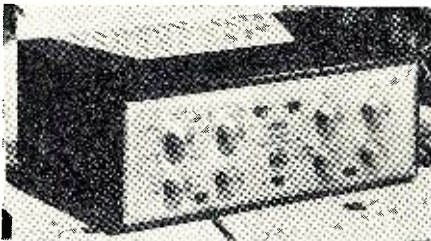

pressor with switchable dynamic rumble filter that allows scratch suppression only, rumble suppression only, or both; new improved facilities for tape recording; switch for instantaneous monitoring off the tape with three-head recorders; and brand new construction for easy panel mounting. A case is available as an accessory for using the unit on a table or bookcase.

Write the manufacturer for complete electrical specifications on this equipment.

TRANSCRIPTION PLAYER

David Bogen Co., Inc., P. O. Box 500, Paramus, N. J., is now offering its Model B50-16 transcription player for high-fidelity system applications.

The new unit is manually operated and will play all discs up to 16" in diameter at all four speeds (78, 45, 33½, and 16, talking book, rpm) or at any other desired speed from 29 to 86 rpm.

The speed is regulated by means of a single control. A heavy-duty, four-pole constant velocity motor and a weighted balanced turntable 11¾" in diameter reduce wow to less than .5 per cent and keep hum and rumble at similarly negligible levels. The turntable is covered with a serrated rubber pad and the stylus pressure is adjustable to

**IT'S THE BEST...
AN ULTRA-LINEAR**

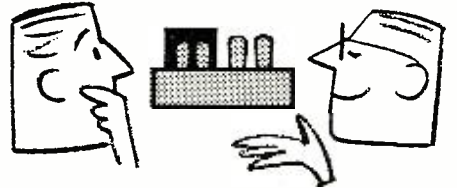

The circuit that is used in more and more amplifiers to insure high power and excellent stability with minimum distortion. Ultra-Linear is the ultimate in high fidelity reproduction, but . . .

**ARE YOU SURE
IT'S ULTRA-LINEAR?**

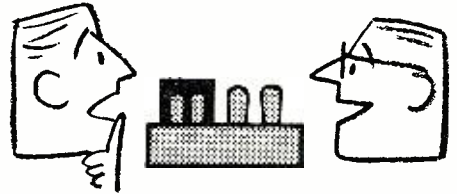

Many manufacturers are claiming Ultra-Linear operation of their amplifiers, even showing a screen tapped output transformer in the schematic as proof . . . but this does not guarantee Ultra-Linear performance.

**HERE'S HOW
YOU CAN TELL**



Look for the black and gold "K" symbol showing that the amplifier is a "Licensed Ultra-Linear." This circuit . . . covered by patent* . . . is specifically designed to provide minimum distortion at both high and low levels, high efficiency and good damping. The optimum conditions can be obtained only when the output transformer is topped within a specific range for the output tubes . . . pentodes or triodes . . . used in the circuit. If the transformer is topped outside of the specified range, it is not Ultra-Linear, nor can it be claimed as such. The "K" symbol then is your guarantee of true Ultra-Linear performance.

**Get the full story on
ULTRA-LINEAR**

. . . from
*KEROES ENTERPRISES
owner of U.S. Pat. No. 2,710,312

ACRO PRODUCTS CO.
Sole Licensing Agent

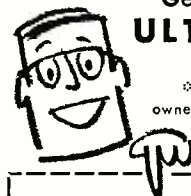

Acro Products, 369 Shurs Lane, Phila. 28, Pa.

I am enclosing 25c for your new booklet "Theory and Operation of the Ultra-Linear Circuit."

Name
Address
City State

RADIO & TELEVISION NEWS

assure minimum record wear. "Feather drop" action of the pickup arm eliminates the possibility of damage to stylus or record.

The arm is equipped with a plug-in head for ease in changing cartridge



and styli. Each player is supplied with vibration isolators. Either piezoelectric dual sapphire-tipped styli or the G-E variable reluctance magnetic cartridge with dual reversible styli are supplied with the player.

NEW TAPE CARTRIDGES

Cousino, Inc., 2107 Ashland Ave., Toledo 2, Ohio, has recently developed a new long-play, tamper-proof, self-threading tape cartridge which will provide over one hour of recording time.

The new unit is completely compatible with the standards already established by the half-hour "Echo-Matic" cartridge introduced last year. Thread-

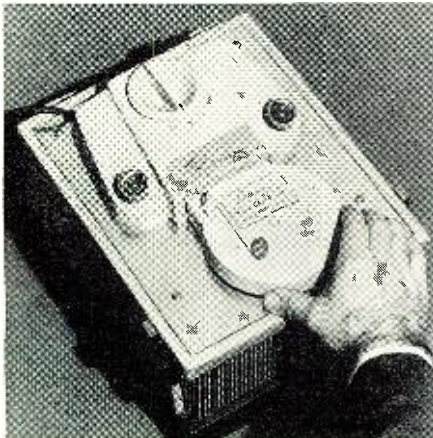

ing is accomplished automatically by the simple action of pushing the cartridge forward into the playing slot. The cartridge is ejected automatically with the tape rewound ready for the next play and retracted to avoid tangles or tampering.

The special "friction free" unbreakable tape and splice provides for years of continuous trouble-free operation, according to the company. The recordings in the cartridge can be erased and re-recorded at will, just as with conventional recorders and reels.

FILTER DESIGN KIT

Torocoil Company, 2615 Bristol Road, Columbus 21, Ohio, has released a new audio filter designers' kit which has been tradenamed "Filtor-pac."

The kit offers the user detailed filter data and know-how as well as a set of eighteen high "Q" toroidal inductors which can be quickly assembled into all combinations of high, low, and bandpass or rejection filters. The unit

March, 1957

Twelve Years of Superiority

The Altec 604 Duplex®

Since its introduction in 1945 the Altec 604 coaxial loudspeaker has been considered the finest single frame loudspeaker in the world. The 604 Duplex has become the quality listening standard in the majority of recording studios and broadcast stations. And, since the beginning of the home high fidelity market, it has led the field in popular acceptance. More than 95% of all the 604 Duplexes built are still in service today.

The reasons for the marked superiority of the speaker are surprisingly simple. Conceived originally as a professional quality standard, the 604 was designed in a straight-forward manner and at the time of its introduction incorporated many features new to the industry. Continuing research has resulted in the constant improvement of this speaker, but it is interesting to note that the basic design features have not yet been changed; the 604 remains superior and many of the features built into the 604 more than 12 years ago are now being promoted in the high fidelity industry as "new developments" and "industry firsts."

Let's examine the 604C Duplex in detail, analyzing the design features which have made it famous.

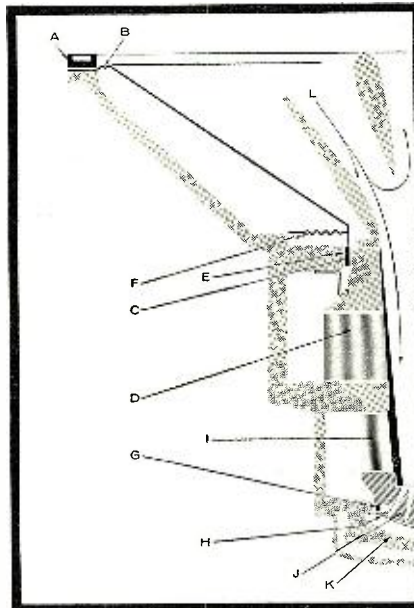

BASS SECTION

(a) The outer edge of the loudspeaker cone is clamped between the cast frame and rigid cast clamping ring, instead of the more common glued construction. This clamping ring permits more accurate centering of the cone and assures its accurate location over a long period. (b) The compliance section of the cone is provided with a viscous anti-reflecting compliance damping to absorb sound waves which would introduce distortion if permitted to reflect back down the cone. (c) The three inch voice-coil is made of 95 turns of ribbon copper wire, wound on edge to provide greater speaker efficiency. The ribbon is .0033" thick and .024" wide and is coated with two .00025" layers of insulation for protection against electrical shorting between turns of the coil. (d) A 4.4 pound Alnico V ring magnet provides high efficiency and precise control over the movement of the speaker cone. (e) The deep voice-coil gap sides provide a long path of homogeneous flux density permitting greater cone excursion (.75") while maintaining the voice-coil in a constant flux field. The use of a shallow gap would mean that the voice-coil would move to areas of varying flux density with resulting distortion. (f) The woven annular compliance spider and damped cone compliance (b) permit free cone excursion for a maximum natural cone resonance of 40 cycles while at the same time controlling the cone movement to avoid acoustic self resonances.

TREBLE SECTION

(g) The 1.75 inch voice-coil consists of 37 turns of double insulated edge wound aluminum ribbon .0023" thick and .014" wide for maximum efficiency. (h) The domed diaphragm is made of an exclusive fatigue resistant aluminum alloy for long life and high rigidity. To provide the lowest possible mass an integral tangential compliance is formed of the same material. (i) A 1.2 pound Alnico V ring magnet physically separated from the low frequency structure. (j) A dual-annular phasing plug automatically machined to assure complete production accuracy. (k) A mechano-acoustic loading cap to provide proper back loading of the aluminum diaphragm. (l) A true exponential throat ending in six exponential horns grouped in a 2x3 multicellular configuration to provide a 40° by 90° distribution pattern. It should be noted that the exponential horn both in its sectoral and multicellular shapes is still the only type of high frequency horn which has proved acceptable in professional use.



The 604C including network \$165.00

As you can see, the Altec 604 Duplex was a truly revolutionary development 12 years ago and today, with its many improvements, still displays a marked degree of engineering superiority and a performance throughout the entire range from 30 to 22,000 cycles noticeably superior to that of any other single frame loudspeaker.

If you are not as yet acquainted with the superb performance of Altec Duplex loudspeakers, ask your dealer for a listening comparison with any other units. We are sure you will hear the superiority that has made the Duplex famous for 12 years.



Dept. 3-TM

1515 S. Manchester Ave., Anaheim, Calif.
161 Sixth Avenue, New York 13, New York

Introducing



**DUOTONE
FIDELITY
FOCUS
Loudspeakers**

New Engineering Technique Assures You—
Bell-Clear Highs; Vibrant-Undistorted Lows.

DUOTONE—For a quarter of a century, leader in the high fidelity industry, presents for the first time, **DFF, DUOTONE FIDELITY FOCUS LOUDSPEAKERS**. A new high in manufacturing standards and procedures assures you of a superb quality seldom found in most other loudspeakers. Rigid specifications adhered to and exacting field trials were made before this fine line was presented to the public. It was only the results of these exhaustive tests that assured us of a product worthy of the HI-FI enthusiasts interests. Whether you choose a coaxial speaker such as the Royal or Medalion, or a woofer-tweeter combination like the Supreme and the Duchess, you will be more than satisfied with the excellent response these speakers afford. Stop into your HI-FI dealer's showroom and ask to hear them. Your reward will be the self-satisfaction of hearing excellent high fidelity sound reproduction. There's a **DUOTONE FIDELITY FOCUS LOUDSPEAKER** to match your system and they are priced to \$53.97.

Write today for our **FREE** new booklet, "An Objective Study of Loudspeakers". It's designed to help you choose and install your speaker system.

12 in. Coaxial
Cat. No. 12CX-62
35 to 18,000
cps. Power:
25 watts Imp:
8 Ω



The ROYAL

12 in. Coaxial
Cat. No. 12CX-60
35 to 18,000
cps. Power:
15 watts Imp:
8 Ω



The MEDALION

8 in. Coaxial
Cat. No. 8CX-50
50 to 20,000
cps. Power:
10 watts Imp:
8 Ω



The MARQUIS

8 in. Coaxial
Cat. No. 8CX-70
75 to 19,000
cps. Power:
6 watts Imp:
8 Ω



The VISCOUNT

4 in. Tweeter
Cat. No. 4TX
1000 cycles to
beyond aud.
Power: 5 watts
Imp: 8 Ω



The DUKE

7 in. Tweeter
Cat. No. 7TX
350 cycles to
beyond aud.
Power: 10 watts
Imp: 8 Ω



The DUCHESS



consists of complete design information and measurement technique suggestions including graphs, formulas,

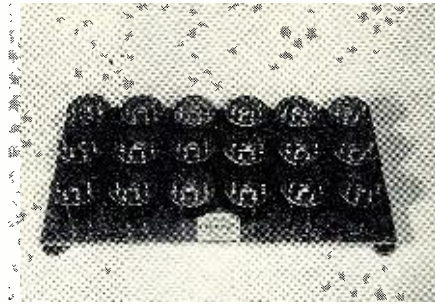

and typical examples as well as the set of multi-valued toroidally wound Permalloy dust core inductors. The inductors are plastic encased for ruggedness and provided with single-screw mounting and turret terminals for maximum convenience in rapid assembly and disassembly of test setups.

Write the manufacturer for full details on this kit.

"STROBESELECTOR"

The Califone Corporation, 1041 N. Sycamore Ave., Hollywood 38, Calif., has added its new "Strobeselector" variable speed control to many of its 1957 model phonographs and sound systems.

The control makes possible not only an immediate selection of any desired speed from 16 to 84 rpm at the turn

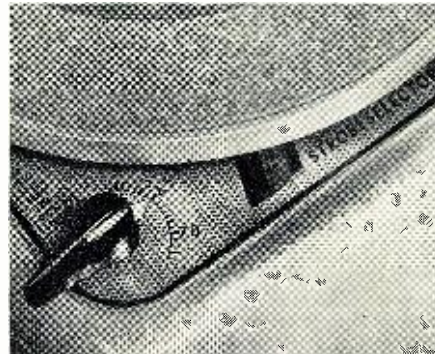

of a single knob, but also exact setting at the standard 16 $\frac{2}{3}$ (talking book), 33 $\frac{1}{3}$, 45, and 78 rpm speeds. The new unit consists of a full vision control and a stroboscope window which becomes illuminated when the phonograph power is on. The arrow indicates the desired speed on a graduated scale which has the standard speeds printed on it. Strobe lines for each of the four speeds are plainly marked and when the lines are motionless, the exact speed is insured.

PRESTO TURNTABLE

Presto Recording Corp., Box 500, Paramus, N. J., is now offering its new "Promenade" turntable to audiophiles.

Featuring a precision-machined 12" turntable which will handle 33 $\frac{1}{3}$ and 45 rpm speeds, the new unit incorporates a heavy-duty motor which insures accuracy of speed. The three-idler drive system minimizes wear.

The permanent 45 rpm adapter retracts under the turntable when not

in use. The Model T-2 operates on 110 volt, 60 cycle a.c. but is available on special order for 50 cycle and/or 220 volt operation. Write the company for full details.

"MULTI-TALK" INTERCOM

Mark Simpson Mfg. Co., Inc., 28 49th St., Long Island City 3, N. Y., is now marketing a new "Multi-Talk" intercom which permits communication between rooms as well as between master and remote stations.

Designed for household applications, the intercom can also be used as a music distribution system by plugging in any radio, phonograph, recorder, or record changer. A flush-mount

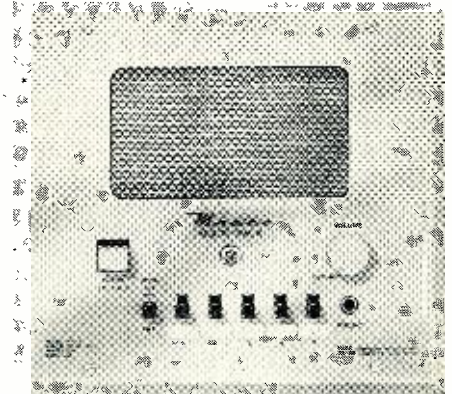

radio or a portable radio can be installed as additional equipment.

The new intercom is finished in gold, copper, or stainless steel and is of modern design which fits most decorating schemes.

AUDIO CATALOGUES

"BAFFLES UNBAFFLED"

Rockbar Corp., 650 Halstead Ave., Mamaroneck, N. Y., is now offering a new pamphlet of interest to audiophiles.

Entitled "Baffles Unbaffled," the material is a reprint of articles by E. J. Jordan, chief engineer of *Goodmans Industries, Ltd.*, which originally appeared in *Audio Magazine*. Highlight of the articles is a complete mathematical and acoustical evaluation of the *Goodmans' ARU* unit.

Free copies of this pamphlet, of interest to electronic, radio, and acoustic engineers as well as advanced audiophiles, are available on request.

FREE HI-FI BOOKLET

H. H. Scott, Inc., 385 Putnam Ave., Cambridge, Mass., has published a free illustrated booklet which explains hi-fi in simple non-technical language.

This color booklet contains a "question and answer" section that explains in concise, non-technical language what component high fidelity is, the advantages of a component system, and the function of each component. In addition, there is a handy high-fidelity planning guide.

Complete specifications on all of the company's new components are included with concise explanations of engineering features. Photos show typical installations.

The company will forward a free copy of this booklet to those writing for it to Department NR 12.

REPLACEMENT NEEDLES

Recoton Corporation, 52-35 Barnett Ave., Long Island City 4, N. Y., has just released copies of the Sixth Edition of its "Simplified Replacement Needle Reference Guide."

As with the previous editions of this guide, a simple numbering system permits easy selection of the right needle for any phono system. A cover chart pictures 168 needle types and can be used for comparison and identification if the customer brings in an old needle. The sections within the guide are set up in tabular form for ready reference.

Copies of this publication are priced at \$2.50 each and are obtainable direct from the manufacturer.

BOZAK EQUIPMENT

The R. T. Bozak Sales Company, Box 966, Darien, Conn., has just issued a new 8-page catalogue covering its line of speaker systems, speakers, crossover networks, and panel-mounted systems.

In addition to supplying complete specifications, both mechanical and electrical, on all the units, the catalogue pictures the items and carries a two-page discussion of the philosophy behind the designing of these audio units.

Copies of this catalogue are available without charge from the company.

CARTRIDGE BOOKLET

Fairchild Recording Equipment Company, 10-40 45th Ave., Long Island City 1, N. Y., has published an interesting and informative booklet on cartridges entitled "In the Groove."

The booklet contains basic design data on various popular types of cartridges and explains in simple terms how they are constructed and operate. Free copies are available from the manufacturer.

LOOK!

A General Electric GERMANIUM RECTIFIER specifically designed for TV replacements

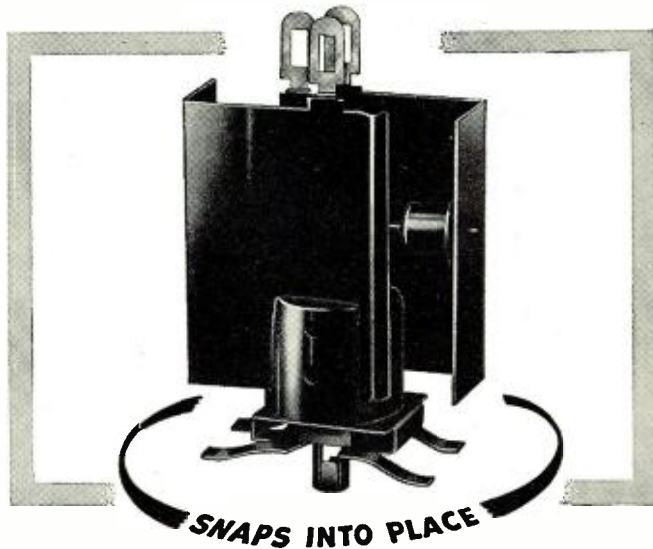

- ★ Snap-In Installation
- ★ Competitively Priced
- ★ Full Year's Written Warranty
- ★ Full Power Performance—no aging or fading

TV servicemen in the know are surging to General Electric's *proved* Germanium Rectifier. It's the new rectifier that goes in faster and easier, sustains full power and just about ends return calls on voltage troubles.

General Electric Germanium Rectifiers are backed by a record of more than six years of successful service in the field. The performance of these TV rectifiers has been checked in current television chassis by a leading independent testing organization.

Your outstanding advantage in General Electric Germanium Rectifiers is the ease of installation. They snap into place—faster than the old one comes out. No brackets to add, no drilling, reaming, or tapping to make them fit. And you don't have to install "heavy duty" or super-rated rectifiers to make sure of adequate voltage six months or a year later.

FREE... REPLACEMENT GUIDE

The General Electric Germanium TV Rectifier REPLACEMENT GUIDE tells you exactly which model fits your customer's set, and contains other useful data. Get your copy, free...at your G-E tube distributor now. Or, write directly to *General Electric Company, Semiconductor Products, Section S5837, Syracuse, New York.*

Progress Is Our Most Important Product

GENERAL ELECTRIC

build
your own
amateur
transmitter



VIKING "ADVENTURER"—An ideal 50 watt CW transmitter for the novice or experienced amateur. Effectively TVI suppressed... built-in power supply... bandswitching 80 through 10 meters Easy to build and safe to operate. Complete with tubes, less crystal and key.
Cat. No. 240-181 Kit..... Amateur Net \$54.95



from these
3 easy-to-assemble
kits!



VIKING "RANGER"—Tops for operating convenience—enough power for world-wide contacts! Built-in VFO or may be crystal controlled. Bandswitching 160 thru 10 meters. 75 watts CW input—65 watts phone. TVI suppressed—with tubes, less crystals, key, microphone.
Cat. No. 240-161-1 Kit... Amateur Net \$214.50
Cat. No. 240-161-2 Wired. Amateur Net \$293.00

from these
3 easy-to-assemble
kits!



VIKING "VALIANT"—275 watts CW and 558 (P.E.P. input with auxiliary 558 exciter) 200 watts phone! Bandswitching 160 thru 10 meters. Built-in VFO or crystal control. Wide range pi-network output—TVI suppressed—high gain push-to-talk audio system. With tubes, less crystals, key and microphone.
Cat. No. 240-104-1 Kit... Amateur Net \$349.50
Cat. No. 240-104-2 Wired. Amateur Net \$439.50

FREE CATALOG!
Write today for your copy!



E. F. Johnson Company
3107 SECOND AVE. S.W. • WASECA, MINN.

Pilot

"all-in-one"

HIGH FIDELITY

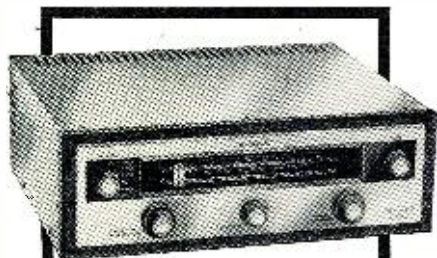

HF-42

\$199⁵⁰

slightly higher
West of Rockies

All Components in One Handsome Enclosure finished in burnished brass and contrasting burgundy trim. The perfect unit for open shelf or table top use.

- FM-AM Tuner with New Beacon Tuning
- Phono & Tape Head Preamp
- 20-Watt Amplifier

Ready to plug-in and use with any speaker system

PILOT RADIO CORP.

Dept. MC-437-06 36th St., L.I.C. 1, N.Y.
Please send complete details about the HF-42.

NAME

ADDRESS

CITY..... ZONE..... STATE.....

Amplifiers Sound Different?

(Continued from page 41)

blown and the air coming out constitutes a d.c. component. When a stringed instrument, especially a string bass, is plucked, or a percussion instrument is played, these, too, produce a momentary deflection of the waveform one way or the other from the zero line at the start of the tone.

Thus it can be seen that any of these kinds of program material can initiate the low-frequency ringing we have described.

So What Happens?

In the old-fashioned kind of amplifier, without feedback, this kind of program material will produce a momentary change of bias on each stage through the amplifier. The time taken for each bias to change will depend on the time constant, as it is called, produced by the coupling capacitor and the associated circuit resistors. In other words, a continued trumpet tone will cause the bias on each stage to re-adjust itself by some fraction and each stage will take a moment or two to settle down to its new bias value. This is illustrated in Fig. 4. The time taken for each stage to settle down will be dependent upon the time required for the coupling capacitor to change its charge: larger capacitors will take longer and smaller ones will allow the change to take place more quickly.

In a non-feedback amplifier all these changes will take effect at so slow a rate that they will not contribute any audible difference to the sound of the output. But when feedback is applied to the amplifier, all these time constants interact so as to make the amplifier *almost* into a low-frequency oscillator. It does not quite oscillate, otherwise the amplifier would be audibly unstable, but any of these transients coming along will set it into a momentary state of oscillation, which takes a few seconds to die away.

The oscillation itself is not audible, because it is only at 1 or 2 cycles and the output transformer prevents any appreciable voltage at this frequency appearing across the loudspeaker voice coil, also the loudspeaker does not produce appreciable response at this very low frequency. However, the low-frequency fluctuation occurs at measurable amplitude at some point *inside* the amplifier circuit itself.

The asymmetrical kick given by the program waveform can set up an oscillation twice as big as the effective d.c. component. This means that quite a large fluctuation can occur inside the amplifier which will not be audible outside of it.

Effect on Program

So why does it cause trouble? Because the gain of every stage in the amplifier varies with operating bias. This low-frequency fluctuation is like

a periodic changing of the bias of several stages through the amplifier. Consequently the program material gets modulated at this low frequency. What we hear, then, is due to an intermodulation of the program material by this low-frequency oscillation.

If the feedback were not present (which, of course, is an impossible state to imagine, because the feedback is what is causing the oscillation), the effect most noticeable would be that the whole program would sound as if an electronic tremolo had been added. However, the presence of a large amount of feedback stabilizes the gain of the amplifier so the tremolo effect is not noticeable.

Instead, the same intermodulation that would cause a tremolo effect, but for the feedback, produces a much larger amount of IM distortion in the amplifier than occurs under static measurement conditions. This results in the harshness often observed in modern feedback amplifiers.

How All This Was Proved

These observations are not just the result of theorizing. To substantiate this, two amplifiers of conventional design were taken and modifications made to bring their designs into line with the established mathematical theory, giving the required stability margins at both ends of the frequency response to avoid peaking under any circumstances.

These changes resulted in a slight deterioration of the frequency response, but in neither instance did the response drop below 1 db at 30 cycles or 15 kc., which is still considered to be high fidelity. It is doubtful—extremely doubtful—whether a difference of 1 db at either 30 cycles or 15 kc. could possibly be heard "for itself alone." A-B checks were then conducted between the amplifiers, using their original circuits and the revised feedback circuits.

A difference was quite noticeable in the reproduction of program material, particularly with the kinds of program material in which, as has been discussed, there is asymmetrical waveform—when wind instruments are playing, or string instruments are played by plucking. These experiments certainly seem to have uncovered at least some of the major differences that can exist between amplifiers with equally good specifications—differences that do not show up, at any rate, in the standard method of specification. These are, in fact, defects that are not in the book! -50-

Fig. 4. (A) Asymmetric wave without isolating d.c. (B) Offsetting bias adjustment.

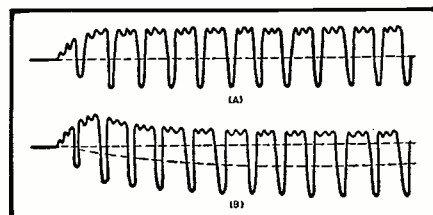

RADIO & TELEVISION NEWS

MARCH 1957

IN THIS ISSUE

- REAL LAMPS TUBE
- POP MUSIC
- STUDIO TECHNIQUES
- RECORDING EQUIPMENT
- AMPLIFIER COMPONENTS
- HOW TO USE ELECTRONIC EQUIPMENT
- REPRODUCING RECORDS
- RECORDING TECHNIQUES
- RECORDING EQUIPMENT
- RECORDING TECHNIQUES



COVER STORY

Singer employs hi-fi components to record and reproduce her voice.

HELEN MERRILL, a young singing star, recently paid a most interesting visit to the Masque Sound & Recording Corporation studios for some "sound" advice.

After listening to her sing, the sound technician had her experiment with a wide variety of recording components in order to help determine just which combination would most please the highly critical ears of both Miss Merrill and the sound technician.

Following each of the experimental run-throughs on "Irish" brand recording tape (manufactured by ORRadio Corporation), and using a Type D33A "Full-Vision" American Microphone Company unit, the recordist listened to a playback on the professional Presto tape equipment apparatus, which Masque uses exclusively for both recording and playback purposes.

In order to safeguard against the possibility of accidental erasure, these tape machines are furnished with playback equipment only. Two tape machines are run simultaneously, with identical tapes on each of these machines. However, the first recorder will have its volume turned up, while the second recorder runs without volume. If anything should happen to machine number one, its place is taken by machine number two. This is accomplished without a missed beat or sound.

Miss Merrill, who records for the EmArcy label (jazz subsidiary of the Mercury Records Corporation), requires hi-fi in her professional recording, performing, and also in her listening at home. Because of this, she is collecting components of professional quality for personal use so that she can make her own tape recordings. This will enable her to perfect her techniques for recording sessions, concerts, and night club appearances. —30—

The magic word in speakers!
ELECTROSTATIC
...product of 9 years
of JansZen
research

and backed by an unprecedented

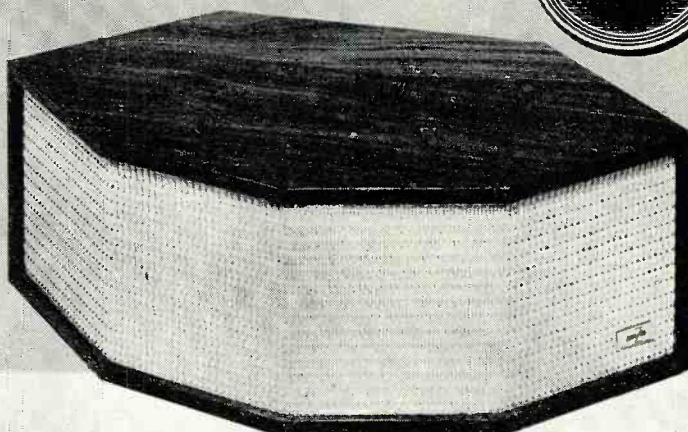

The JansZen Electrostatic speaker brings laboratory-perfect sound into your living room! Unlike paper-cone speakers, the Electrostatic transforms electrical energy directly into sound, through four electrostatic radiators arranged to give 500-30,000 cps. response at 120 degree dispersion.

Each of these four radiators is actually a condenser-type unit with a virtually massless diaphragm stretched between the plates... driven over its entire surface by variations in the electrostatic field. This diaphragm is so light, it acts like just a layer of air... thereby giving a perfectly flat response, free from breakup and resonances in the audible range. An additional advantage of the JansZen Electrostatic is that its radiators remain unaffected by changes in humidity and temperature... so stable and dependable are these radiators that we guarantee them for two full years!

**Radiators guaranteed 2 years;
 Balance of speaker guaranteed 1
 year. Based on a remarkable new
 principle in the transmission
 of sound.*

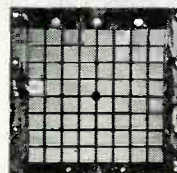

Mahogany,
 Birch, Walnut
 and Utility
 finishes available
 on request.

JansZen ELECTROSTATIC
Loudspeaker



Send for complete literature on the JansZen 1-30 Electrostatic
 as well as the name of your nearest dealer!

Product of NESHAMINY ELECTRONIC CORP. Neshaminy, Pa.
 Export Division: 25 Warren St., New York 7, N. Y. Cable: Simonrice, N. Y.

INTRODUCING

**AN ALL NEW
ELECTROSTATIC
TWEETER
(MODEL 5-20)**



REMARKABLE VALUE

AT ONLY \$29.⁵⁰

Combine this all New Electrostatic Tweeter with your present speaker system and realize the full capabilities of your Hi Fidelity System.

FEATURES

- Plug in combination with your present speaker system
- Built in crossover network and matching transformer
- Smooth response from 5000 to beyond 20,000 cycles
- Excellent transient response
- Uniform distribution of sound
- 360 horizontal omni-directional sound.
- Dimensions: 4½" x 4½" x 12"
- Hand rubbed cabinet in mahogany or blonde
- Radiating assembly guaranteed for 2 yrs.

Manufactured in the U.S.A.
Available at all leading Hi-Fi dealers. If your dealer can not supply, write
DEPT. R.

Pampa

ELECTRONICS CORP.
7334 FRANKFORD AVE
PHILA. 36, PA.

DEALER'S INQUIRIES
INVITED. WRITE DEPT. R.

The "Tiny Mite"
(Continued from page 52)

does not vent through the back. This construction makes it versatile in placement and essentially independent of the actual acoustical conditions of the walls and their construction as far as room loading effects are concerned. A representative machine-run curve of performance of the "Tiny Mite" enclosure for low frequencies when utilizing a 12" speaker, such as the *University* 6201, for the two conditions of corner placement and flat wall placement is shown. Note that although there is a three to four db difference in the low-frequency response of the system from 80 cps down, there is quite good performance quality for the flat wall placement because the enclosure is an integrally complete structure in itself without specific dependence upon room placement.

The tilted front panel serves two purposes. It reduces internal reflections between the back of the cabinet and the back of the speaker, thereby minimizing erratic frequency response in the mid-frequency area. The correlation between the 45 degree corners of the cabinet and the tilted relationship between the front panel and the back panel of the cabinet go far towards reducing internal standing waves of high pressure amplitude which can create mid-frequency disturbances. This is especially desirable where high-efficiency speakers are used, because extremely high internal pressures are created within the enclosure and unless means are taken to prevent such internal reflections, then there will be irregularities in the mid-frequency response of the speaker.

Construction Specifications

It is naturally very desirable to insure that the cabinet itself should not be vibrated by the high sound pressures built up within it. Accordingly, every effort should be made to insure that the individual panels are of good stock and secured so that they will not vibrate. Even though this enclosure is diminutive in size, it is, however, built from ¾" wood in order to fully withstand the high acoustic pressures built up within it (especially when used with high-efficiency speakers) and to consequently reproduce the total sound from the loudspeaker without itself absorbing any through panel vibrations. It is highly recommended that all the sections should be thoroughly glued together by means of the indicated glue blocks, that these joints be thoroughly sealed with glue during the assembly to prevent vibration of one edge of the panel against the other, and that re-enforcement by screws between panels and glue blocks be applied immediately upon glue application. This will squeeze the glue over the whole of the glueing surface and hold the parts in contact while the glue is setting without the use of cabinetmaker's clamps.

NEW

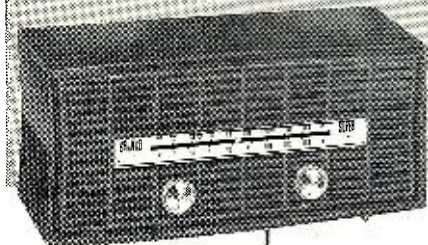

GRANCO

**HIGH FIDELITY
FM-AM TUNER**

JUST PLUG IT IN...

**to phonograph,
hi-fi system,
tape recorder**

**or TV set
for the best in
FM-AM**

radio listening!

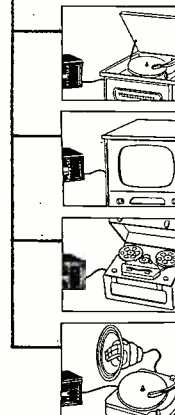

A new adventure in sound from leading sound specialists... a most versatile FM-AM tuner of fine quality, designed to provide the best static-free FM as well as AM radio reception by simply "plugging it in"... yet, in the Granco tradition of producing much more for much less, **priced lower than any other available tuner.**

More than just a component, this elegantly styled tuner easily connects to any instrument with an amplifier and speaker and affords complete radio listening pleasure... FM and AM.

- Exceptional sensitivity and selectivity insure superlative FM and AM reception
- 6 tubes plus selenium rectifier
- Famous Granco coaxial tuner for smooth, sharp, no-interference, drift-free tuning
- Straight A. C. chassis
- A complete package — built-in antennas eliminate installation
- Compact decorator cabinet fits handsomely into any decor

T-270 FM-AM TUNER only \$54⁹⁵*

—TECHNICAL FEATURES—

2.5 volts maximum audio output — tuning knob and OFF-AM-FM phono switch knob
FM Section: 5 microvolts sensitivity for 20 db. quieting — 88-108 mc. frequency range — 20-15,000 cycles flat audio frequency response — 220 kcs. at 3 db. down selectivity — 1.0% total harmonic distortion for 2.5 volts RMS output — built-in antenna. **AM Section:** 20 microvolts sensitivity per meter (on loop stick) — 535-1650 kc. frequency range — 8 kc. selectivity at 2 times down — 2.5% total harmonic distortion at 1 volt RMS output — built-in antenna.

FM means GRANCO



Write for complete specifications and FREE BOOKLET "Granco NEW SOUND Radio with FM".

*Price slightly higher South and West

GRANCO
PRODUCTS, INC.

16-27 20TH AVE. • LONG ISLAND CITY 5, N. Y.

— the leader in FM and UHF

As much as possible of the interior of the enclosure should be lined with Fiberglas, Kimsul, Ozite, or other sound absorbing material.

Speaker Installation

Where the "Tiny Mite" is to be used with a 12" speaker, such as the *University* Model 6201 coaxial or the Model 312 three-way "Diffaxial," then the speaker is mounted directly onto the main baffle board as shown in the "exploded" view. If, however, the installation is to start with a more modest speaker such as the 8" "Diffusicone," then the adapter plate should be secured to the main baffle board and the speaker secured to the opening provided for it in the adapter plate. It will be noted that the position of the mounting hole for the 8" speaker is such as to permit the mounting, if required or desired, of a tweeter directly above it. There is ample space in this area to provide a cutout for the *University* Model HF206 or Model 4401 type tweeters, as indicated in the constructional details.

It will be recognized that this latter application conforms to the *University* Progressive Speaker Expansion principle whereby one may start a hi-fi system with a quality loudspeaker, although modest in size, and then build up to a more versatile system at some future date. A tweeter, such as the *University* HF206 or Model 4401, may be mounted at the cutout on the adapter board. A network should be used which will permit the control of the level of the tweeter to balance that of the "Diffusicone 8," which now performs more as a woofer and mid-range unit. When a network such as the model N1 high-pass filter is used, it may be mounted on the side of the cabinet so that there will be easy access to the control for adjusting the level of the tweeter and the woofer for best balance between themselves and to room or program conditions. If the integral coaxial or three-way "Diffaxial" type speakers are used, then the volume control for the tweeters in these structures may also be mounted on the side of the cabinet.

Because of the compact size of the "Tiny Mite," it is especially suitable for use in stereophonic systems where it is not possible to use, or where it may not be economical to invest in, large and elaborate systems. With two such enclosures placed in adjacent corners in a listening room having average size, excellent low-frequency reproduction will be obtained with controlled dispersion of the highs feeding all parts of the room, yet providing the requisite localization of the two channels because of the separation of the two speakers. The corner response for this enclosure, shown in the curves, is indicative of the performance that may be expected from such a system when played in a corner by itself, where the properties of the room are conducive to good acoustic reproduction. In general, this enclosure meets the demand for a small, high-quality unit.

-50-

the cartridge that scores **100%**

The Recoton-Goldring cartridge was acclaimed the best by a national independent research organization, because it passed all tests with flying colors!



- Performance uniformly excellent.
- Cantilever - stylus - armature construction capable of rougher treatment than most moving-coil mechanisms.
- Will fit just about any American-made arm.
- Smooth and free of strain even on heavily recorded passages.

Recoton-Goldring

New

**MODEL "555 SDM"
MU-METAL SHIELDED
MAGNETIC TURNOVER CARTRIDGE**

At leading hi-fi distributors,
write for descriptive literature to:

RECOTON CORPORATION, 52-35 Barnett Ave., Long Island City 4, N. Y.

Manufacturers of World-Famous Phonograph Stylis.

In Canada: Quality Records Ltd., Toronto

DO YOU WANT A BETTER AMPLIFIER?

Build a 50 watt DYNAKIT

MARK II



\$69⁷⁵
net

A premium kit for the audio perfectionist, the Dynakit sounds better because it is designed for outstanding transient response and stability, for higher power at low distortion, and for complete and accurate reproducibility. The improvement over conventional circuits is immediately apparent to the discriminating listener.

The Dynakit combines unequalled quality with economy and simplicity. It features the finest of parts, like the superb Dynaco A-430 output transformer. At the same time construction is greatly simplified by the Dynaco pre-assembled printed circuit unit which includes the major portion of the wiring.

The Dynakit is sold complete with all parts and the pre-wired printed circuit assembly. Complete specifications are available on request.

USE A DYNACO TRANSFORMER TO MODERNIZE YOUR PRESENT AMPLIFIER

Dynaco super-fidelity transformers are a new design which permits lower distortion and wider frequency response in high fidelity amplifiers. Models are available from 10 to 100 watts including the 50 watt A-430 transformer which can be used to increase the power of Williamson Amplifiers to 50 watts.

MODELS

A-410 10 watts 6V6, EL-84	\$14.95
A-420 25 watts KT-66, 5881, EL-34	19.95
A-430 50 watts 6550, EL-34 (6CA7)	29.95
A-440 100 watts 6550	39.95
A-450 100 watts PP par 6550, EL-34	39.95

(all with tapped primaries except A-440 which has tertiary for screen or cathode feedback)

Full data and details of Williamson Amplifier conversion available on request.

AVAILABLE FROM ELECTRONIC PARTS AND AUDIO DISTRIBUTORS

DYNA COMPANY, Dept. RT, 5142 Master St., Philadelphia 31, Pa.

NOW! HI-FI **FM** IN YOUR CAR!

Only **BLUE SPOT** offers all these features!

Concert Hall Sound under bridges, through short tunnels, next to high power lines, even in lightning storms!

Constructed to outlast your car.

Coaxial Speakers, 6" x 9", full-range tone control, built-in rear speaker plugs, separate amplifier, 6 to 12 volt convertibility.

Compact design fits most American and foreign cars. Service throughout the U. S.



BLUE SPOT Köln Mark I

Selectomagic Tuner—the first FM "one touch" signal seeker in a car radio.

FM—3 microvolts for 20 DB quieting; **AM**, 3 microvolts. Response 40-16,000 c. p. s.—image rejection 25 DB.

HI-FI—15 tuned circuits FM and AM.

BLUE SPOT Frankfurt Mark I

FM—plus Hi-Fi, AM and Pushbutton Selectometer. De Luxe, yet economy-priced version of the Köln Mark I.

BLUE SPOT Hamburg

Luxury AM car radio—economically priced. Magnificent sound, pushbutton station selector, ruggedly engineered.

AMERICAN ELITE, INC.

7 Park Avenue, New York 16, N. Y.

Importers of **Telefunken** and **Audio Elite** home Hi-Fi Sound Systems, Tubes, Components, Microphones... and **Blue Spot** car radios.

Write Dept C for free pamphlet and information.

**RADIO
& TV NEWS**

**Watch
for Our
New Title
Next Month**

Effective with the April Issue, our logo will be simplified—Don't miss it at your regular newsstand!

WANTED



**Willing to pay cash for Early
Phonographs with outside horns**

WANT Coronet (illustrated), Double Bell Wonder, Victor Types A, D, and O, Monarch Special, and Improved Monarch. Also Edison Idellia, Excelsior, and Treadle Phonographs. Want early Bell-Tainter, American Gramophones, Multiphone, Multinola, Scott Magazine Phonograph, Peerless, Sovereign, Wizard Phonograph, Regina Hexaphone, and Graphophones. Also catalogues or old literature on phonos made prior to 1906. Want unusual machines and coin-in-slot cylinder phonographs.

A few duplicate Edisons and graphophones are now available for sale or trade.

Send clear snapshot and full information to
Box 50

RADIO & TELEVISION NEWS
366 Madison Ave., New York 17, N. Y.

Turntable Speed Problems

(Continued from page 47)

evenly as you can to the entire surface. Use a heavy-duty iron with a smooth, clean tip. If the solder refuses to adhere, try using the oxide that forms on the terminals of wet-cell auto batteries as a soldering flux. This works on almost every kind of steel.

The shaft or sleeve should now be oversized. Run the motor and turn down the shaft with a file in the manner previously described. If you accidentally go too far and take too much off, add more solder and begin again.

When finished, you will see that very little solder remains. This is because the average off-size shaft or sleeve is off but a few hundredths of an inch, or even less.

The Stroboscope

A stroboscope is a special low-persistence light source used for, among other things, checking turntable speeds. It is used in conjunction with a strobe card: a round disc with several circular rows of dots or lines, one row of which appears stationary under the light if speed is correct. These cards usually can be obtained free at electronic parts distributors.

An incandescent light bulb or a fluorescent lamp can be used with these cards, but use of a strong neon bulb held directly over the revolving card provides a brighter, more concentrated light that will flash rather than persist.

The following hook-up makes a handy and rugged neon strobe unit. Pick up a NE-42 neon bulb with socket and a 200-ohm resistance line cord from your electronic parts distributor. The resistance line cord drops the voltage down to the operating voltage of the neon bulb. Wire the cord to the socket and insulate any exposed metal on the socket with plastic electrical tape. The completed unit is shown in the photo of Fig. 4.

Operation is as follows: Place the strobe card on the turntable and turn on the motor. Select the turntable speed to be checked and note which row of dots on the strobe card is intended to appear stationary at that speed. Hold the strobe unit over the card as shown in Fig. 4. If the speed is proper, the corresponding circle of dots will appear motionless. If, instead, they crawl backwards, against the direction of the revolving turntable, the speed is slow. If they appear to crawl forward with the revolution of the table, the speed is too fast. If they fluctuate, yet do not gain or lose much on their position, you may have a case of wow caused by a flat on the large rubber drive wheel.

It is best, when checking speeds, to weigh down the turntable with two or three records to show up possible slippage. With patience and a little experience turntable speed correction can be fast, easy, and profitable.

—30—

GET IN ON THE TV

BOOM!



L. C. Lane, B.S., M.A.
President, Radio-Television Training Association. Executive Director, Pierce School of Radio & Television.

TRAIN FOR A TOP-PAY JOB AS A TELEVISION TECHNICIAN

NO PREVIOUS EXPERIENCE NEEDED — study AT HOME in your SPARE TIME

Next to the atom and hydrogen bombs, the biggest noise being made today is by the booming radio-television-electronics industry.

Now, while the boom is on in full force, is the time for you to think about how you can share in the high pay and good job security that this ever-expanding field offers to trained technicians.

Just figure it out for yourself. There are more than 490 television broadcasting stations operating right now

and hundreds more to be built; more than 40 million sets in the country and sales increasing daily. Soon moderately priced color television sets will be on the market and the color stampede will be on.

All these facts mean that good jobs will be looking for good men. You can be one of those men if you take advantage of my training now — the same training that has already prepared hundreds of men for successful careers in the radio-television-electronics field.



YOU GET ALL THESE IN THE BASIC COURSE

AF-RF Signal Generator

Super-Het Radio Receiver

C-W Telephone Transmitter
Public Address System

Combination Voltmeter-Ammeter-Ohmmeter

No experience necessary! You learn by practicing with professional equipment I send you. Many of my graduates who now hold down good paying technician jobs started with only grammar school training.

If you have previous Armed Forces or civilian radio experience you can finish your training several months earlier by taking my FM-TV Technician Course. Train at home with kits of parts, plus equipment to build YOUR OWN TV RECEIVER. ALL FURNISHED AT NO EXTRA COST!

After you finish your home study training in the Radio-FM-TV Technician Course or the FM-TV Technician Course you get two weeks, 50 hours, of intensive Laboratory work on modern electronic equipment at our associate school in New York City, Pierce School of Radio & Television. NO EXTRA COST.

With our TV Studio Technician Course (Advanced training for men with previous radio or TV training or experience) I train you at home for an exciting top-pay job as the man behind the TV camera. Work in the TV studios or "on location" at remote pick-ups! Optional N.Y.C. additional training.

RADIO-FM-TV TECHNICIAN TRAINING

FM-TV TECHNICIAN TRAINING

EXTRA LABORATORY TRAINING IN NEW YORK CITY AT NO EXTRA COST!

TV STUDIO TECHNICIAN TRAINING

LEARN BY DOING—As part of your training I give you the equipment you need to set up your own home service shop and prepare for a BETTER-PAY JOB. You build and keep a Television Receiver designed to take any size-picture tube up to 21-inch, (10-inch tube furnished. Slight extra cost for larger sizes.) . . . also a Super-Het Radio Receiver, AF-RF Signal Generator, Combination Voltmeter-Ammeter-Ohmmeter, C-W Telephone Transmitter, Public Address System, AC-DC Power Supply. Everything supplied, including all tubes.

EARN WHILE YOU LEARN—Almost from the very start you can earn extra money while learning by repairing radio-TV sets for friends and neighbors. Many of my students earn enough from spare time earnings to pay for their entire training . . . start their own profitable service business.

FCC COACHING COURSE—Qualifies you for Higher Pay! Given to all my students AT NO EXTRA COST. Helps you qualify for the TOP JOBS in Radio-TV that demand an FCC license! Full training and preparation at home for your FCC license.

VETERANS!

My School fully approved to train Veterans under new Korean G.I. Bill. Don't lose your school benefits by waiting too long. Write discharge date on Postage-Free card below.

CUT OUT AND MAIL TODAY! POSTAGE FREE!

SEE OTHER SIDE

Yours FREE

NO STAMP NEEDED!
WE PAY POSTAGE!

Dear Mr. Lane: Send me your NEW FREE BOOK and FREE SAMPLE LESSON that will show me how I can make TOP MONEY in TELEVISION. I understand I am under no obligation.

(PLEASE PRINT PLAINLY)

Name _____ Age _____

Address _____

City _____ Zone _____ State _____

I AM INTERESTED IN:

- Radio-FM-TV Technician Course
- FM-TV Technician Course
- TV Studio Technician Course
- Color-TV Course

VETERANS!
Write discharge date

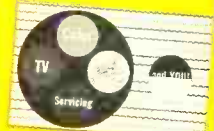
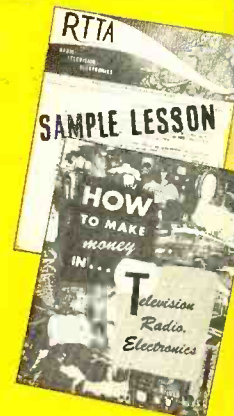

Radio-Television Training Association

52 EAST 19th STREET • NEW YORK 3, N. Y.

licensed by the State of New York • Approved for Veteran Training

There's a "POT of GOLD" waiting for YOU — at the end of this COLOR-TV servicing rainbow!

Introducing RTTA's COLOR-TV TECHNICIAN COURSE

(advanced training for men who have had radio and TV experience)



Color television receivers will demand installation, set-up, adjustment and servicing by highly trained specialists—training and skill which you can acquire in your spare time, at home through RTTA's up-to-the-minute COLOR TELEVISION TECHNICIAN COURSE. All of the latest information and methods for the servicing and maintenance of all color TV receivers and equipment. Trains you thoroughly, accurately and reliably. You will be on a par with the best, anywhere! **To qualify for this specialized training it is necessary to have had previous radio, television training or experience.**

The step-by-step approach found so successful in teaching our Radio-FM-TV Course, FM-TV Technician Course and TV Studio Technician Course is used in this new, up-to-the-minute COLOR TELEVISION TECHNICIAN COURSE. With the RTTA way, you set your own pace for learning—as rapidly or as moderately as suits your own personal convenience. Lessons are written in easy-to-understand language that everyone can follow. They

are illustrated throughout enabling you to grasp the full meaning of concepts immediately.

The course begins with an introduction to the Laws of Color and defines the differences between the transmission and reception of black-and-white and of color television. Starting at the transmitter you are guided through the development of, and transmission of, the composite Color TV signal. With an over-all view of how the receiver functions each circuit is then analyzed. A knowledge of how Color TV circuits work, both as individual and as cooperative units in the receiver, prepares you for all future developments in the field of Color TV. You also receive thorough instruction on test instruments, alignment, as well as servicing. The RTTA Color TV Course features all of the latest information.

For a complete description of the course, send today for your FREE copy of the RTTA COLOR TV Course Brochure.

SYLVANIA SELECTS RTTA's COLOR TELEVISION COURSE FOR ITS EDUCATIONAL PROGRAM

Service dealers throughout the U.S. will soon be able to learn Color Television from the best available information.

The selection of RTTA's COLOR TELEVISION COURSE by Sylvania Tube Division, one of the nation's top manufacturers of receiving tubes and picture tubes is an added assurance to you of the tremendous value of this course. We are proud of this endorsement by Sylvania. It indicates the outstanding merit of the RTTA course. We know that a company such as Sylvania which has earned its fine reputation over the

years through the high standard of its products and through leadership, would extend such recognition only after careful cooperation and examination by its staff of experts and engineers. They concluded that the RTTA course offers the best opportunity of studying Color Television on a practical basis—to learn the subject thoroughly.

The Color Television Technician Course is being made available to authorized Sylvania Dealers throughout the 48 states who are interested in expanding their knowledge and experience in Color TV servicing.

SEE OTHER SIDE

CUT OUT AND MAIL TODAY! POSTAGE FREE!

FIRST CLASS
Permit No. 62058
(Sec. 34.9, P. L. & R.)
New York, N. Y.

BUSINESS REPLY CARD

No Postage Stamp Necessary if Mailed in the United States

POSTAGE WILL BE PAID BY

RADIO-TELEVISION TRAINING ASSOCIATION

52 EAST 19th STREET, Dept. AB-3

NEW YORK 3, N.Y.

14 THOROUGH LESSONS

- 1 AN INTRODUCTION TO COLOR
- 2 FORMATION OF THE COLOR SIGNALS
- 3 THE CHROMA SIGNALS
- 4 GENERAL OPERATION OF THE COLOR TELEVISION RECEIVER
- 5 PICTURE TUBES FOR COLOR TELEVISION RECEIVERS — PART I
- 6 PICTURE TUBES FOR COLOR TELEVISION RECEIVERS — PART II
- 7 DETAILED OPERATION OF THE COLOR TELEVISION RECEIVER
- 8 THE CHROMINANCE CHANNEL
- 9 COLOR TELEVISION CIRCUITS — PART I
- 10 COLOR TELEVISION CIRCUITS — PART II
- 11 ADJUSTING THE COLOR TV RECEIVER
- 12 COLOR TV TEST EQUIPMENT
- 13 TROUBLESHOOTING THE COLOR TV RECEIVER
- 14 SERVICING PROCEDURE

SEND FOR YOUR ENROLLMENT APPLICATION TODAY!

FM Tuning Indicators

(Continued from page 61)

provide enough pointer action for satisfactory tuning.

On the other hand, 100,000 ohms total resistance will load down the audio output circuit somewhat, as well as increase distortion slightly. The loading effects vary from tuner to tuner. In one tuner tried, the addition of a 100-0-100 microammeter in series with the 100,000 ohms resistance caused an output loss of about 3 db, while in a second the loss was 6 db. With respect to distortion, in both cases IM distortion went up something less than about 0.5%. In the case of the first tuner, which had optional a.f.c., output was reduced only 1 db in the a.f.c. position, while IM distortion increased only about 0.2%.

To avoid the possibility of loading effects, it is advisable that the meter series resistor be about 500,000 ohms (in conjunction with *R* in Figs. 4, 6, 7, 9). Assuming 5 volts d.c. at the audio output when off-tune, this would result in about 10 microamps of current for driving a center-of-channel meter. Meters of this sensitivity, that is, a 10-0-10 microampere movement, are available but costly, ranging from \$20 to \$30. A 25-0-25 microampere movement is somewhat less expensive and would still be effective. Such meters are seldom stocked by radio supply houses, but can be ordered directly from the manufacturer. Inasmuch as these are special order items, delivery may require from a few weeks to two or three months.

Some of the FM tuners on the market today use the compact and attractive side indicator. As far as the author knows such instruments are not available through regular jobber channels; however, the one shown in the photograph is available from *International Instruments Incorporated*, P. O. Box 2954, New Haven 15, Conn. The one illustrated is this firm's Model ASP-488, a 100-0-100 microampere unit, which sells for \$21.00. Side indicators of this type are used in the *Pilot AF-860 AM-FM tuner*.

Lovers of quality sound reproduction will find it well worth the time and money involved in adding a tuning indicator of some type to their FM tuners to insure on-the-nose reproduction of their favorite selections. —30—

Fig. 10. Use of zero-center d.c. milliammeter as a center-of-channel indicator.

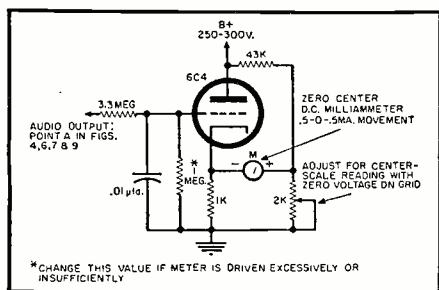

March, 1957

ARKAY Kits . . . lead the field

new!

ANOTHER ARKAY FIRST!!

SPECIFICATIONS:
ELECTRICAL RATING—9-volt transistor energizer.
OPERATING FREQUENCIES: TUNING RANGE—540 to 1620 KC. I.F. AMPLIFIER—455 KC.
POWER OUTPUT—275 + milliwatts.
SPEAKER—large alnico V permanent magnet.
TRANSISTOR COMPLEMENT: X1 oscillator-converter; X2 1st I.F. amplifier; X3 2nd I.F. amplifier; D1 diode detector-AGC take-off; X4 class B driver; X5 class B output; X6 class B output.



\$3750

Federal Excise Tax Included

introducing

TRANSISTORIZED PORTABLE SUPERHET RECEIVER

The Model TR-6 is a newly designed all transistor portable superheterodyne receiver with push-pull Class B output providing clear crisp output better than 275 milliwatts. Construction of the TR-6 is extremely simple because of the advanced engineering techniques employed in its design.



ARKAY Model 2X4 2 Band Portable

Top performing 2 band AM-Shortwave. Dial shows countries transmitting. Kit utilizes 4 low drain-hi gain miniature tubes plus selenium rectifier for electric power. Tuning range 550-1600kc. 6-18mc. Size: 10 1/2 x 7 x 5 1/4 attractive leatherette cover. Complete with tubes, nuts, etc. except wire & solder & batteries. Easy-to-follow instructions. Uses 1 each Burgess 8X45, C5. For 110-120 volt 50-60 cycle AC-DC or batteries... **\$26.75**
Batteries for above... \$3.16
Fed. Ex. Tax incl.

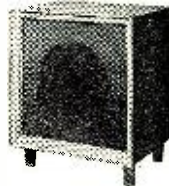

ARKAY Model B-12S Hi-Fi Speaker System

Easy-to-assemble infinite impedance baffle exceptionally clean response 40-13,000 cps. Kit when assembled measures 17x17 1/2 x 15 5/16" exclusive of Hollywood legs. Cut to size, nail and glue—complete with nails, glue, trim, insulation, grille cloth, legs, step-by-step instructions. Hi-Fi Coaxial Speaker & variable balance control... **\$29.95**



ARKAY Model FL-5 Hi-Fi AMP.

Full 5 watt amplification for true Hi-Fi performance in average rooms. Accepts tuner or phonograph of your choice and provides unusual tonal realism. Frequency response is 20-18,000 cps. at ±1.5 db. Uses 4 miniature tubes for low hum and noise level.

less cover

\$10.75

Cover \$1.50
Federal Excise Tax Included



ARKAY Model HFT-7 Hi-Fi AM-FM Tuner

4 UV sensitivity for 20 db quieting. Automatic frequency control with provisions for AFC erase. Allows pinpoint, high selectivity tuning. Foster-Seeley discriminator, high efficiency AM loop stick antenna and temperature compensated oscillator circuit. **New! Wired & Tested \$49.95**
Kit Less Cover... **\$32.00**
Cover for Above... \$ 3.95
FM Only... \$25.75
Fed. Ex. Tax Incl.



NEW!

ARKAY MODEL FL-30 Hi-Fi AMP-PRE-AMP

SPECIFICATIONS:
POWER—30 watts @ 1% IM.
FREQ. RESPONSE ±1/2 db.—10,40,000 cps.
HUM—120 db. below rated output.
CONTROLS—(6) Func. selector, loudness, bass, treble, level set, 5-position level compensation control.

Featuring a transistorized front end for use with a reluctance pick-up, this engineering masterpiece assures the finest in Hi-Fi reproduction. Record equalization for more than 30 labels (LP, RIAA, & EUR). Complete with rose gold panel and black cabinet. **KIT \$49.95**

WIRED & TESTED... \$74.95

FREE! Get the new, big catalogue & specifications of the remarkable ARKAY line—Now at your local dealer!
Prices 5% higher West of the Mississippi

ARKAY · 120 Cedar Street · N.Y.

50 WATTS from your WILLIAMSON

New DYNACO A-430



\$29.95

at your Electronic Parts Distributor or Audio Jobber

Output transformer and simple circuit modifications let you raise the power of your Williamson-type amplifier to over 50 watts at less than 1% I M distortion. This super-fidelity output transformer will give you double power and double listening pleasure with very low distortion and unequalled transient bandwidth. Its unique design uses para-coupled windings, the first basic advance in quality transformer design since the introduction of interleaved windings.

SEE OUR AD ON PAGE 97

Write for details of new Dynaco output transformers, circuits, and conversion data for Williamson Amplifiers.

DYNA COMPANY, Dept. A, 5142 Master St., Phila. 31, Pa.

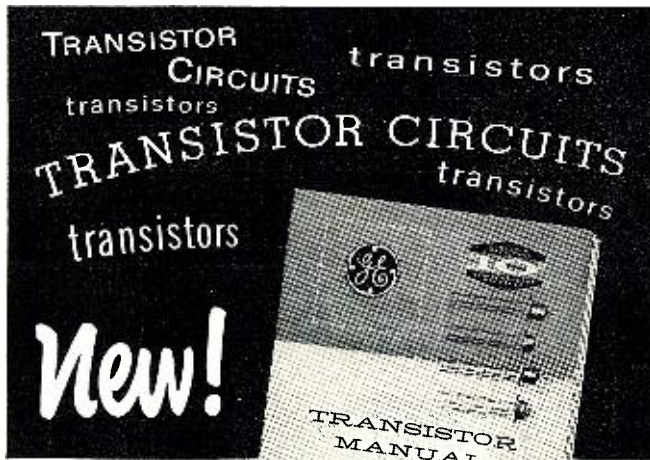

TRANSISTOR MANUAL HAS THE FULL STORY

What they are—How they work—Where they are used

Every ham, hobbyist, technician, and dealer needs this manual. The 60 fact-packed pages—illustrated with diagrams, sketches, and circuits—contain these seven important sections:

- **Principle of Semiconductors**...how electrons move through the transistor, and how the movement is directed.
- **How Transistors Are Constructed**...telling the methods for producing all types—and how they are biased.
- **Transistor Applications**...describes the circuit design, and transistor function of each design.
- **Specifications on G-E Transistors**...complete specs on all G-E types, with chart explaining parameter symbols.
- **Registered RETMA Transistor Types**...Tabulation of all transistors now recognized by RETMA, with information on each and cross-referenced to General Electric types.
- **Transistor Circuit Diagrams**...carefully selected circuits for typical transistor applications—from simple to complex.
- **Cross-Reference Chart for Transistorized Radios.**

Rush your order for this invaluable transistor book now. Only 50¢. Send coupon, or obtain at your General Electric Tube Distributor. Not available in bookstores. *General Electric Company, Semiconductor Products Department, Electronics Park, Syracuse, New York.*

GENERAL ELECTRIC COMPANY
Semiconductor Products Department, Section S5837
Electronics Park, Syracuse, New York

Send me the new Transistor Manual—50¢ remittance is enclosed.
(PLEASE PRINT)

NAME.....
ADDRESS.....
CITY..... STATE.....

Progress Is Our Most Important Product

GENERAL ELECTRIC

Certified Record Revue (Continued from page 48)

Philharmonic, but very comfortable to listen to and notably precise in most of its statements.

The other works on the record are welcome first LP recordings of two highly regarded English scores, the hauntingly lovely "A Shropshire Lad" of Butterworth, and the beautiful and exotic "Garden of Fand" by the "Master of the Queen's Musick," Sir Arnold Bax.

The sound in the Vaughn Williams and the other works is typical Mercury "Olympian," little different than prevails in this country, allowing for the newness and strangeness of the orchestra. Strings have the usual bright sheen and smoothness, coupled with plenty of bite. Woodwinds are very accurately registered and pure-toned, brass has plenty of weight and sparkle . . . percussion comes through with the expected authority, robust and sharply etched. Acoustics are more spacious than one is used to in the American recordings, yet there is the wealth of detail and orchestral definition we have come to expect in recordings of this company. Hi-fi fans will find the brilliant "Toccatà" movement in the Vaughn Williams score a riot of percussion running the gamut of dynamic expression. All in all, an auspicious debut for Sir John and the Halle Orchestra on the Mercury label and one looks forward with anticipation to recordings of works which are Barbirolli's particular metier.

STRAUSS, RICHARD DON QUIXOTE

NBC Symphony Orchestra conducted by Arturo Toscanini with Frank Miller, cellist and Carlton Cooley, violinist. Victor LM2026. RIAA curve. Price \$3.98.

Another Toscanini legacy from the Victor vaults, this time the 1953 broadcast performance of what many people consider Richard Strauss' greatest tone poem, "Don Quixote." The sixth LP of the score to appear, it probably won't displace the Clemens Krauss recording in the affection of confirmed Strausites, for it lacks the warm contours of that performance. However, many others, including yours truly, will like the brilliant exposition by Toscanini, where his probing insight reveals with crystal clarity the mastery of Strauss' orchestral writing. The soloists are uniformly excellent and the sound is by far the best of the "broadcast" performances thus far released. Definitely worth your while.

Since the great Maestro has left us, Victor will undoubtedly release many of his old recordings to his grieving public. Even before Toscanini's death, there was a small trickle of new recordings coming from the RCA Victor presses—including a number of collections compiled from his earlier disc recording sessions and tapes made at various public performances. Since part of the "off-the-air" recordings are vintage items, some of the quality is uneven, but they will be none-the-less welcome to Toscanini's public.

JOLIVET, ANDRE CONCERTO FOR PIANO AND ORCHESTRA CONCERTINO FOR TRUMPET, STRING ORCHESTRA, AND PIANO ANDANTE FOR STRINGS

L'Orchestre du Theatre des Champs-Elysees conducted by Ernest Bour. Ducretet-Thomson DT193014. RIAA curve. Price \$4.98.

This is a real sleeper! The composer is a relatively unknown French modernist, who is not loathe to employ plenty of dissonance and atonality in his scores but who also uses a leaven of lyricism as well, even sometimes to the spirit if not the point of romanticism. This makes for some extremely interesting works, several prime examples of which can be heard on this disc from London Records' French subsidiary. The "Andante" is an adequate filler, the "Concertino" rather strong medicine, but the piano concerto is a sizzler! A very exciting score that hurls itself forward with terrific impetus, it is notable for the almost constant use of percussion in conjunction with the piano. With the crisp clean sound, the best yet from this label, this is sure to please the hi-fi fan who has developed a taste for some of the more esoteric of modern works.

BRUCKNER SYMPHONY #4 ("ROMANTIC")

Pittsburgh Symphony Orchestra conducted by William Steinberg. Capitol P8352. RIAA curve. Price \$3.98.

This eighth LP of Bruckner's most popular symphony is somewhat of a surprise, since we have had little evidence of Steinberg's affinity for the works of this composer. His reading indicates a thorough knowledge of the score and he gives a sympathetic and leisurely-paced performance. He does not manage the surpassing warmth of the old Klemperer reading, but neither does he drag his feet as do some of his competitors. Purists may object to the fact that Steinberg here uses the more abbreviated Lowe edition of the score but

there is no denying the fact that this concise version is easier to assimilate and has the economic advantage of being complete on one LP instead of the two discs of the uncut version. Soundwise this is beyond most of its competitors. Everything has been kept clean-lined and smoothly articulate, a "must" in this score, which can become thick and turgid with the wrong engineering.

SAINT-SAENS

PIANO CONCERTOS #2 AND #4
Jeanne-Marie Darre, pianist with Orchestre National de la Radiodiffusion Francaise conducted by Louis Fourestier. Capitol P18036. RIAA curve. Price \$3.98.

The only LP to couple these concerti, this is another of Capitol's excellent new European series of recordings. Mme. Darre plays these highly listenable works with a great deal of verve and dash and in spite of some rather formidable competition, in both scores, comes closer to the spirit of them. Rather broad, heavy piano sound, recorded close-to with the piano at times a mite overbalancing the orchestra, but good and clean nonetheless.

SCHUMANN

**FANTASIESTUCKE
WALDENSZENEN**
Friedrich Gulda, pianist. London LL1371. RIAA curve. Price \$3.98.

Gulda, whose jazz exploits at New York's "Birdland" has earned him considerable notoriety, shows in these Schumann works that he hasn't been "tainted" as some people would have you believe. He is first and foremost a classical artist and his playing here is in the best traditions of the instrument. His flowing, polished phrasing and expressive dynamics in the "Fantasiestucke" and his sensitivity and restraint in the "Waldscenen," coupled with the light airy, clean-toned piano sound make this the most desirable of the available versions.

**HANDEL
SOLOMON**

John Cameron, baritone; Alexander Young, tenor; Elsie Morrison, soprano; and Lois Marshall, soprano; with The Beecham Choral Society. Royal Philharmonic Orchestra conducted by Sir Thomas Beecham. Angel 2546B. RIAA curve. Price \$9.96. Two discs.

To record Handel's "Solomon" has been long desired by Sir Thomas and thanks to his new alliance with Angel Records, it has come to pass. Sir Thomas has some very definite ideas regarding "Solomon," and purists looking for an uncut traditionally sung version will not find it here. He has greatly rearranged the work, both sequentially and in manner of performance. Soloists are returned to greater prominence than the choruses in keeping with the essentially non-ecclesiastical nature of the work. In fact, there is about this "Solomon" very much the flavor of an opera, rather than an oratorio. The entire score has also been re-orchestrated by Sir Thomas. The result of all this change is a more cohesive, highly dramatic "Solomon," which is a new and exciting listening experience. To hear this is to know the loving care Sir Thomas lavished on the score. He has chosen his forces with great care and then nurtured them and molded them into a sensitive, responsive instrument. His sense of balance is almost uncanny, and soloists, chorus, and orchestra are always completely distinct and articulate. The chorus is beautifully trained, the Royal Philharmonic plays magnificently under the urgings of its master, the soloists all exhibit a high degree of competence with the many florid Handelian difficulties.

Angel's engineers have done nobly by Sir

WORKING WITH RF?

These Blonder-Tongue accessories are designed as convenient — and often — indispensable aids to the man working with RF cable — in research, development and production.



SOLDERLESS COAX CABLE CONNECTORS and accessories

Cut time and effort making cable connections and splices. The secret is in the 'cinch-spring' — a B-T exclusive feature, that grips the conductor lead like a vise. Shield braid makes positive electrical contact, and outer covering is securely clamped and held for maximum mechanical support.

SOLDERLESS COAX CABLE CONNECTORS

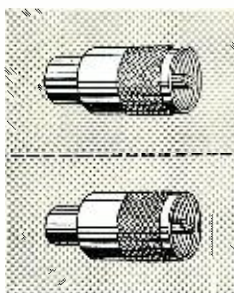

Model P-11S
Standard male fitting designed for use with the following types of coax cable: RG/U 8, 9, 9A, 10, 11, 12, 13, 63, 79, 87A, 114, 117, 133 and 144. \$1.75 list

Model P-59S
Standard male fitting designed for use with the following types of coax cables: RG/U 59, 62, 71 and 140. \$1.75 list

CABLE COUPLER Model MC

A correctly matched, mechanical splice for two similar or dissimilar types of 75-ohm coax cable fitted with P-11S or P-59S connectors. Also used for terminating cable with Terminating Plug MTP-75 or as feed-through in weatherproof housings. \$2.50 list

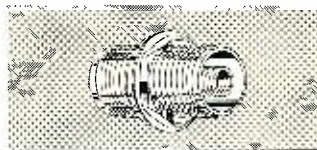

TERMINATING PLUG Model MTP-75

Provides correct termination of 75-ohm cable fitted with P-11S or P-59S connector and MC Cable Coupler. \$2.50 list

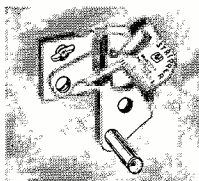
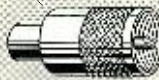

ROTARY CABLE STRIPPER Model S-1
A handy, accurate tool. Quickly and easily strips insulated and shielded wire and cable. Cuts braid clean. Also cuts non-metallic tubing up to 1/2" diameter. \$3.75 list

EXACT MATCH TV ACCESSORIES

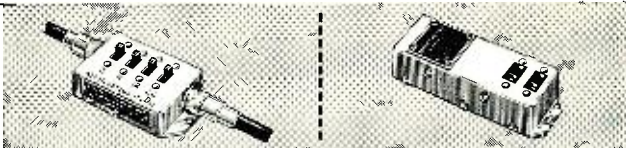

ATTENUATOR Model MAT
Provides uniform attenuation from 0 to 45 db, in 3 db steps, in frequency range 0-220 mc. Has 75 ohm 'in' and 'out' fittings. \$22.50 list

POWER LINE FILTER Model MLF
Provides 60 db RF isolation in frequency range 50-1000 mc, between input and output. Handles up to 5 amps. Has two AC outlets and one BX cable input connector. Can mount in B-T Radiation-proof Housing, Model MRH-A. \$49.40 list



Sold by Radio-TV Parts Distributors and Jobbers
Write for Complete Catalog to Dept. RN-3

BLONDER-TONGUE LABS. • 9-25 Alling Street • Newark, New Jersey

Industrial TV Cameras • TV Systems

VHF and UHF Amplifiers and Converters • TV Accessories



TREAT for RECORDS

Treat your records to the amazing ESL electrodynamic cartridge. By greatly prolonging the life of valuable records and styli, the ESL can save many times its own cost.

Treat your ears to the ESL—the pickup rated tops by the authoritative Audio League. Impartial Audio League tests show that the ESL is unsurpassed in smoothness, clarity, and naturalness of reproduction.*

Join the musicians, engineers, and music lovers who have switched to the world's most advanced cartridge. Write for details, and buy the ESL at your audio dealer's.

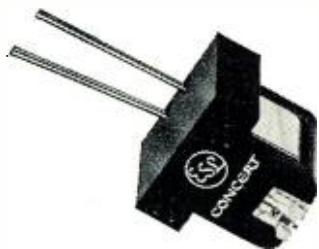

FOR LISTENING AT ITS BEST

Electro-Sonic Laboratories, Inc.

Dept. R • 35-54 Thirty-sixth Street • Long Island City 6, N.Y.

Soloist Series from \$14.95 • Concert Series \$35.95 • Professional Series arm and cartridge \$106.50

*Authorized quotation No. 63. Please consult The Audio League Report, Vol. 1, No. 6-7 (March-April 1955) for the complete technical report and listening evaluation of the ESL. Subscription: 12 issues, \$4. from P. O. Box 262, Mt. Vernon, N. Y.



"Golden Series" HI-FI



The "GOLDEN ENSEMBLE"... Tuner, Preamp and Amplifier in a single, compact, balanced unit...complete Hi-Fi at extremely low cost...

one of a complete line of advanced design high fidelity tuners, amplifiers and components...

hear these quality RAULAND units at your Hi-Fi dealer or write for details...

RAULAND-BORG CORPORATION

3515 W. Addison St., Dept. T, Chicago 18, Ill.

NEW—TRANSISTORIZED RADIO KIT



Model TK-104, a professionally engineered, completely transistorized superhet receiver kit.

- Printed Circuit Chassis 4 transistors
- Self Contained Speaker—18 mw. Output
- External Phone Jack
- High Gain Ferrite Loopstick Antenna
- Texon Leather Case
- Completely Sub-miniature
- Measures Only 6 x 4 x 2"
- Complete Easy To Follow Instructions

Model TK-201, a two transistor preamplifier kit on a printed circuit board. Complete with all parts and simple easy to follow instructions. The wide frequency range of this preamplifier will please even the most discriminate audiophile.

Order from your dealer or jobber or for more information write today to:

TRAN-KIT ELECTRONICS

467 SOUTH 5th AVE., DEPT. RT2 MT. VERNON, N. Y.

Thomas and have afforded the work superb over-all smoothness, coupled with great clarity and definition and warm and spacious acoustics. An outstanding musical experience about which Sir Thomas and *Angel* can be justly proud.

TCHAIKOVSKY SYMPHONY #5

Paris Conservatory Orchestra conducted by Georg Solti. London LL1506. RIAA curve. Price \$3.98.

The 21st (or is it the 22nd?) version of this weary warhorse. To those who would cry, why bother? . . . remember that every conductor has his own ideas about how the score should be handled, and there is that point of interest, if nothing else. Of course, from a purely sonic viewpoint one can look for new technical innovations which may have been employed in the recording.

Solti is a highly regarded conductor and his attitude in this reading is strictly "no nonsense" . . . his tempi are a bit on the fast side but with his general approach keep the work from cloying as it does in the hands of so many others. A taut, intense reading, it is a welcome change after so much sticky sentiment. Of course, things can be carried too far, and unfortunately Solti remains too inflexible during the 3rd movement and the "Valse" loses much of its poetry. The sound is surpassingly good . . . of the "big-hall" variety it generates plenty of excitement and will undoubtedly be a prime sales factor for this recording.

STRAUSS, RICHARD SALOME EXCERPTS ELEKTRA EXCERPTS LE BOURGEOIS GENTILHOMME SUITE

Inge Borkh, soprano; Francis Yeend, Paul Schoeffler with Chicago Symphony Orchestra conducted by Fritz Reiner. Victor LM6047. RIAA curve. Price \$7.96. Two discs.

This is a sensational recording but it is a crime and a pity that with the forces available, *Victor* chose to do only excerpts rather than the complete "Salome" and "Elektra." Inge Borkh is dazzling in her power, and the voice is beautiful. Her acting is on a very high plane, and her characterizations quite believable. Her "Salome" is excellent, except for some straining in the finale, and her "Elektra" is tremendous . . . the blazing intensity of her vocal projection in this role, absolutely top-drawer. Schoeffler is splendid as "Orest" in "Elektra" and Francis Yeend as "Chrysothemis" equally satisfactory. But quite possibly the major share of credit for the success of this album should go to Fritz Reiner and the Chicago Symphony. His conducting and their playing of these grisly scores is among the best I've ever heard.

The engineers have collaborated to produce one of the most awesome sounding records in the *Victor* catalogue. If you want to hear something absolutely hair-raising, listen to the finale of "Elektra"! Wow! The suite from "Le Bourgeois Gentilhomme," which used to be a Reiner specialty, was surprisingly slow-paced and rather disappointing.

BEETHOVEN SYMPHONIES #4 AND #8

Minneapolis Symphony Orchestra conducted by Antal Dorati. Mercury MG-50100. RIAA curve. Price \$3.98.

Mr. Dorati is not supposed to know how to conduct Beethoven according to some critics, a statement to which I certainly do not subscribe. Admittedly, his greater talent lies in the direction of other repertoire, but how foolish it is to categorize a conductor of his stature. That this is folly is borne out by this Beethoven disc. While Dorati's read-

ing of the "4th" falls short on several points, especially from the aspects of lyricism, his performance of the "8th" is the outstanding version now available. He imbues this work with a gaiety and zestful spirit quite to the point of the score. His unflagging rhythmic drive holds together the diverse elements of the first movement and emphasizes the bubbling exuberance of the final *allegro vivace*.

Mr. Dorati's light hand on the orchestral reins keeps the metronomic second movement properly humorous, and in the third movement *menuetto* affords it the flowing grace and classic style as Beethoven's "bow to the past" intended. If Dorati's reading of the "4th" symphony does not reach any pinnacles, it does however share with the "8th" symphony the distinction of being the best sounding editions now available. Strings are universally smooth and clean, woodwind and brass bright and pure in sonic contour. A complementary balance is maintained between all orchestral elements in a felicitous acoustic atmosphere.

ROZSA

CONCERTO FOR VIOLIN AND ORCHESTRA

Jascha Heifetz, violinist with Dallas Symphony Orchestra conducted by Walter Hendl.

SPOHR

CONCERTO #8 FOR VIOLIN AND ORCHESTRA

Jascha Heifetz, violinist with RCA Victor Orchestra conducted by Izler Solomon. Victor LM2027. RIAA curve. Price \$3.98.

Rozsa is a Hollywood composer who has won considerable recognition for his exotic scores for the pictures "Spellbound" and "A Double Life." It is the usual fashion among critics to lightly dispose of the efforts of the Hollywood practitioners, but it would take a really hidebound one to deny the strength and substance of this Rozsa concerto. Here in its disc premiere, it reveals itself as an ideal vehicle for the talents of Heifetz, and a highly listenable work. Cast in a firm melodic line, it has a first movement of brilliance and power, a soulful "Hungarian" 2nd movement, very rhapsodic and *cantabile*, and a gay and spritely *vivace* finale. Not at all the Hollywood stereotyped sort of thing, it is fairly difficult in construction and keeps the great Heifetz on his mettle. With splendid sound and excellent support from conductor Hendl and the Dallas Orchestra, this is a worthwhile addition to the recorded literature of the violin.

The Spohr work is at opposite ends of the pole musically from the Rozsa piece. The work was written in imitation of a three-part opera aria on the occasion of a visit to Italy. Not as easy to play as it sounds, it is a pleasant work that wears well on repeated listening. Heifetz displays a big singing tone here that falls on the ear most persuasively. A Tchaikovsky trifle, the "Serenade Melancholique," fills out this disc, which I recommend for the musical sophisticates among my readers.

ORFF, CARL DIE KLUGE

Philharmonia Opera Company and Orchestra conducted by Wolfgang Sawalisch. Angel 3551B/1. RIAA curve. Price \$9.96. Two discs.

Carl Orff and his strange music burst on the American scene like a bombshell, with his "Carmina Burana" and "Carmina Catulli," and there have been repercussions ever since. The New York City Opera Company just recently gave several performances of his controversial opera, "Der Mond." It is almost impossible to use conventional forms in which to fit his music. This work, for instance, is performed by an opera company, but it is not an opera in its truest meaning, March, 1957

\$100,000

Hi-Lo is covered by a \$100,000.00 insurance policy issued by one of the largest insurance companies.*

GUARANTEED PERFORMANCE

Each and every Hi-Lo is backed by a money back guarantee. For the best reception, unsurpassed clear pictures, specify Hi-Lo, with the exclusive highest gain, spiral designs which are covered by the following U.S. patent numbers: 2,495,579; 2,583,745; 2,724,773; 2,748,387; 2,755,466; and Canadian Patents 1951 and 1956; other patents pending.

**New...
Just what
you asked
for!**



Hi-Lo Model 505 — Channels 2-83
The spiral antenna that is designed for maximum performance featuring the NEW TELESCOPING DIPOLES. This versatile antenna swivels on ball and socket in any direction. Gold spirals, plastic base blend with any room. LIST... \$14.95

**New...
For every
TV
owner**



Hi-Lo Model 404 Channels — 2-83.
NEW INDOOR ANTENNA
that swivels with a gentle touch of your little finger. Dipoles swivel on ball and socket in every direction. Golden spirals and decorative plastic base blend with all furniture. RECEPTION IS GUARANTEED. LIST... \$12.95

*name upon request



Hi-Lo Model 101 — Channels 2-13.
The original and world famous antenna that is wanted, demanded and used for GUARANTEED FINEST RECEPTION. No rods to adjust. Provides clear pictures faster. LIST... \$9.95



Hi-Lo Model 303 — Channels 14-83.
The UHF ANTENNA with the highest signal gain that is specially designed for ALL UHF areas. Luxurious gold upright and crossbar. LIST... \$5.95



Hi-Lo Model 202 — Channels 2-83
PEAK PERFORMANCE which is unsurpassed is guaranteed with this antenna... for ANY and EVERY area. The gleaming gold upright, shiny spirals, bakelite base, aluminum bars, modern design

... all make this YOUR BEST ANTENNA BUY.

LIST... \$9.95

INSIST ON THE GENUINE Hi-Lo Spiral Antennas!
Known and accepted everywhere, Hi-Lo is manufactured and GUARANTEED by the best antenna manufacturer in the world. Hi-Lo is consumer accepted and approved.

Hi-Lo

TV ANTENNA CORP.
1122-26 Newport Avenue
Chicago 13, Illinois

"GRIP" PRESENTING THE *New* SPINTITE[®] WRENCHES

PATENTS PENDING

FINEST QUALITY
STEEL SHANK
AND SLEEVE
•
BRIGHT PLATED
FINISH
•
STRONG
PLASTIC HANDLE

WITH THE EASY "FINGER-CONTROL"
GRIP AND RELEASE ACTION
FOR THOSE
HARD-TO-GET-AT PLACES —

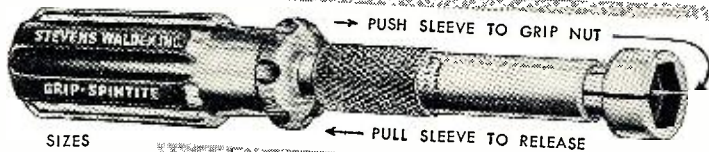

SIZES
3/16" TO 1 1/16"

BY THE MAKERS OF
THE ORIGINAL
SPINTITE
WRENCHES
OVER 150 STYLES
AND SIZES

ONE HAND OPERATION—

- GRIPS nuts or bolts of any material
- HOLDS firmly in any position
- TIGHTENS nut or bolt securely
- RELEASES at the pull of the fingers!

Write for
catalogue

STEVENS WALDEN Inc.

450 SHREWSBURY STREET — WORCESTER, MASSACHUSETTS
MAKERS OF WORLD-FAMOUS HAND TOOLS FOR OVER 50 YEARS

being described as "theater music-drama." Whatever the form, his works are highly interesting and this is no exception.

Based on the old fable of the King and the Wise Woman, his musical means is, as usual, economical to put it mildly. There is here a suggestion of folk music, but interspersed with it are odd oriental motifs. All is kept in the simplest form with a minimum of chromaticism, the contrasts of the work coming in his rhythmic devices and his fabulous use of meter.

This *Angel* production is handsomely mounted, having such stellar personnel as Orff himself as the speaker, Marcel Cordes as the "King," the lovely Elizabeth Schwarzkopf as the "Wise Woman," and Rudolph Christ as "The Man with the Donkey," and other well-known singers. Sawallisch does a splendid job of conducting and integrating the myriad elements into an integrated musical whole.

The sound is simply superb, another prime example of the *Angel* recording technique used for opera. All vocal elements are brilliantly articulate in an acoustic situation which combines, in an odd way, spaciousness with a sense of intimacy. Superbly quiet surfaces aid in maintaining an almost tangible feeling of "presence." One could spend pages describing this work and couldn't begin to convey the true flavor of the score. It is something you must hear for yourself, with an open mind and a willingness to absorb Orff's musical thought gradually.

WAGNER

DER FLIEGENDE HOLLANDER

Beyreuth Festival Chorus and Orchestra conducted by Joseph Keilbert. London XLLA42. RIAA curve. Price \$14.94. Three discs.

The second complete version of this opera to appear on LP, it is clearly the recording of choice even though the *Decca* recording had much to recommend. With such sympathetic personnel as Astrid Varnay as "Senta," Hermann Uhde as "Der Hollander," Rudolf Lusting as "Erik," and Ludwig Weber as "Daland," you could hardly go wrong. When you add the precision and authority of the Bayreuth Chorus, the authentic atmosphere of the Bayreuth acoustics and the inspired conducting and direction of Joseph Keilbert, you have a highly exciting recording which invokes a mental picture of what it must be like to attend the Bayreuth Festival in person.

The usual audience noises of coughing, etc., are minimal here and the sound itself, while a little shrill in sections and not up to the usual high *London* standard, is generally quite good. With complete recordings of this work few and far between and with the quality which obtains, this would certainly be a safe buy—reasonably safe from early obsolescence. Highly recommended to the lovers of Wagnerian opera.

MOZART ARIAS

Hilde Gueden, soprano. London LL1508. RIAA curve. Price \$3.98.

A grab-bag of arias from such as "Don Giovanni," "Die Zauberflöte," "Le Nozze di Figaro," etc., Miss Gueden gives further evidence of her mastery of the Mozart idiom. She may have mannerisms which annoy some people, but few will deny that she has real beauty in her voice and in general a knowing way with the acting requirements of the various roles. The engineers here afford the decorous Miss Gueden lovely smooth sound of compelling beauty, her rich timbre flawlessly captured.

That is all for this month, but with all the "goodies" pouring from the record presses, I hope to have another lot of discs to tempt your ears and open your wallets.

HICKOK

Model 605A

DYNAMIC MUTUAL CONDUCTANCE

Tube Tester

Handy Size Portable

- Popular—Accurate—Dependable.
- Large 5" easy-to-read meter.
- Accurately tests tubes in micromhos.
- Built-in 20,000 ohms per volt DC multimeter measures capacitance, inductance, volts, current and decibels.
- Write for technical details...

THE HICKOK ELECTRICAL INSTRUMENT CO.
10524 Dupont Avenue • Cleveland 8, Ohio

PROVEN!



LIST
9⁹⁵ COMPLETE

WUERTH TUBE-SAVER

TRIPLES LIFE OF ALL TUBES

The "Thermal Cushion Action" principle of the Wuerth Tube-Saver has been proven in military use... Now available for use to extend Television, Radio, and Hi-Fi Tube Life 3 times. Simple to operate... Just plug it in for complete results.

Now in Great Demand for Greater Profits

The Wuerth Tube-Saver is now being distributed in Major Cities throughout the country.

NEW YORK	—Emerson, N. Y.
CHICAGO	—Allied Radio Corp.
PHILADELPHIA	—Radio Electric Service Co.
DETROIT	—Radio Specialties Co.
CLEVELAND	—Emerson Radio of Ohio
WASHINGTON	—Sylberne Radio & Electronics Co.
BALTIMORE	—American Distributing Co.
NEWARK	—Emerson New Jersey Inc.

Wuerth Tube-Saver Corp.

9125 Livernois Ave., Detroit 4, Mich.

Progress in FM Multiplexing

By **HERMAN BURSTEIN**

A number of installations have been made. Technical know-how, service experience being gained.

FM MULTIPLEXING was described in the November, 1955 issue of this magazine as having emerged from the developmental and experimental stage (the FCC bestowed official approval in July, 1955) and as being on the threshold of commercial exploitation. In the interval since then, steady progress has been made, pointing to the technical and commercial success of this new method of broadcasting and giving increased promise of the use of the multiplex technique for stereo programs.

The reader is referred to the earlier article for an explanation of how multiplex works, history of its development, its potential for stereophonic sound, and methods of preventing unauthorized reception in connection with subscription service. Here it may be said briefly, by way of review, that FM multiplexing permits two audio channels to be transmitted, and received, on a single carrier. Properly designed equipment can detect the second (multiplex) channel alone or can detect the main and second channels simultaneously for stereo purposes. The technical conditions for successful multiplex transmission insure that the highest standards of audio reproduction are met with respect to frequency range, distortion, and signal-to-noise ratio. The method of transmission is a compatible one in the sense that there is no interference with main channel reception by ordinary FM receivers.

As of this writing, *Multiplex Services Corporation* of New York City, one of the principal pioneers in the field, has completed seven transmitter installations. *Harkins and Herschfield* of Los Angeles, the only other firm engaged in the installation of multiplex transmitters, has also made a number of installations. While installations to date are few in number, they nevertheless represent an important accumulation of know-how and actual service experience in a new technical art. This know-how will undoubtedly permit an acceleration in the rate of multiplex installations.

It must be realized that a multiplex installation at an FM station already in operation is not a matter of putting in entirely new transmitters but of integrating, as a complete system, the new multiplex equipment and existing portions of the FM transmitter. The older equipment, while satisfactory for

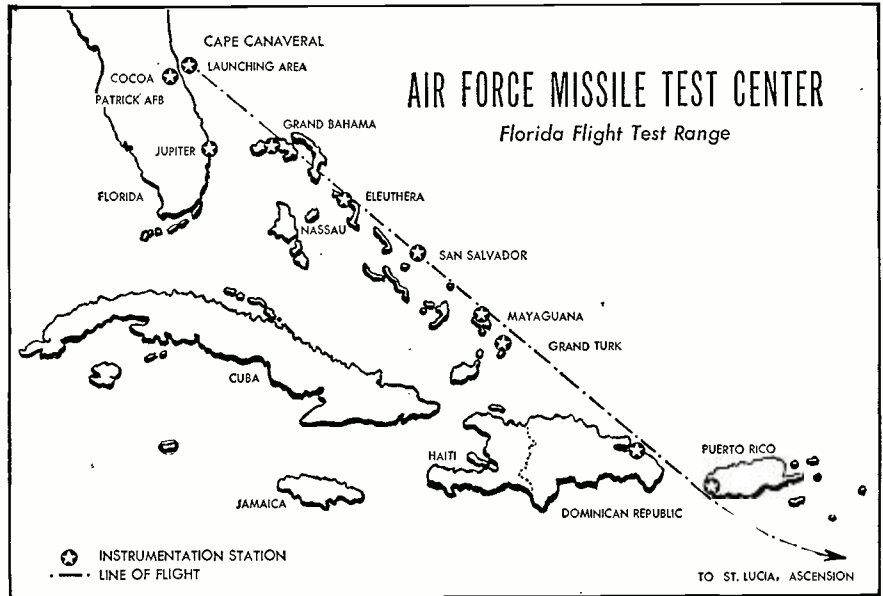

RCA

ANNOUNCES OPPORTUNITIES

In Guided Missile Test Instrumentation For Electronic Technicians

At the following locations

PATRICK AIR FORCE BASE, FLORIDA

Engineering development technicians
Radar
Communications
Test Equipment

CAPE CANAVERAL

Radar
Radio
Telemetry
Timing
Telephone
Optics

*Enjoy pleasant Florida living and working at these locations.
Liberal company benefits. Relocation assistance.*

INTERESTING DOWN-RANGE ASSIGNMENTS

Radar
Radio
Telemetry
Timing
Telephone
Optics

These positions are located on the Islands shown on the map above. Salary, 30% differential, meals and lodging furnished. Return to U.S. every 3 months.



*For information and arrangements for personal interview,
send complete resume to:*

Mr. H. C. Laur
Technical Employment, Dept. N-16C
Missile Test Project
RCA Service Co., Inc.
P.O. Box 1226, Melbourne, Florida



RADIO CORPORATION of AMERICA

KESTER



Absolutely non-corrosive and non-conductive, KESTER "RESIN-FIVE" CORE SOLDER contains an activated type of resin that gives you that fast, positive action on all your jobs . . . including the most difficult.



KESTER SOLDER COMPANY
4235 Wrightwood Ave. • Chicago 39, Ill.
Newark 5, N. J. • Brantford, Canada

SOLDER

You can forget about chassis "BITES"



\$29.50
From stock of your jobber.

Adjust-A-Volt

LR-5 VARIABLE TRANSFORMER

No wonder thousands of servicemen rely on the LR-5. It can be used as a variable or isolation transformer. You can drop line voltage to check for a faulty oscillator or you can cook a set to test intermittent parts with it, without chassis touching jitters. Write for catalog.

STANDARD ELECTRICAL PRODUCTS CO.
2238 E. THIRD ST. • DAYTON, OHIO

Sandy Says!
For **PEAK PERFORMANCE**
Anchor
C-202
Two-Set
TV Coupler

Use 1 antenna
for 2 TV sets

Size,
3 3/4" x 1 3/4" x 1"

Transformer Type Coupling Gives MAXIMUM . . .

- Impedance Match
- Signal Transfer
- Two-Set Isolation

AT YOUR DISTRIBUTOR OR WRITE:

anchor products co.
ELECTRONIC COMPONENTS
2712 W. Montrose • Chicago 18, Ill.

its original purpose, usually does not incorporate the refinement of design and standard of performance required for satisfactory, distortionless multiplex broadcasting. Accordingly, the past year or so has been devoted in large measure to adapting various types of FM transmitters to multiplex service and making changes in the design of multiplex elements or adjustments in transmitters to obtain optimum results.

Three of MSC's installations have been in full commercial operation, supplying background music service, for more than six months, while the others are in the testing stage or are rendering non-music services. The first three to go into full multiplex operation, and which have been using the second channel for sale of background music to restaurants, hotels, etc., are WFLY in Troy, N. Y., WGH in Norfolk, Va., and WFNC in Fayetteville, S. C.

Purchasers of background music rent fixed-frequency multiplex receivers from the FM station. The station buys them either from the maker of multiplex transmitting equipment or from a receiver manufacturer licensed by the former.

Fig. 1 shows a "multicast" receiver manufactured for MSC by *Browning Laboratories*. The Model MR-3A incorporates the following elements: (1) a crystal-controlled FM tuner; (2) a multiplex adapter, which receives its signal from the FM tuner; and (3) a 3-watt audio amplifier, which is sufficient to drive at least six average speakers at normal background music level. The adapter includes an automatic muting device which is under the control of the station. Sensitivity of the MR-3A is 2 microvolts for 20 db quieting, and signal-to-noise ratio is better than 50 db under normal conditions. Clearly shown in Fig. 1 are the volume control, "off-on" switch, and pilot light. Bass and treble controls are also included, these being accessible through the two holes that can be seen at right side, bottom, of the receiver. These holes may be capped to prevent tampering with the controls. Also, the volume control knob may be removed and the chassis hole capped to prevent unauthorized operation and adjustment.

Another example of a multiplex FM receiver is shown in Fig. 2. This unit, manufactured by *Collins Audio Products*, has recently been put into pilot production. Features of the receiver

Fig. 1. Multicast receiver made by *Browning Labs.* for *Multiplex Services Corporation.*

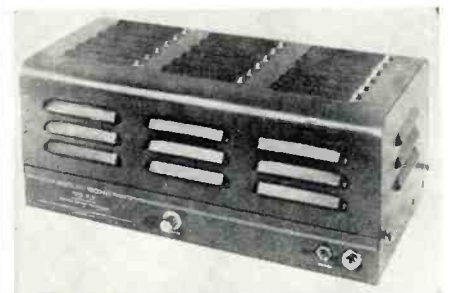

include a cascode crystal-controlled front end, wideband i.f. amplifier and discriminator, six-watt push-pull audio circuit, provision for selective muting of either main carrier or subcarrier, automatic background squelch, and large power components.

Multiplex has proven itself able to cover very substantial distances with quite moderate amounts of power. Thus in the case of WFLY, although the transmitter is located in mountainous terrain and has an effective radiated power of only 12 watts, good multiplex reception is obtained at distances in excess of 50 miles. Hence multiplexing need not be in the nature of a local service but can cover very substantial areas as the demand arises.

The commercial uses visualized for the multiplex channel are many in addition to the sale of background music. One of *MSC's* installations, WNYC in New York City, will use the second channel to broadcast weather information in cooperation with the United States Weather Bureau. These weather broadcasts, of continuous type, are of vital importance to transportation services, municipal agencies, and similar groups.

Still in the conceptual stage are other uses. Various groups in the field of education, including several universities, are investigating multiplex as a medium for teaching non-visual courses such as history and philosophy. Many new communications services are contemplated, such as relaying AM and FM network broadcasts, carrying teletype messages, carrying news distributed by present wire services, linking the branches of giant corporations, etc.

All of the aforementioned uses are in the nature of commercial rental of the multiplex channel for private or otherwise limited use. What of public service (free) stereo broadcasts? While it has been expected from the outset that this development would come later in time, awaiting the widespread adoption of multiplexing by FM stations, indications are that the time is not too far away, especially in view of the relatively great impetus gained by stereo reproduction in the past year, aided by the advent of stereo tape. According to W. S. Halstead, head of *MSC*, at least two stations have plans for putting stereo broadcasts on the air *via* multiplex rather than by the present method, which em-

Fig. 2. Top-chassis view of a multiplex receiver made by Collins Audio Products.

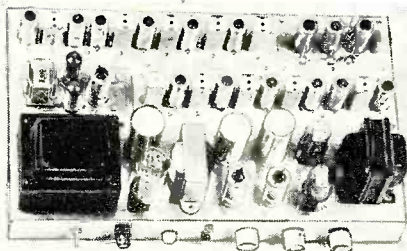

NOW THE *improved*

SHURE

UNIDYNES

the world's most widely used fine microphones

PROVIDE

- 41% higher output!
- The perfect microphone choice for use with low-gain P. A. systems and tape recorders... in addition to their famed usage in finest quality public address systems.

The best

is even better!

The unidirectional dynamic Unidynes are now more than ever your best choice in those installations where feedback is a problem, and for all fine-quality public address, theatre-stage sound systems, magnetic recording and remote broadcasting—where critical standards call for the finest-quality microphone operation.

Another example of the continuous creativity of the Shure Research and Development Laboratories.

55S Unidyne List Price \$79⁵⁰

556S Broadcast Unidyne List Price \$120⁰⁰

IN ELECTRONICS SINCE 1925

The Mark of Quality

SHURE

SHURE BROTHERS, INC.

Microphones ~ Electronic Components

210 HARTREY AVENUE • EVANSTON, ILLINOIS

ONE OUT OF FOUR
OUTDOOR
INSTALLATIONS
ARE MADE WITH

AMPHENOL

TWIN LEAD



More than 25% of all outdoor tv installations—more than 5,000,000 installations in the United States alone—have been made with AMPHENOL Twin Lead! These tremendous sales figures reflect the popularity of AMPHENOL Twin Lead with Dealers, popularity founded on these important advantages:

PERFORMANCE: Good TV pictures depend upon the *reliability* of the entire set installation—AMPHENOL Twin Lead is the *strongest link* in any system, a guarantee of better picture quality!

CUSTOMER SATISFACTION: Complete customer satisfaction is your key to *repeat sales*—AMPHENOL Twin Lead provides you with this key to better business, better profits!

GREATER PROFITS: As every Dealer and Serviceman knows, AMPHENOL Twin Lead provides *plus profits* on every sale—fair mark-ups to fair list prices!

EASY-TO-USE-HANKS: Complete customer satisfaction is your key to *repeat sales*—AMPHENOL Twin Lead Hanks make selling and installing easier. Popular lengths of 25, 50, 75 and 100 feet; also reels of 500 and 1000 feet.

Over 5,000,000 AMPHENOL outdoor Twin Lead Installations Have Shown The Way to Quality!



AMPHENOL ELECTRONICS CORPORATION
chicago 50, illinois

www.americanradiohistory.com

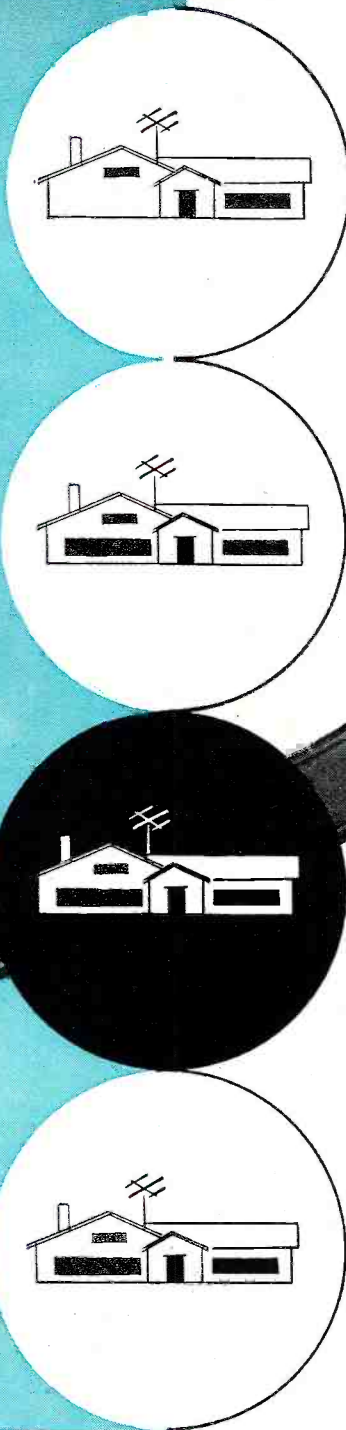

plays the FM and AM transmitters of a single station to carry the two channels of a stereo program.

One of these stations, in Boston, expects to allot several hours a week to stereo, although most of the second channel time will be devoted to commercial subscribers. The other station is a proposed new one in New York City, which will broadcast on a similar basis. At least one major FM tuner manufacturer, states Halstead, is interested in sponsoring stereo broadcasts.

Although stereo FM is on the horizon, it is still too early to go out looking for multiplex tuners. These are not yet on the market. There are several standard FM tuners which have an extra output jack, connected prior to the de-emphasis circuit, that is intended to feed a multiplex adapter when this item becomes available. However, the performance of these tuners on multiplex is not generally as good as special separate multiplex receivers. According to Halstead, tests of these tuners show that they usually exhibit sufficient non-linearity, usually in the discriminator, i.e., or limiter stages, to produce crossmodulation between the main and multiplex channels to the detriment of the multiplex channel.

On the other hand, several leading makers of FM tuners are designing units which will present undistorted multiplex information to an adapter. At least one of these manufacturers is at work on a complete tuner, which will detect audio on the second as well as on the main channel.

At present, *MSC* is making multiplex tuners available only to FM stations for rental to their subscribers and these are crystal-controlled fixed-frequency units. However, it is visualized that as stereo broadcasts come on the scene, multiplex adapters and tuners of satisfactory design will be marketed by a number of FM tuner manufacturers.

It is still too soon to say to what extent stereo broadcasts will ultimately be on a free or subscription basis. If on the latter, *MSC* has made provision for coded broadcasts which will afford full protection against reception by non-paying would-be listeners. The reader is referred to the November 1955 article for details on coded multiplex broadcasts. —50—

NO HORIZONTAL SYNC

By JAMES A. McROBERTS

The complaint on the RCA KCS 81 chassis was no horizontal sync. Test to be sure that the 82 $\mu\text{fd.}$ capacitor, C_{165} , is not open by bridging it with another capacitor of about the same value. Perform this test with the receiver operating.

If the sync is restored during the bridging, replace C_{165} which couples the sync to horizontal control tube from the horizontal sync separator. Since some differentiation is performed by this capacitor, do not use a large capacitor for the test bridging or as a shunting capacitor. —50—

Save that Capacitor

By JACK A. JONES

Noisy or intermittent tuning capacitors can be "cleaned" electrically.

DO YOU have a receiver that is noisy or scratchy during tuning, or that cuts in and out as you tune it over certain stations—usually your favorite ones? If you do, the cause is almost sure to be bent plates or filings and dirt accumulated between the plates of one or more sections in your main tuning capacitor.

The method described here can put such a tuning capacitor back into service. It will apply equally well to any capacitors you may have in your junk box that are just right for some new project or for use as replacements, except for their noisy or intermittent condition.

First, blow out all of the accumulated foreign matter that you can from between the plates. If the capacitor is mounted in a receiver and in service, it will be necessary to isolate it from the rest of the receiver by removing all wiring going to it, also all wires connecting one section or set of plates on the tuning unit to others.

Now, connect a s.p.s.t. switch and a 100-watt, 117-volt lamp in series with each other; then connect this combination in series with the tuning plates. One connection is made to the rotor plates; the other connection is made to the stator plates. Before applying power, be sure to insulate the tuning shaft to prevent shock.

Now, with the shaft insulated, turn on the power switch and slowly rotate the capacitor through a complete cycle. If there are bent plates, the lamp will light when the plates make contact. It is then easy to cut the power and straighten the plates with a screwdriver. Filings and dirt, which make momentary contact between plates during rotation, will burn out. —50—

Applying line voltage across a noisy tuning capacitor, or one that is intermittently shorting, with the circuit shown, will pinpoint unwanted shorting and even burn out some of these shorts.

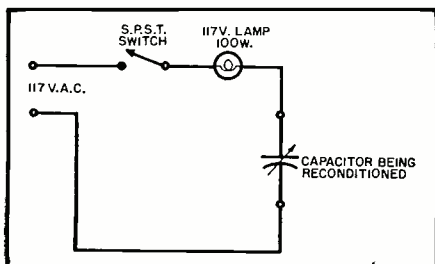

March, 1957

PHAOSTRON

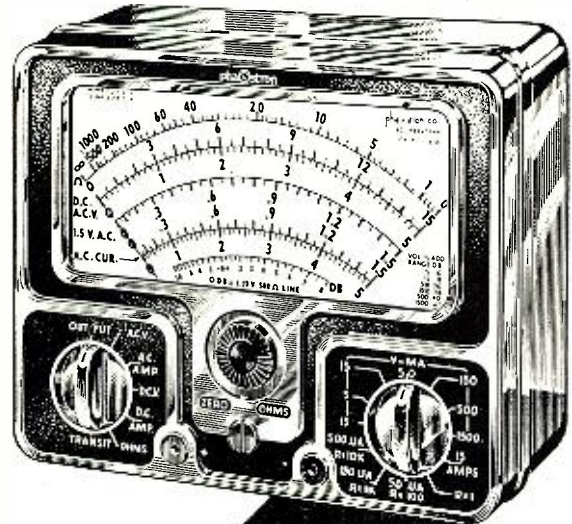

Here Is The Best Value Ever Offered In An Electrical Measuring Instrument...

METER PROTECTION

The meter movement is protected up to 1000 times overload by rectifier network.

"555A"
A.C.-D.C. V.O.M.

ONLY THE PHAOSTRON "555A" V.O.M. (VOLT OHM MILLIAMMETER) MEASURES A. C. and D.C. CURRENT and VOLTAGE AS WELL AS RESISTANCE AND HAS ALL THESE FEATURES:

- Unbreakable Metal Case of Highly Polished Chrome
- Separate Range and Function Switches
- Anti Magnetic Shielding
- Easy-to-Read, Large 4-Color Scales
- 43 Unduplicated Ranges
- Only 2 jacks
- 3% D. C. ... 4% A. C. Permanent Accuracy

ACCESSORIES AVAILABLE

Genuine Leather Carrying Case \$7.95
Panel Mounting Adapter \$1.50

"555A" V. O. M. complete with probes and batteries at your Parts Distributor

\$44⁵⁰

Other Fine Phaostron Products

MODEL "777"—Vacuum Tube Voltmeter... 42 unduplicated ranges with permanent accuracy—3% D.C., 5% A.C.

CUSTOM PANEL INSTRUMENTS—2½", 3½", 4½", 6"... all shielded by their metal cases from stray magnetic fields. 2½" and 3½" models available in round or square face.

PORTABLE LABORATORY INSTRUMENT...with double probe outlets and full overload protection.

RUGGEDIZED AND SEALED PANEL INSTRUMENTS...available in 1½" (Square Bezel) and 2½", 3½", 4½" Round Bezel models in AC, DC or Null Indicators.

Write today for full details or ask your dealer

PHAOSTRON INSTRUMENT AND ELECTRONIC COMPANY
151 Pasadena Avenue, South Pasadena, California

WIDEST CONTROL COVERAGE EVER

...With New IRC Dealer Parts Stocks

New IRC Dealer Parts Stocks put at your fingertips the greatest control coverage ever offered at any price. From these basic stocks of standard parts, you can now assemble most of the controls you need. You're all set for faster service . . . you're safe with IRC quality.

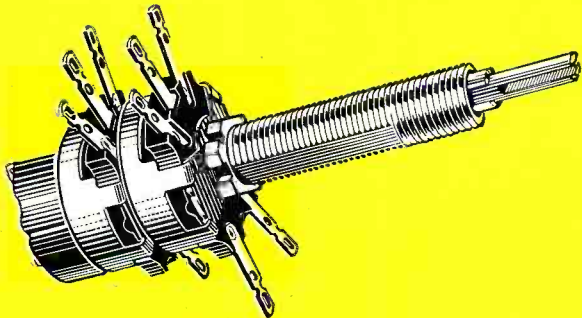

325 EXACT DUPLICATE CONCENTRIC DUALS

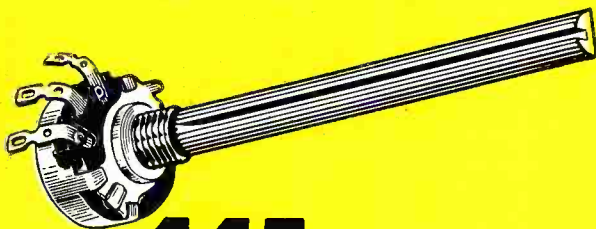

445 SINGLE CARBON CONTROLS



39 SINGLE WIRE-WOUND CONTROLS

TOTAL COVERAGE 809 DIFFERENT CONTROLS COVERING OVER 3700 MANUFACTURERS' PART NUMBERS

"QUICK-AS-A-WINK" ASSEMBLY

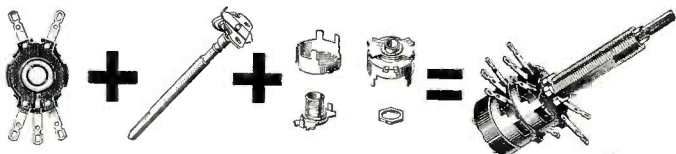

BASE-ELEMENT SHAFT INTERCHANGEABLE PARTS COMPLETE CONTROL

Send coupon for all the facts ➔

Whenever
the Circuit Says



**INTERNATIONAL
RESISTANCE CO.**

Dept. 481, 401 N. Broad St., Phila. 8, Pa.
In Canada: International Resistance Co.,
Ltd., Toronto, Licensee

Spot Radio News (Continued from page 18)

vent this. The FCC, said the chairman, is saddled with more procedural time-consuming requirements than any other Federal agency.

But, added the Commission's headman, whether or not the Commission is able to catch up with its work schedules, there is every indication that the communications industry will, in practically every line, continue its present high rate of expansion and development.

AN ELECTRONIC INSTRUMENT that continuously measures the clearance between the rotating and stationary blades inside a steam turbine has been developed by the Bureau of Standards. The detecting element of the system is a mutual-inductance micrometer probe in printed-circuit form on a ceramic base that resists high-temperature steam erosion inside the turbine.

One of the problems in steam turbine operation, the Bureau's experts explained, is that of maintaining safe axial clearance between rotating and stationary blades. The rotor and stator blade assemblies are supported respectively by a massive rotor and relatively thin outer casing. Thus transient thermal conditions can cause large differential expansions, possibly resulting in interference between the blades. In the Bureau's approach, the rotor position indicator permits accurate determination of blade clearance by measuring the axial distance from the shrouding around the rotor blade tips to the base of the outer stator blades. Since conditions at the blade tips are extremely severe—high velocity steam at 700° F—a temperature resistant probe is essential.

A typical mutual inductance probe contains two coplanar, coaxial coils wound on a dielectric core. An r.f. source that is regulated with respect to the product of the frequency and current energizes the primary coil. The a.c. coil voltage induced in the secondary coil depends on the distance from the probe to a nearby electrically conducting reference plate. Suitable electronic circuitry then detects and amplifies the output voltage from the secondary coil, and the amplified voltage is indicated on a meter calibrated to give the probe-to-surface measurement in inches or centimeters.

To measure the transverse motion of the shroud band, the energized primary winding induces voltages in two secondary coils that cover separate halves of the primary winding area. These half-windings are connected in series opposition so that there will be no voltage output when the band around the blades is centered over the probe. This band corresponds to the reference plate of the typical mutual inductance probe. Eddy currents induced in the band as it approaches the coil assembly set up an opposing field that reduces the mutual inductance between windings. When the band is directly over the center of the probe, the inductance in each half-winding is reduced by an equal amount and no net output results. If the band moves transversely so that the half-windings are unequally covered, the inductance of one coil increases and the other decreases. As a result, there is a voltage output which is nearly a linear function of the transverse motion away from the center of the probe. However, a change in radial clearance (when the band moves toward or away from the probe) changes the sensitivity of the probe and introduces error in the measurement. To measure axial motion independently of radial shift, a voltage is generated in the probe which controls the amplitude of the exciting current. This voltage is proportional to the sensitivity for transverse motion, decreases as the radial clearance increases, and remains constant as the band moves transversely.

The coil configuration is printed on a steatite plate, 1/8-inch thick, mounted at the top surface of the probe housing. The printed pattern of conductors is glazed to protect the silver from erosion by steam. To minimize crossover connections, conductors are printed on the back as well as the front of the plate and connections are made

through small holes filled with conducting material. The outgoing leads are brought up through tubes which have been fused into holes in the edge of the plate using a conducting joint compound. The tubes are compressed and spot-welded over the wires.

Under normal turbine operation the probes may last several hundred hours, but when the turbine is frequently subjected to severe transient conditions, such as sudden reversal of direction, the life of the probes may be as short as 30 hours.

A NEW ANECHOIC CHAMBER featuring an elaborate acoustic treatment of glass fiber wedges covering walls, ceiling, and floor, has been added to the sound lab of the Bureau of Standards.

The glass fibers are matted, and each wedge is 40 inches deep from its tapered end to its 8 by 24-inch base. Held in shape by an open wire netting, the wedges are fabricated in units of three each. The units were mounted so that the tapered edges of each unit could point into the room at right angles to those of the adjacent units. The units were attached to a wooden cellular framework, which also served to provide a 6-inch airspace between the wall and the bases of the wedges. To attenuate electromagnetic disturbances from the outside, such as radiation from nearby television stations, the interior faces of the walls were lined with a .0003" layer of copper shielding.

The working space in the room is approximately 21 by 16 by 10 feet. The door, 48 inches thick, has the same acoustic treatment as the walls and moves easily in and out along overhead rails. A horizontal, interlaced steel-cable net makes it possible to walk about in the room just over the floor wedges. About 3/32 inch in diameter, the individual cables were attached through compression springs to I-beams that ring the lower part of the room.

Some of the uses for the room include: secondary free-field calibration of microphones; research in the scattering of sound; calibration of sound-level meters; testing of hearing aids; measurement of noise produced by certain types of apparatus, such as ventilating fans, etc.

THE ASSORTED PROBLEMS facing the Commission, stressed by the FCC's chairman in his formal statement for the year, were underscored in the continuing slow processing of new grants, as this column was being prepared.

It was hoped that action would step up during the summer months, when the allocation situation might improve.

In the meantime, only the stations listed on page 16 received the green light to go on the air.

A STRIKING APPLICATION of closed-circuit television in the study of cancer cells, that may reveal vital clues to effective medication, was disclosed recently at the National Institutes of Health, Bethesda, Maryland.

Employing an ultraviolet-sensitive TV camera tube, a high-power microscope, and an electronic scope, it was reported that direct observations and oscillographic measurements of the metabolism of living cells can now be made. For the first time, it was said, researchers can observe and take motion pictures, simultaneously, of chemical activity within living cells.

Heretofore, scientists on the project declared, the study and observation of ultraviolet-treated specimens represented a long and laborious process, due to the lack of a practical medium of direct observation. The new technique was said to be the answer to the problem.

In operation, the ultraviolet absorption image, viewed by the TV camera through a microscope, is converted to an electronic signal by the ultraviolet camera tube. The signal is amplified and then viewed on the screen of a TV monitor, a few feet away. Any one of 525 horizontal scanning lines can be selected and analyzed by a scope, which produces on its picture tube, in two ordinates, a tracing of the absorption characteristics of the specimen.

Here truly is a towering contribution to the medical world, thanks to the ingenuity of our electronic scientists. L. W.

MOST CONTROL COVERAGE PER \$...With New IRC Dealer Parts Stocks

\$15 worth of coverage for every \$1 you invest!

No wonder IRC Dealer Parts Stock #21 is the biggest bargain in control history. Two master stockers contain all the parts you need for coverage on 469 different controls. This wide coverage would cost you \$752 in assembled controls, but Parts Stock #21 gives it to you for only \$49.90!



Dealer Parts Stock #21—Only \$49.90

Dealer Parts Stock #22 Widest coverage ever available in a parts kit!

Dealer Parts Stock #22 sets you up for practically every control you'll need. 809 different controls altogether, including special wire-wounds. It would take \$1245 to buy the same coverage in factory controls, yet Dealer Parts Stock #22 sells for only \$99.90!

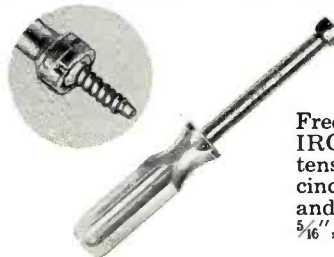

IRC TENSION-GRIP NUT DRIVERS

Free a hand . . . save your temper with IRC's non-magnetic nut driver. Vise-like tension band makes driving or removing a cinch. Nuts and hex screws won't twist—and they can't drop. Six socket sizes: 1/4", 5/16", 11/32", 3/8", 7/16" and 1/2".



INTERNATIONAL RESISTANCE CO.

Dept. 481, 401 N. Broad St., Phila. 8, Pa.

Send the facts about the biggest control coverage bargain in history.

NAME _____

DEALER _____

ADDRESS _____

CITY _____ STATE _____

NEW AUTOMATION TV TUBE TESTER CAN'T BECOME OBSOLETE

ONLY 3 SOCKETS!

to test all
TV tubes!



INSERT THIS CARD

Eliminates 25 switches and 30 sockets
saves 80% of testing time

DynaMatic tube tester uses perforated plastic cards to automatically set up socket pin connections & test voltages

- PERFO Cards are made available to test all new tubes as fast as they appear in TV sets.
- No more multiple socket panels or roll charts that become obsolete when new tubes are introduced.
- Smallest and lightest Gm tube tester ever produced. Take it with you on ALL house calls.
- Permits full-complement tube testing which must result in increased tube sales.
- Lots of free advertising when customer sees his tubes tested on automatic equipment.
- DynaMatic is a dynamic mutual conductance tester—NOT an emission checker
- Shows percentage of rated mutual conductance on GOOD-BAD scale.
- Measures mutual conductance in micro-mhos on 2 ranges: 0-6000, 0-18000.

SEE IT AT YOUR JOBBER THIS MONTH

TELETEST

TeleTest Instrument Corporation

121-08 14th Road
College Point 56, New York

CIRCUIT RELIABILITY

By PAUL PENFIELD, JR.

*Points to remember when
designing gear. Success
depends on small things!*

MOST readers of this magazine are people who are very apt to build something new and different, at one time or another. This magazine constantly features articles on new and unusual electronic devices and it is only natural that you, the reader, will, at some point, go "one step further" and design your own unit.

Your actions in designing and building the apparatus will probably be roughly as follows: (1) get the idea—the "brainstorm"; (2) design the original circuit; (3) build the circuit, and find plenty of unexpected "bugs"; (4) work hard "de-bugging" the circuit; (5) freeze the design once the bugs are removed; (6) find additional bugs, and remove them; and (7) after operating the device for a while, find still more difficulties.

This article will cover some of the important points in eliminating troubles found in stage (7). By prudent design and construction, you can help insure reliable operation for some time to come.

If you want to mass-produce the device, want to write it up for a magazine such as this, or want really fool-proof operation, then some care must be taken. Many pitfalls await the person who builds only one of a device he designed himself.

Some of the categories overlap slightly, but all are important.

(1) *Tolerances of components:* Is the device operation critical with regard to some component? If, say, a new tube is used, will a re-alignment be necessary? If so, perhaps some further work could eliminate this trouble; perhaps not. If the device is to be produced in any quantity, normal tolerances on components must not cause bad operation. For example, if certain resistor values are critical and this can't be avoided, use stable deposited carbon resistors, to prevent changes due to aging.

One way to check for this trouble is to go around shunting resistors with a higher value to lower the resistance value somewhat—the same for capacitors. If the operation changes much, watch out!

Will your device work if transistors are replaced? Transistors are perhaps the widest-tolerance component today—gain and cut-off current can change several hundred per-cent from one unit to another. If replacing one transistor with another causes changes in opera-

THE FINEST TELEVISION AND FM ACCESSORIES by

Dynamic ELECTRONICS

FOR BETTER RECEPTION Tested and specifications certified by New York Testing Laboratories, Inc.

Designed especially for Tape, Wire and Disc Recorders & Play Backs HIGH FIDELITY, PHONOS, AMPLIFIERS, FM & AM TUNERS and TELEVISION RECEIVERS.

Guaranteed elimination of noise picked up thru the line caused by motors, ignition, neon, diathermy, lighting & heating equipment, transmitters and electrical appliances.

- DUAL FILTER ACTION.
- PASSES ALL FREQUENCIES ABOVE 10 KC.
- AUTOMATIC ATTENUATION ABOVE 10 KC.

Model DF200 Sale Price \$6.95.

There is a Dynamic accessory or service aid for practically every need. Full line catalog on request.

Manufactured By...
DYNAMIC ELECTRONICS-NEW YORK, INC.
Forest Hills, Long Island, N. Y.

Another Sencore Time-Saver

SENCORE TRANSISTOR CHECKER

Model TDC22

NOW WANTED and NEEDED by EVERY SERVICEMAN

Quickly and accurately checks all transistors and crystal diodes.

Provides these 4 important checks on transistors:
OPEN • SHORT • CURRENT GAIN • LEAKAGE
Checks forward to backward resistance of diodes.

★ Complete set-up chart and Instruction booklet attached to back ★ Will never become obsolete, with test leads, replaceable up-to-date set-up chart and gain control to vary battery voltage ★ Accurate and simple to operate — takes less than 30 seconds to test either TRANSISTORS or crystal diodes
★ Uses test leads which eliminates need of completely removing transistor from circuit.

At Leading Distributors Everywhere

Mfg by **SERVICE INSTRUMENTS CORP.**
171 OFFICIAL RD., ADDISON, ILL.

Only \$15.95 DEALER NET

POPULAR SENCORE PRODUCTS

- Transistor Tester
- Leakage Checker
- Filament Tester
- Voltage Regulator
- Bias Supply

BOOK -OF-THE- YEAR

FOR TRANSFORMER
BUYERS...

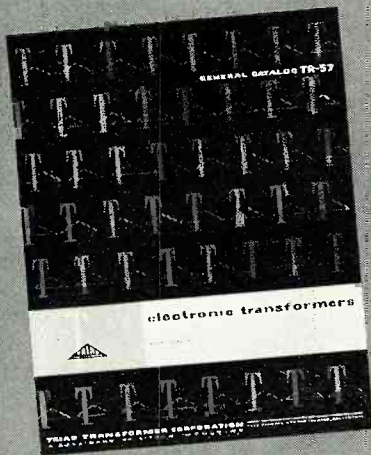

NEW TRIAD GENERAL CATALOG TR-57

Lists the complete line of transformers that have made TRIAD "the symbol of quality." Includes over 75 new items. Now available from your distributor or write...



4055 REDWOOD AVENUE
VENICE, CALIFORNIA;
812 EAST STATE STREET
HUNTINGTON, INDIANA

A SUBSIDIARY OF LITTON INDUSTRIES



tion, perhaps a circuit that depends less on transistor parameters would help.

Design your circuit so it can stand the tolerances expected.

(2) *Marginal operation:* Often control devices are made which barely operate, that is, the signal at some point is so close to the noise or drift level, that unless conditions are just right, the signal will be lost. Devices which require frequent fiddling to keep them working, to adjust for all kinds of changes going on, are next to useless. Be sure your d.c. amplifier, for instance, does not require constant "zero-ing" or adjustments. Make sure your device operates well at high temperatures, at high humidity conditions, with partially weak batteries, and with partially rundown components. Will it function when the line voltage is down to 105 volts?

(3) *Critical layout:* Physical layouts that are critical cause a lot of headaches, especially at high frequencies. If a sagging wire means the difference between operating on frequency and off frequency, perhaps you have some more work to do. Of course, normal intelligent layout should be followed, but if otherwise insignificant changes cause unreliable operation, look out.

Audio-frequency equipment suffers from this fault, too. Excessive hum pickup can be caused by improper lead dressing, as can high-frequency instability and oscillations.

Connect the ground leads so as to avoid ground loops, unless you have proved to yourself that their presence does not cause hum, oscillations, etc.

Critical parts placement can cause unexpected difficulty when someone else builds the apparatus from the schematic alone.

(4) *Ease of repair:* Unless this is a perfect device, it will need repair and/or improvements at some time. Make it so that all parts are accessible, and able to be removed without undue strain. Possibly you will want to include voltage points for diagnosing the trouble, or current jacks. Don't crowd all the components in so tightly that it's impossible to get a scope lead in.

(5) *Correct heat flow:* Heat is one of the circuit designer's worst enemies. Heat pouring out from a pair of 6L6's can easily cause some capacitors to lose their wax, can burn out resistors, and can destroy transistors easily. Use common sense in mounting the parts so that temperature-sensitive elements are away from heat-producing elements, and the latter are on the outside where they can dissipate their heat rapidly.

(6) *Maximum ratings:* This really should go without saying, but all components should be operated well within their maxima. This goes for transistors and tubes, too. Designers who wouldn't think of putting more than half the rated power into a resistor are sometimes surprised when tubes or transistors operated barely within their maximum ratings burn out. Watch out for excessive voltage on the

BUILD THE BEST— BUILD ALLIED'S OWN knight- kits

ALLIED stakes its 36-year reputation in the Electronics field on your complete success and fullest satisfaction with KNIGHT-KITS. Join the thousands who have discovered the ultimate in kit value in...



knight-kits

LOWEST COST because our giant buying power passes biggest savings on to you... you do the easy assembly and your finished instrument is equal in performance and appearance to equipment selling for several times the KNIGHT-KIT cost. (Easy Payment Terms available, too.)



knight-kits

EASIEST TO BUILD because KNIGHT-KIT "Step-and-Chek" instruction manuals are marvels of clarity—it's just like having a good instructor at your side. Proved professional design and premium quality parts help insure your building success.



knight-kits

MONEY-BACK GUARANTEE! When properly assembled, KNIGHT-KITs fully meet published specifications, or we refund your money.

WHEN YOU BUILD A KNIGHT-KIT
YOU BUILD THE BEST



For a Complete Selection of
Famous knight-kits
SEE PAGES 127-133

Available Only From
ALLIED RADIO
100 N. Western Ave., Chicago 80, Ill.

In A Class By Itself . . . Hallicrafters SX-101



Only
\$31.41
Per Month

Here's The top-flight receiver in the field, with seven ham bands on large slide rule dial: 1.8-2.4 Mc., 3.2-4.1 Mc., 7.0-7.3 Mc., 14.0-14.4 Mc., 21.0-21.5 Mc., 26.95-27.35 and 28.0-29.7 Mc., plus special 10³ Mc. position for W.W.V. Includes coverage of most important M.A.R.S. frequencies. A dual conversion receiver with the exclusive Hallicrafters upper/lower side band selection, tee-notch filter, 50:1 tuning knob ratio with absolute resetability, built-in precision 100 kc marker crystal, and illuminated dual scale S-meter. S-meter functions with AVC off. Has five steps of selectivity from 500-5000 cycles and precision temperature compensation; 52 ohm antenna input. Direct coupled series noise limiter, 14 tubes plus voltage regulator and rectifier. Sensitivity: -1 mv or less on all bands. Size: 20" x 10 1/2" x 16" hp. wt. 74 lbs.

4-6B Speaker, Wt. 13 1/2 lbs. — \$17.95

YOU NEED PAY ONLY \$39.50 DOWN; CASH PRICE IS \$395.00

Write for Our Complete List of Hallicrafter Models!

AT THE

**WORLD'S LARGEST DISTRIBUTOR OF AMATEUR
RADIO EQUIPMENT — PAY ONLY 10% DOWN!**

Get the Story on the

- GLOBE KING 500B: \$38.10 PER MO.
- GLOBE CHAMPION 300: \$24.47 PER MO.
- GLOBE SCOUT 65B: \$7.95 PER MO.
- GLOBE CHIEF 90 KIT: \$5.00 PER MO.
- SCREEN MODULATOR KIT: \$13.95
- TRANSISTOR CODE OSCILLATOR: \$3.95
- 6 METÉR CONVERTER: \$24.95
- SWR BRIDGE: \$16.95
- CONELRAD KIT: \$22.50

WRL

with printed circuit

Free 1957 Catalog — Over 18,000 Items



Please Send Me: Free Catalog . . . Hallicrafter Information
 The WRL Product Story . . . and your

Latest Reconditioned Equipment List:

NAME: _____

ADDRESS: _____

CITY & STATE: _____



R-3

ENGINEERING



Prepare for unlimited opportunities of the Electronic Age!

**B.S. DEGREE
in 27 MONTHS**

Earn your B.S. degree in 27 months at Indiana Technical College. Intensive, specialized course. Comprehensive training in electronics, television, advanced radio theory and design, math and electrical engineering. Modern laboratories. Low rate. **B.S. DEGREE IN 27 MONTHS** in Aero., Chem., Civil, Elec., and Mech. Engineering; in 36 MO. in Math., Chem., Physics. Also preparatory courses. G. I. appr. Enter March, June, Sept., Dec. Earn part of your expenses in Fort Wayne while studying. Catalog.

INDIANA TECHNICAL COLLEGE

937 E. Washington Blvd., Fort Wayne 2, Indiana

Please send me free information on B.S. ENGINEERING DEGREE IN 27 MONTHS as checked.

- Electronics Chemical Aeronautical
 Civil Mechanical Electrical

Name _____

Address _____

ZYTRON "QUALITY BRAND"

RADIO & TV RECEIVING

TUBES

BRAND NEW
INDIVIDUALLY BOXED

TerrificallY LOW PRICED!

Send TODAY for Complete Catalog

ZYTRON TUBE COMPANY

220 West 42nd Street - New York 36, N. Y.



capacitors, dissipation in transistors, etc., when components nearby in the circuit change value somewhat, perhaps by heating, or aging, or by replacement. Anticipate the worst possible conditions, at the highest expected temperature, and figure accordingly.

Be sure you know all the ratings—even such components as switches and plugs have reasonable current and voltage ratings.

(7) *Battery drain:* Often the experimenter builds a device and finds it works fine, except that he needs a new battery every few days. In order to avoid this disappointment on your battery-operated devices, make calculations of the expected life of the battery, or find out the life experimentally. (Refer, for example, to Langford-Smith's "Radiotron Designer's Handbook," pages 1272-1274 of the Fourth Edition.) Check to be sure the device will work well at reduced battery voltages, as, for example, from partially dead batteries.

Often batteries partially dead, or overworked, develop a high internal resistance, either temporary or permanent. Will your device work under these conditions?

(8) *Safety:* This does not mean the safety of personnel. Of course, high voltages should be generally inaccessible, and certainly well-marked, and other shock danger should be minimized. But this refers to the safety of other equipment. If a resistor burning up will cause two five-dollar transistors to blow out, perhaps you'd be wise to invest in a slightly more hefty resistor. Similarly, if a control device of some sort will cause costly damage if it burns up or ceases to operate, be sure to include some "fail-safe" arrangement to prevent this costly damage. If your device's failing will cause inconvenience unless repaired quickly, perhaps you'd do well to think about ways to bypass it when it is out of service.

Of course, the device itself should be fused, if it operates from the line.

(9) *Switching transients:* Some devices which work very well otherwise are troubled by switching transients. These are caused, in general, by the fact that throwing a switch does not occur instantly; rather there is some time lag between switch positions. Unless care is taken to select shorting or non-shorting switches, and to wire them properly, the mere act of turning the device on or off might be objectionable, or might even cause current surges in the equipment, or arcing of switch contacts. A common example is the "radio-phon" switch on a hi-fi tuner. A shorting switch should be used so that the input to the amplifier is never left open-circuited. A non-shorting type switch causes considerably more noise.

In addition, quite apart from the switching time, charging or discharging capacitors rapidly when switching often induces clicks or noises in the circuit and current surges which can occasionally damage such components as transistors.

(10) *Write it down:* Get information on the device down on paper. When you finish the design, don't trust important details to memory. Your memory is not perfect—a few months or even weeks later you may be a stranger to the equipment. Don't throw your valuable work down the drain. Get all the information down in a form which you or another person will be able to use in operating or repairing the device.

Get it all—whatever is applicable—whether it be schematics, pictorial diagrams, parts placement diagrams, waveforms of various points, current and voltage readings, functions of control knobs and switches, block diagrams, adjustments and alignment procedures, parts lists, specifications for unusual or home-made parts, or operating and service instructions. Often in writing all this down, you will see chances for improvements, unsuspected weaknesses, etc.

If you intend to apply for a patent on some feature of the device, by all means date and sign all pages you write, especially those when you first conceive of the patentable features. If possible, get two people to sign as witnesses to your signature. They don't have to understand the material, they just vouch that you signed on the date specified. Use ink, of course, for all notations.

On "hot" items get a notary public to date and witness your signature. If possible, get the information down in a cloth-bound notebook (not looseleaf) and number and date every page. This sort of evidence is very important in establishing prior invention. Research organizations require their engineers to keep a similar book, dating every page.

(11) *Looks:* It almost goes without saying that the device should be pleasing to the eye. But since much equipment, even commercial gear, is ugly, perhaps it does need saying.

A device should be good looking not merely for the joy of looking at it. Well-formed solder joints, and neat, logical wiring will probably never be seen much, yet it is important to do a neat job. A careful job means fewer mistakes, and the device is easier to troubleshoot if it is neat and well laid out.

Also, neatness is the sign of a good craftsman. In this day of mass production, some people see no point in good craftsmanship, but its value should be obvious—not only to attain a pride of accomplishment, and avoid mistakes, but also to impress other people.

The outside of the device should also be good looking. Don't let your product stick out like a "sore thumb" because you failed to consider this point.

Many of the points covered here are overlooked by circuit designers, especially beginners. But work done to correct the design faults, as outlined in this article, will pay for itself many times over in better and more reliable performance from the device. —50—

March, 1957

RADIO • TELEVISION • INDUSTRIAL ELECTRONICS

THIS professional TRAINING IS THE KIND THAT Really Pays Off!

... and it costs only a fraction of what you might expect to pay!

FIX ANY RADIO OR TV SET EVER MADE...easier...better...faster

Backed by the how-to-do-it methods so clearly explained in this one big 822-page book, you'll be prepared for fast, accurate service on any radio or television receiver ever made.

Radio & Television TROUBLESHOOTING AND REPAIR by Ghirardi & Johnson is far and away the world's most modern, easily understood guide. Step by step, it takes you through each service procedure... from locating troubles with less testing to repairing them promptly by fully-approved professional methods... the kind that enable you to handle tough jobs as slick as you now do the easy ones.

Best of all, the cost is only \$7.50 (or see money-saving combination offer in coupon).

COMPLETE SERVICE TRAINING

For beginners, this giant book is a complete training course. For

experienced servicemen, it is an easy way to "brush up" on specific jobs; to develop better methods and shortcuts and to find fast answers to tough jobs.

Here are just a few of the subjects covered: Components and Their Troubles; Basic Troubleshooting Methods; "Static" and "Dynamic" Testing; Practical Troubleshooting Tips and Ideas; AC/DC, 3-way Portable and Battery Set Troubleshooting Problems; Servicing Communications Receivers; a Complete Guide to Television Service; AM, FM, and TV Realignment Made Easy; Resistor, Capacitor, Inductor and Transformer Problems; Servicing Tuning, Selector and Switching Mechanisms; Loudspeakers; Servicing Recorders and Record-playing Equipment... and dozens more! 417 illustrations. Read TROUBLESHOOTING AND REPAIR for 10 days AT OUR RISK!

LEARN BASIC CIRCUITS FULLY... and watch service "headaches" disappear

It's amazing how much easier and faster you can repair radios, television sets and even industrial electronic equipment when you know all about circuits and what makes each one "tick."

You locate troubles in a jiffy because you know what to look for and where to look.

You make repairs lots faster, better and more profitably!

Actually, there are only a comparatively few BASIC circuits in modern equipment. Radio & Television RECEIVER CIRCUITRY AND OPERATION by Ghirardi and Johnson gives you a complete understanding of these as well as their variations. It teaches you to recognize them... to under-

stand their peculiarities and likely "troubleshooting" and shows how to eliminate useless testing and guesswork in making repairs.

LEARN MORE—LEARN MORE!

Throughout, this 669-page book with its 417 clear illustrations gives you the kind of above-average professional training that fits you for the better, big pay jobs in either servicing or general electronics.

Covers all circuits in modern TV and radio receivers, amplifiers, phono-pickups, record players, etc.

Price only \$6.75... or see money-saving offer in coupon. Examine it 10 days at our risk!

SAVE \$1.25
Make your training library complete! Get both these big books at the low price of only \$13.00 for the two (you save \$1.25).

The books that EXPLAIN SERVICE so you can really understand it!

More radio-TV technicians have trained from Ghirardi books than any others of their kind! Almost 1300 pages and over 800 pictures and diagrams in these two new books explain things so clearly it's next to impossible for you to go wrong. Each book is strictly up-to-the-minute... NOT a re-hash of old, out-moded material.

FREE EXAMINATION...easy terms!

Dept. RN-37, RINEHART & CO., INC.
232 Madison Ave., New York 16, N. Y.

Send books indicated for FREE EXAMINATION. In 10 days, I will either remit price indicated plus postage or return books postpaid and owe you nothing.

Radio & TV TROUBLESHOOTING AND REPAIR (Price \$7.50) Radio & TV CIRCUITRY AND OPERATION (Price \$6.75)

COMBINATION OFFER... Both books only \$13.00 (Regularly price separately \$14.25... you save \$1.25)

(Combination offer is payable at rate of \$4 (plus postage) after 10 days if you decide to keep books, and \$3 a month thereafter until \$13 has been paid.)

Name.....
Address.....
City, Zone, State.....
OUTSIDE U.S.A. \$8.00 for TROUBLESHOOTING & REPAIR; \$7.25 for CIRCUITRY & OPERATION; \$14.00 for both books; Cash with order, but money refunded if you return books in 10 days.

Unusual TV Circuit Troubles



By RICHARD BLITZER

Watch out for the "simple" cases where the symptoms point in one direction, but the fault is elsewhere.

MOST technicians are familiar with the day-in, day-out troubles that can plague television receivers but occasionally some unusual cases come along that prove to be real stumpers. Some of these off-the-beaten-track troubles will be outlined below.

Picture and Sound Not Tracking

When picture and sound come in separately at different settings of the fine tuning control, the trouble is described as "picture and sound not tracking" and the front end or tuner is usually at fault.

A 1951 *Philco* intercarrier receiver came into the shop with the report that it had a good picture but no sound on all channels. By adjusting the fine tuner, however, good sound could be brought in but the picture either weakened or disappeared completely.

After laboriously checking the alignment of the tuner and finding it correct, attention centered elsewhere. The frequency response curve of the entire video i.f. section was next checked and found to be much too narrow. Adjusting the i.f. transformers did not help. Checking the frequency response of the individual i.f. stages showed that the trouble lay in the first stage. An ohmmeter check indicated that an open cathode resistor was causing the trouble.

When this resistor was replaced, the response curve became much broader and the picture and sound came through simultaneously.

Another case of picture and sound not "tracking" was encountered in a *Du Mont* Model RA103, a split-sound receiver using the "Inductuner" type of front end.

Along with this trouble there also existed, on channel 9 only, horizontal

dashed black lines across the screen, without either picture or sound coming through.

After changing the tubes in the tuner and the video i.f. stages, the sound i.f. section came under scrutiny. The first sound i.f. amplifier, which called for a 6AU6 tube, was found to be using a 6AG5 instead. These tubes are usually interchangeable. However, the 6AU6 uses pin 7 only as its cathode connection, and pin 2 only as its suppressor grid connection. The 6AG5 uses pins 2 and 7, tied internally, as connections for both cathode and suppressor. Using a 6AG5 tube in this circuit shorted out the 68-ohm cathode resistor. This apparently detuned the sound i.f. take-off coil which was connected from the first video i.f. stage. This effect was noticeable, as previously described, only on channel 9.

Replacing the 6AG5 first sound i.f. with a 6AU6 tube produced the desired results. Each channel's picture and sound came through simultaneously. The 6AG5 tube was checked later, both in a tube tester and in an operating receiver. The tube checked OK in both cases but, to play it safe, the tube was discarded.

Sound without Raster

Sometimes a symptom shows up in a receiver which, at first, points to a simple solution. After routine checks, however, the fault seems more difficult to locate. An example of such a case was encountered recently at the author's shop. The receiver was a *Zenith* Model 24G26, using a conventional flyback high-voltage power supply. See Fig. 1.

The symptom was the common one of good sound without raster. The high r.f. voltage, as evidenced by drawing a long spark with a screwdriver

blade, was present at the plate cap of the 1B3, the high-voltage rectifier. No high d.c. voltage could be found at the anode connection to the picture tube. Naturally, the 1B3 tube was immediately suspected. Substituting a good tube did not help. Ohmmeter checks were then taken at the tube socket with the set off and the 1B3 tube removed from the chassis. The chassis was still in its cabinet. A reading of about 2 ohms was indicated at the tube socket from pins 2 to 7. See Fig. 1. This showed that the 1B3 filament secondary was not open and that the 2.2 ohm filament voltage dropping resistor seemed to be OK.

An ohmmeter reading from pin 7 of the 1B3 tube socket to the high-voltage anode of the picture tube indicated that the 470,000 ohm resistor was normal. Finally, the 500 μ fd. high-voltage filter capacitor from pin 7 to the chassis read "infinity" on the ohmmeter. This, of course, proved only that this capacitor was not shorted when it was measured. It still could have been the culprit, becoming leaky only when a high voltage appeared across it.

After this operation the chassis was removed from the cabinet and taken to the shop. On the bench it was noted that the filament of the 1B3 tube was not glowing visibly, even when viewed in a dark room. Measuring the a.c. filament voltage from pins 2 to 7 showed only about $\frac{1}{4}$ volt with the tube out of the socket. The same reading was produced with the a.c. voltmeter connected directly across the filament secondary.

The filament secondary voltage should be about 2 volts, produced by a single turn of secondary wire in the high-voltage horizontal output transformer. This 8-inch piece of secondary

wire was then slipped off the transformer and a longer piece substituted in its place, wrapped around with several turns. The voltage now read about 2 volts with the 1B3 out of the socket. Replacing the tube in its socket now produced a glowing filament, high d.c. voltage at the picture tube anode, but a very narrow raster horizontally. The raster was bright enough but not of normally smooth appearance, the sides being uneven and jagged.

At this point, the oscilloscope was employed to check waveform and frequency of the horizontal oscillator and discharge tubes. These turned out to be normal. However, the waveform across the L_1 secondary connected to the horizontal deflection coils was of an undecipherable type. Disconnecting the deflection coils did not alter the waveshape across L_1 .

With some hesitation a new transformer was purchased and installed. The raster and picture came in normally. The explanation apparently was that the L_1 secondary had some shorted or leaky turns which did not seriously affect the high r.f. voltage which was produced at the plate of the 1B3. However, the single turn filament secondary was not getting its normal induced voltage due to L_1 being defective. Incidentally, the defective L_1 and all other transformer windings measured normal using an ohmmeter.

Dim Raster

Trouble in the vertical section of a receiver usually results in either a vertically non-linear picture, foldover, roll, or even lack of picture height. A dim or missing raster would not ordinarily be associated with a deficiency in the vertical circuit, yet that is exactly the trouble the author encountered in the case to be described.

Fig. 2 shows a partial schematic of the receiver, a G-E Model 17T7.

V_2 and V_3 function as the vertical oscillator (a plate-coupled multi-vibrator type), discharge tube, and vertical output stage.

The square wave at the vertical output tube plate is transformer-coupled to the yoke and also fed through capacitor C_1 to the grid of V_1 . This stage functions as a straightforward amplifier, providing vertical blanking. Vertical flyback or retrace occurs during the shaded portion of the square-wave voltage on the schematic. The plate voltage on V_1 decreases at this time, lowering the picture tube's accelerating anode, pin 10, voltage as well. This reduces the conductivity of the cathode-ray tube and prevents the diagonal white lines from being seen during the vertical retrace time.

When the raster was found to be dim, the usual checks were made. The filament looked bright enough and high d.c. voltage on the final anode was OK. The d.c. voltage (bias) between grid and cathode (pins 2 and 11) of the picture tube acted normally with various settings of the brightness control. However, pin 10, the

accelerating anode, measured only +27 volts instead of the +300 volts required.

In Fig. 2, it can be seen that the accelerating anode gets its voltage through R_1 from the boosted "B+" of the damper tube. Measuring this boosted "B+" voltage showed it to be correct, +320 volts. R_1 was then checked and showed up OK on the ohmmeter.

Finally V_1 , the vertical blanking tube, was replaced. The picture now appeared brighter and normal. Checking V_1 showed its grid and cathode to be shorted. This produced zero bias on V_1 allowing it to conduct unusually heavily. A large voltage drop was produced across R_1 , thereby reducing accelerating anode voltage.

Negative Picture

Picture overload, which shows up as a negative-like picture, would not ordinarily be connected with a defect in the horizontal output stage, yet this stage was responsible for just such an occurrence in the following case.

Fig. 3 is a simplified partial schematic of the keyed a.g.c. and horizontal output stages of an *Admiral* receiver. This circuit is typical of many other sets as well.

V_1 , the a.g.c. tube, is "keyed" or "gated" into conduction by two incoming signals: (a) the positive-going horizontal synchronizing pulse portion of the video signal which is applied to the control grid and (b) the positive-going pulse portion of the horizontal deflection signal from the horizontal output transformer, which is applied to the plate of the a.g.c. tube.

When V_1 conducts, its plate current flows through R_1 , making the ungrounded end of R_1 a negative voltage point. This negative voltage is the a.g.c. voltage used as bias by several video i.f. amplifiers and the r.f. amplifier.

C_1 is the screen grid bypass capacitor for the horizontal output tube. When it opens, it allows screen voltage to vary in accordance with the input grid signal instead of remaining constant. This degeneration results in less gain from the horizontal output tube. The slightly reduced horizontal deflection signal apparently does not

Fig. 1. A defective yoke winding unbalanced the h.v. transformer, reduced rectifier filament voltage, and killed h.v.

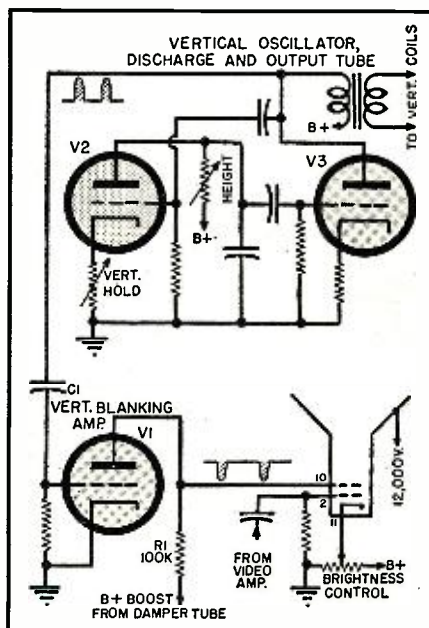
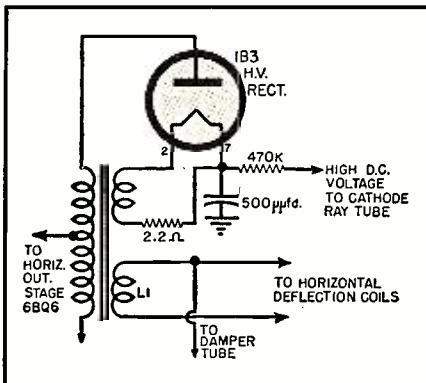

Fig. 2. A vertical circuit fault dimmed the raster. Excessive conduction of the blanking amplifier reduced voltage on the accelerating anode of the picture tube.

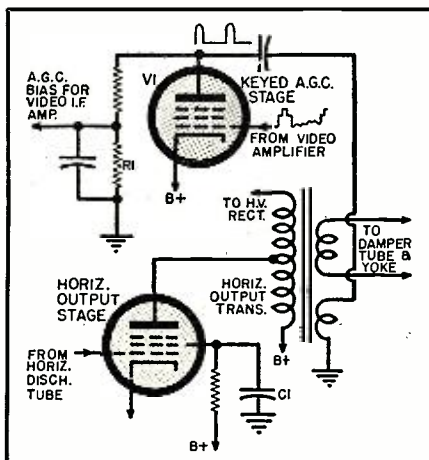

Fig. 3. Trouble in the horizontal amplifier reduced the flyback pulse. Although the raster appeared unaffected, operation of the keyed a.g.c. stage was disturbed.

materially affect the high voltage or the size of the raster. However, the smaller signal cannot "key" off the a.g.c. tube. This results in no negative a.g.c. bias voltage being developed. As a result, the video i.f. and r.f. amplifiers, operating with zero bias, become overloaded and produce distorted and negative-appearing pictures.

In troubleshooting this receiver, the bias on the video i.f. amplifiers was first measured and found to be zero. The a.g.c. stage was checked using a voltmeter and ohmmeter. All components checked good. An oscilloscope was then employed and showed a decreased input pulse at the a.g.c. plate from the horizontal output stage.

Replacing this tube didn't help, but when a new capacitor was shunted across C_1 , the trouble immediately cleared and the picture returned to normal.

LAMPKIN FREQUENCY and FM MODULATION METERS

NOW... on TIME PAYMENT PLAN

Enter the lucrative mobile-radio maintenance field—AT LOW COST!



Price \$220.00
Type 105-B Frequency Meter

Lampkin's new easy-payment plan makes it possible for you to start in mobile-radio maintenance NOW—and the monthly payments for your essential test equipment will be far less than your expected earnings.

You've read how mobile-radio is bursting its seams! NOW — you can start cashing in on this boom... with a low down payment!

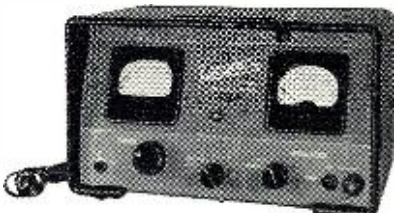

Price \$240.00
Type 205-A Modulation Meter

For free booklet "HOW TO MAKE MONEY IN MOBILE-RADIO MAINTENANCE," and other data—
USE COUPON TODAY

LAMPKIN LABORATORIES, INC.
MFM Division, Bradenton, Florida

At no obligation, please send me free booklet, technical data on Lampkin meters, and time-payment plan details.

Name _____
Address _____
City _____ State _____

LAMPKIN LABORATORIES, INC.
MFM Division
BRADENTON, FLORIDA

F.C.C. LICENSE QUICKLY!

Grantham Training Is Best

Grantham School of Electronics specializes in preparing students to pass FCC examinations. We train you quickly and well. All courses begin with basic fundamentals—NO previous training required. Beginners get 1st class commercial (not amateur) license in 12 weeks!

Here's Proof! Recent graduates, the licensethey got, and how long it took them:

Name	License Weeks
D. Seigler, 216 Dowling, Walterboro, S. C.	1st 10
Tim Marek, P.O. Box 9167, Suitland, Md.	1st 13
W. Reynolds, 328½ Wash. Bl., Venice, Cal.	1st 12
Richard Jones, Station KGHF, Pueblo, Colo.	1st 13
Joe C. Davis, Waynesboro, Miss.	1st 11
W. Mains, 6332 S. Paramount, Rivera, Cal.	1st 12
B. A. Willms, 1401 E. Muriel, Orlando, Fla.	1st 12
J. Murphy, Wesley Hotel, Washington, D. C.	1st 12

Learn by Mail or in Residence

You can train either by correspondence or in residence at either division of Grantham School of Electronics—Hollywood, Calif., or Washington, D.C. Our free booklet, "Opportunities in Electronics," gives details of both types of courses. Send for your free copy today.

(Mail coupon to school nearest you)

Grantham Schools, Desk 76-C

821 19th Street, NW Washington 6, D. C. OR 1505 N. Western Ave. Hollywood 27, Calif.

Please send me your free booklet, telling how I can get my commercial FCC license quickly. I understand there is no obligation and no salesman will call.

NAME _____
ADDRESS _____
CITY _____ STATE _____

BUY DIRECT FROM FACTORY

THE New Transistorized VTVM-VOM KIT

NO AC source required
Has long battery life because of Transistors

2 PRECISION

\$29 KIT
\$49 assembled

Only **\$10** gets you started

Lab & Service Instruments in 1

Combines a transistorized VTVM with a precision VOM (Voltmeter-Ohmmeter-Milliammeter) giving you: (1) additional vital functions... (2) instantaneous checking of VTVM readings... (3) eliminates doubtful results often obtained with a VTVM.

Completely self-contained. No AC power required; no vacuum tubes to go bad. Turn of switch converts to VOM. Double checks readings (VOM against the VTVM). Over \$60 in precision parts in kit, such as 1% Resistors, Shunts, Microammeter, etc. Anyone can assemble in a few hours. Only \$10 gets you started; balance in easy payments. Rush order direct to factory:—

TRANSVISION, INC. • NEW ROCHELLE, N. Y.

Transvision, Inc., New Rochelle, N. Y. RN-3
Enclosed find \$.....; please send..... Transistorized VTVM-VOM kits.

Name _____
Address _____
City _____ Zone _____ State _____

Muntz TV Hints

By R. A. HUNHOLZ

Intermittent drop in 2nd anode supply cleared up.

THE 21" Muntz table TV set, the Model 17B6, was taken to the shop for tuner repairs. The tuner was fixed and the set given an operational check. During this test the high voltage (15.5 kv.) fell to 9 kv. but instantly returned to its former reading.

The customer had complained of an arcing noise so the one-turn filament winding on the flyback transformer for the 1B3 was replaced. A special 25,000-volt wire was used as a replacement on the basis of previous experience which showed this to be a common fault with these receivers.

The set was then returned to the owner but three weeks later, after a period during which the set was not in use due to the owner being on vacation, the customer called again and complained of the arcing noise and no picture. The set was checked in the home and it was found that the high voltage was arcing across the porcelain stand-off insulator mounting the 1B3 socket.

The insulator was cleaned with carbon tet and polished with a clean cloth. The set then apparently returned to normal operation. About a month later the customer reported that after an hour of operation the set would black out for about 5 minutes and then come back for the rest of the evening.

Another report of the set being inoperative turned up the case of the picture and sound OK when the set was first turned on but with the picture darkening and disappearing after a few minutes. Replacement of the 1B3, 6W4, 6BQ6, and 6SN7, one after another, failed to correct the trouble.

The grid of the 6BQ6 was checked for drive and showed up OK. The cathode of the 6W4 was checked for boost voltage and it checked out all right. The high voltage was measured but instead of reading 15.5 kv. the reading was now 5.5 kv. The checks for drive and boost voltage proved that the coupling properties of the flyback were right, that the yoke was good, and that the damper circuit was functioning. The 1B3 did not seem to glow as it should. The 3.9 ohm resistor in series with the one-turn filament winding checked OK. The set was then hauled into the shop.

The leads were unsoldered on the flyback transformer and the flyback tester used. Everything was OK. A v.t.v.m. was then used to take comparative resistance readings and the only variations from the published service data was in the primary. The

RADIO & TELEVISION NEWS

reading was 250 ohms when it should have been 410 ohms.

A new flyback was substituted but there was still no high voltage. Having replaced all units or having checked them out, with the exception of the 1B3 socket and mounting, the search now centered on these components. The glazed porcelain insulator, 1" long by 1/2" in diameter, has a threaded hole in each end. The pressed steel corona ring cup is fastened to one end by means of a machine screw and the 1B3 socket snaps into this cup. The cup is at the high voltage level. The other end of the porcelain mounting fastens to the chassis with a machine screw and is at zero potential.

The v.t.v.m. was set on the megohm scale and a reading taken from the chassis to the top of the mounting insulator. This disclosed a leakage of 15 megohms paralleling the high voltage circuit. Inspection of the parts after removal, in which operation the screw holding the corona ring to the porcelain mounting was backed off, showed water and rust damage and a hairline crack in the porcelain. In light of these disclosures, a logical correlation for the intermittent high voltage and the various time intervals and the amount of water to be evaporated became clear. The condition worsened as the residue became more conductive.

As a permanent solution to the problem a 500 $\mu\mu\text{fd.}$, 20,000 volt ceramic filter capacitor was installed. This unit has both ends threaded, is the same over-all height, provides filtering, and mounts the same as the porcelain insulator. The high voltage was thus restored and the customer is now a happy man. —50—

Under contract to RDC's Rome Air Development Center, the Westinghouse Electric Corp. is operating an over-the-horizon u.h.f. tropospheric scatter transmission system between Verona, N. Y., and Baltimore, Md. The study is in the bands of 900 mc. and 2000 mc. Data resulting from this study will make it possible to determine scatter transmission system performance in terms of signal attenuations, fading limits, and bandwidth capability as well as practical antenna sizes for maximum gain conditions.

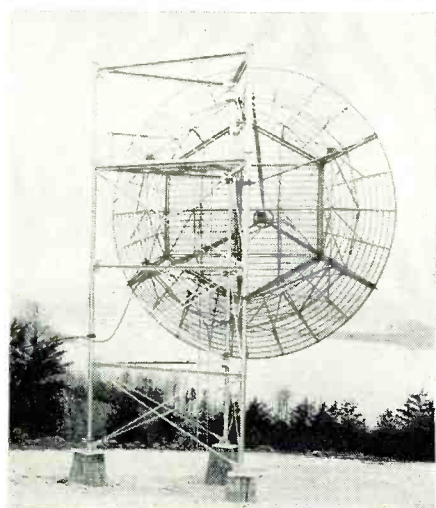

March, 1957

**from carton
to picture
in less time!**

YOU MAKE MORE PROFIT WITH A *Topliner!*

Trade-mark

You're dollars ahead from the very minute you buy a TACO Topliner antenna. Dollar-for-dollar you get more gain and greater customer satisfaction with a Topliner installation because, Topliners are dry-cleaned —clean and easy to handle—Topliners incorporate features to reduce installation time —Topliners are stronger and more rigid.

And most important of all, when the installation is completed you get RESULTS... sharper, brighter pictures that stay bright, thanks to TACO's rugged mechanical construction. Topliners are built to work better and to **STAY WORKING BETTER**—eliminating costly call-backs.

Topliners are available in four models to meet every area requirement. Cat. 2540, 2550, 2560 and 2570. Taco jobbers have complete details on these antennas.

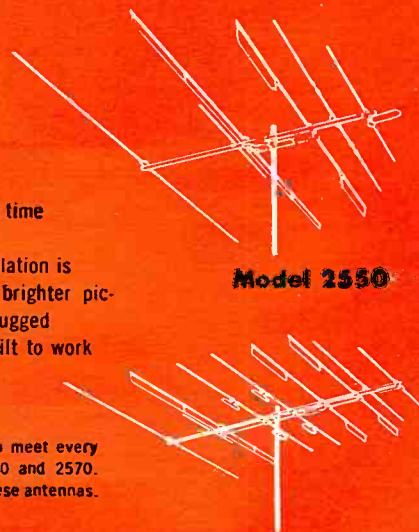

TACO

Model 2570

TECHNICAL APPLIANCE CORPORATION, SHERBURNE, N. Y.
IN CANADA: Hackbusch Electronics, Ltd., Toronto 4, Ont.

TELEVISION

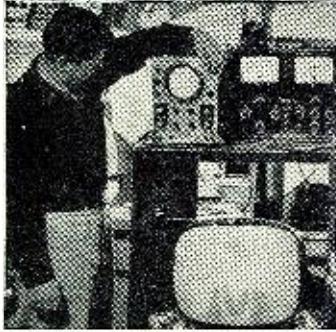

Industry needs Electronic Trained Men Now! Qualify for **BIG PAY JOB**, 9 short months. No other type of training can compare with actual shop practice you get at Healds under expert instructors.

Bachelor of Science Degree, 27 Months

- Electronics Engineering (B.S. Degree)
- Electrical Engineering (B.S. Degree)
- Television Technician (9 Months) Color TV
- Electronics Technician (12 Months)

Heald College ranks **FIRST** West of the Mississippi in "Who's Who in America"

Approved for Veterans

DAY AND EVENING CLASSES

Register Now. Write for Catalog.
(No Obligation.)

Your Name

Address

City

State

AT HEALDS YOU LEARN
BY DOING IN MODERN
ELECTRONICS LABORATORIES

HEALD

ENGINEERING COLLEGE

Van Ness at Post, RTN
San Francisco, Calif.

RADIO & TV NEWS

Watch for Our
New Title
Next Month

A.... Always
B.... Buy
C.... Columbia

- RS-38 HAND CARBON MIKE: \$1.95
 - RS-38 HAND CARBON MIKE: With coiled cord..... \$1.95
 - DM-34 DYNAMOTOR: New, boxed, 12 V. input, 220 V. output @ 80 mills. With filter base..... \$3.95
 - BEDE METER: 0-1 MA. 4" square. Cased in lucite. A beauty! Orig. cost \$18.00. Our clean-out price..... \$7.95
 - CLASSY METAL CABINET: 17 3/4" wide x 12" deep x 11 1/2" high. New, crackle finish. Houses receiver, radio, amp, hi-fi, etc. Self-lock front, open-up back lid. BUY AN EXTRA FOR THE WIFE. Get two (2) for \$5.00..... \$2.95
 - BC-604 TANK TRANSMITTER: 20-27 MC. FM. Good condition. Less dynamotor. Another clean-out special..... \$7.95
 - ARB RECEIVER**
190-9050 Kc. 4-band continuous tuning. Excellent condition..... \$19.95
 - TCS REMOTE CONTROL BOX**
Contains many parts plus JENSEN SPEAKER with a mammoth slug. The speaker makes terrific 25-30 Watt tweeter for hi-fi. It alone is worth \$10.00. Complete unit, new..... \$7.95
 - MBF TRANSCEIVER**
Late model. Ideal 6 and 10 meter set-up. 115 VAC and DC. Good condition. Size 9 1/2 x 10-1/16 x 15-13/16"..... \$22.95
 - COMMAND GEAR—EXCELLENT COND.**
 - BC-453 RECVR. 19-55 MC Q 5'er..... \$12.95
 - BC-454 RECVR. 3-6 MC 80 meters. ONLY..... 4.95
 - BC-455 RECVR. 6-9.1 MC. 40 meters..... 4.95
 - BC-457 XMTR. 4-5.3 MC. Special!..... 2.95
 - BC-458 XMTR. 5-3.7 MC. It's a steal!..... 2.95
 - 4-5.3 MC. XMTR. Brand new, boxed. Only 5-3.7 MC. XMTR. Spanking new! Boxed!..... 4.95
 - BC-456 MODULATOR: Excellent cond. 4.95
 - BC-442 ANTENNA SWITCHING RELAY: with vacuum capacitor. New, low price..... 3.49
 - TRIPLE RECEIVER RACK. With shock mount..... 2.50
 - DOUBLE XMTR. RACK With shock mount..... 2.50
 - ALL PLUGS: For SCR-274N or ARC-3. Ea. 1.00
 - 1625 TUBES: For spares. New, boxed. Ea. TRIPLE RECEIVER CONTROL BOX..... .95
 - BC-450 TRANSMITTER CONTROL BOX. Only..... .95
 - 18 FT. FLEX CABLE TACH SHAFTS. To control receiver remotely. Special..... 1.95
- All orders FOB Los Angeles. 25% deposit required. All items subject to prior sale. MINIMUM ORDER \$3.00.
- OPEN FRIDAY NITE TILL 10 P.M.

Columbia ELECTRONICS
2251 W. WASHINGTON BLVD.
LOS ANGELES 18, CALIFORNIA

CHROME VANADIUM 29 Pc. DRILL SET

Specially made for speed drilling. In sturdy plastic tool roll. Finest alloy steel drills hardened and precision ground to the sharpest, longest lasting cutting edge obtainable; will easily and cleanly bite through hardwoods, plastics, aluminum, iron and the toughest steels. Unconditionally guaranteed for thousands of drillings. Full jobber length. Sizes by 6ths from 1/16 to 1/2". NOW..... \$6.49 ppd.

Also available with Turned Down Shanks to fit all 1/4" drills. In individual pocket roll..... \$8.95 ppd.

60 Pc. Set Wire Gauge CHROME VANADIUM DRILLS

Top quality German import high test Chrome Vanadium Drills designed for speed drilling through toughest steels, woods, plastic, iron and aluminum. Precision ground, long-lasting cutting edges. Guaranteed to give years of satisfaction. A full 60 pc. set. Nos. 1 through 60. A \$14.95 value—NOW ONLY..... \$5.40 plus 35¢ pp. & hdg.

Same set above available with Huet Metal Index container—Only..... \$6.65 plus 35¢ pp. & hdg.

Also Available—20-PC. SET NOS. 61-80 WIRE GAUGE DRILLS Only Finest steel! Tops for precision work in woods, plastic, iron, aluminum, etc. Includes plastic kit with marked pocket for each drill. \$2.50 ppd.

75c ea. for Finest Imported PRECISION PLIERS

- Flat Nose
- Round Nose
- Combination
- One Side Flat—One Side Round
- Diagonal Cutter
- Snipe
- End Cutting

Nippers
FOR JEWELERS, OPTICAL WORKERS, HOBBYISTS, CRAFTSMEN OF ALL KINDS! These superb German instruments are of deep-forged, heat-treated high quality tool steel, fabricated to most exacting specifications. All-over ground and polished to smooth hard surfaces. Smooth working joints with just the right tension. Jaws meet perfectly to safely and securely hold even the most delicate objects in the hard-to-reach corners and angles. Each plier is 4" long and a veritable gem of precision and strength.

75c ea., all 7 for \$5.00 ppd.

Special! PLASTIC ELECTRICAL TAPE
Resists abrasion, water, acids, alkali and corrosion. First quality guaranteed. 3/4" wide, 30 ft. roll, 98c roll—NOW 2 FOR \$1 ppd. 108 ft. roll—reg. \$2.95—NOW \$1.69 ppd.

Send Check or M.O. C.O.D. fee extra.
MONEY BACK GUARANTEE
SCOTT-MITCHELL HOUSE, INC.
DEPT. M-324, 611 BROADWAY, NEW YORK 12, N. Y.

TV Lead-in Serves as S.W. or B.C. Band Antenna

By PAUL FALK

Added unit can also be used for talking circuit in TV antenna installation.

WITH the circuit shown, a TV lead-in can double as antenna for a radio or s.w. converter without a loss of efficiency on TV.

Make L_1 by wrapping 20 turns of #22 wire on a 1/2" form; bring out a loop for center tap X, and continue with 20 turns more. Remove the coil from the form and mount on a piece of fiber 2" x 3" in which suitable mounting holes have been drilled.

C_1 and C_2 should be 20 to 50 μfd . each, but not over 50. They provide the path for v.h.f. and u.h.f. energy to reach the TV set. The inductance of L_1 will tend to block these frequencies from reaching point X, but will permit longer waves to pass; while the capacitors block the longer waves from the TV set. In effect, desired filtering action is being provided for both units.

The addition of C_3 (which can often be achieved simply by twisting together the leads at X and Y for some distance) will act to improve rejection of many types of TVI. Points X and Y are connecting points for the radio unit, with Y going to earth ground.

When installing or re-orienting TV antennas, the use of a second unit identical to the one described, at the other end of the antenna line, enables use of the lead-in as part of the circuit for the sound-powered or battery-operated phones. In the second unit, the capacitor side of the filter will be connected directly to the antenna. Phones are connected between points X and Y at each end. —30—

Filter gets double duty from TV antenna.

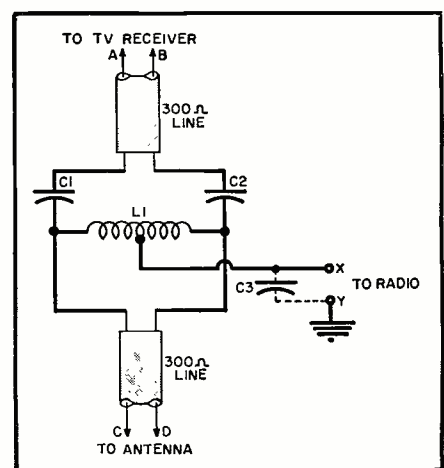

If servicing is one of your interests . . .

you can't afford to miss next month's big



SPECIAL SERVICE FEATURE ISSUE

Designed to meet the needs of the service technician . . . or anyone who wants to keep posted on every development in this vital area . . .

April RADIO & TV NEWS brings you the most complete roundup of service articles, features and news we've ever published.

From cover to cover, the SPECIAL SERVICE FEATURE ISSUE of RADIO & TV NEWS tells you how to broaden the scope of a servicing business . . . how to use your present equipment and "know-how" to expand into allied fields . . . how to take advantage of the daily opportunities that are developing in electronics.

Here are just a few of the many articles you'll want to read:

- ☆ PLANNING A PRACTICAL SERVICE BENCH
- ☆ NEW COLOR TELEVISION TEST EQUIPMENT
- ☆ BOTTLENECKS IN TV SERVICE
- ☆ G-E'S LARGE SCREEN COLOR SETS
- ☆ THE CASE FOR THE CRT TESTER-REACTIVATOR
- ☆ TUBE INVENTORY FOR SERVICE SHOPS
- ☆ QUESTIONS AND ANSWERS ON OSCILLOSCOPES
- ☆ FACING THE PHASE DETECTOR

DON'T MISS THE APRIL SPECIAL SERVICE FEATURE ISSUE ON SALE MARCH 28!



RADIO & TV NEWS

366 MADISON AVENUE • NEW YORK 17, N. Y.

March, 1957

123

**the plier you'll reach for
9 times
out of 10***

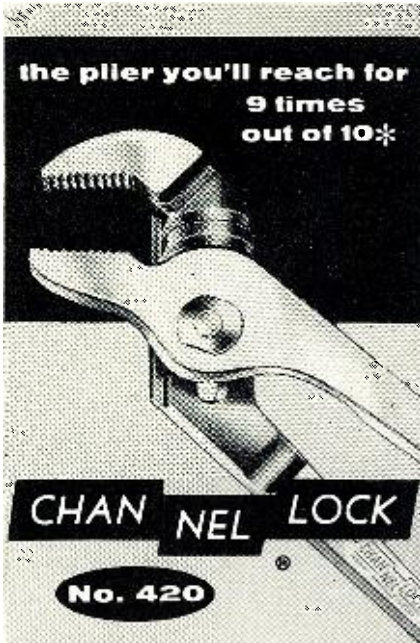

CHAN NEL LOCK
No. 420

***because no other
plier does so many
jobs so well**

**GRIPS LIKE
A PIPE
WRENCH**

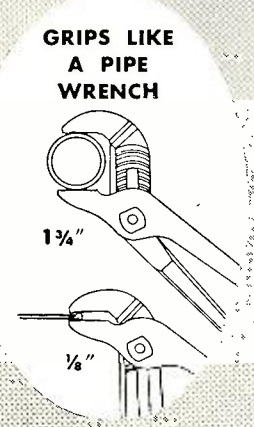

1 1/4"
1/2"

Mechanics tell us that our Channellock No. 420 is the handiest plier of them all... the plier they reach for more often than any other. They like its all 'round usefulness... its pipe-wrench grip... its big jaw-opening... its streamlined design for hard-to-get-at jobs. And you'll like Channellock for the same reasons. Ask your hardware man for a Channellock 420.

BE SURE IT'S A GENUINE CHANNELLOCK



CHAMPION DEPARTMENT TOOL CO. MEADVILLE, PA.

Mac's Service Shop

(Continued from page 70)

owner of a Model T was almost forced into becoming something of an automobile mechanic; so an amateur today is usually well-versed on what can be done to reduce TVI. In his highly specialized magazines, he has read many articles based on actual case histories of the solution of television interference problems."

"I suppose actual work on the receiver falls to the lot of the service technician."

"That's right. The smart amateur will not touch the TV set, for he knows that if anything happens to that set for the next five years after he did touch it, he will get the blame. He always suggests that only a trained technician do anything to the receiver."

"Just what can a technician do?"

"First he can see that the set is in first-class operating condition and that the antenna is delivering the best possible signal to it. The stronger the received signal, the less likelihood there is that the amateur station will cause interference. Inefficient antennas or antennas that are too low, worn out or broken lead lines, corroded lightning arresters or antenna terminals, sets with weak tubes, sets out of alignment, sets with loose shields—these are but a few of the troubles the technician can correct in a routine check. In many cases, the installation of a simple, inexpensive high-pass filter in the antenna lead will clean up the trouble—especially if it is coming from fundamental overload of the first stages of the TV set. This filter passes the TV signals with very little attenuation, but it presents a high impedance to the passage of any signal below forty megacycles or so. When the interfering signal is found to be entering the set *via* the power line, extra line filtering in the set may help."

"How about the ham? What can he do?"

"He can make sure his transmitter is tuned and loaded and driven so as to produce the minimum harmonic radiation consistent with rated output. The transmitter should be housed in a cabinet that is r.f. proof, and all leads coming out of it should be choked and bypassed. A good ground should be connected to the transmitter. Ordinarily a ground lead as short as possible is best, but on the higher frequencies a lead that is an electrical half-wavelength long or a multiple of this length may work out better. Several grounds with different lengths of lead to them may be required for operation on different bands."

"The amateur should see to it that his antenna and feedline are matched so as to keep the standing waves on the feedline to a minimum. Where practical, the use of a shielded feed-

line is a good idea. The transmitting antenna should be as far as possible from TV antennas and power lines. It may be necessary for the ham to install a low-pass filter in the output of his transmitter. This filter passes the transmitter signal with very little attenuation, but it reduces all harmonics falling above forty megacycles or so by a figure of 75 to 100 db."

"You said something awhile ago that made me think a ham transmitter could be absolutely 'clean' and yet produce TVI. How could that possibly be?"

"It happens when the signal from the transmitter encounters some sort of natural rectifier. Such a 'non-linear system,' as this rectifier is called, produces harmonics in the same way that clipping the peaks of a sine wave produces harmonics. A signal that in itself would produce no interference at all will produce very vicious harmonics in the vicinity of such a 'non-linear' system."

"What would constitute such a system?"

"Darned near anything in which an oxide film separates two pieces of metal. Corroded TV antennas or lightning arresters, poor joints in BX cable or house plumbing, metal fences, telephone installations, clothes lines, thermostats, crystal receivers, gutters and roof drains, air ducts—just anything!"

"I'm feeling sorrier for you hams by the minute!" Mac exclaimed. "You've convinced me you fellows get a lot of lumps you don't have coming."

"Check! And before I quit sounding off and get to work, I'd like to make just one other point: it seems to me manufacturers of ham transmitters could do still more to insure their products provide an absolute minimum of TVI. 'TVI suppressed' is too broad a term and really means little. What the ham would like to know is whether or not that transmitter is clean enough not to cause trouble in the absence of any non-linear systems. In other words, he should like to see some published claims on the actual harmonic output measured in the TV frequencies when the transmitter is working into a typical well-designed antenna. I'm convinced that the transmitter manufacturer who concentrates on this problem and produces a transmitter that the buyer can be *sure* will not cause trouble will do right well with the hams. They are sick and tired of trying to de-TV a transmitter after it has been built. It's much, much easier to build in TVI-preventing measures than it is to install them after the transmitter has been wired. I'd just like for each manufacturer to ask himself: 'Have I done everything in the design of this transmitter to insure that it will be as free of TVI as the state of the art permits?' If he can answer that question in the affirmative, the hams are going to beat a path to his door."

-30-

Public Relations for Service

(Continued from page 58)

businesses whose members are under oath to operate their businesses under the provisions of a strict code of ethics. How many associations used it? Very few.

A month after the FTC release, the press services carried another story on TV service which credited the National Better Business Bureau with the statement that the average cost for putting a man in a home to service a TV set is close to five dollars. The news story pointed out that, since it cost five dollars to make a TV service call, shops that advertised service for as little as two dollars per call had to make up the difference in hidden charges for parts or tubes.

This exposé of low service charges advertising as "bait" to hook suckers was carried by most of the metropolitan newspapers. It, too, provided service associations—and individual service dealers—with an exceptionally good opportunity for effective local publicity. Unfortunately, few associations took advantage of it.

Better public relations and public acceptance is easily the major need of the independent service industry. The day-to-day punishment that home service technicians absorb from distracted and unreasonable set owners has driven many good technicians out of the service field into other phases of electronic activity. In the main, public antipathy toward adequate TV labor charges is due to ignorance about the complexities of TV service and of the costs involved in providing honest, competent work.

Another excellent program that had possibilities for use as the basis for developing better customer relations was the "Dagnet" TV program on service gyps that was aired about two years ago. This program clearly showed the relationship of "bait" advertising to crooked service dealings. It pointed out the fact that cheap service actually can be costly.

A number of TV service associations used a tie-in with the "Dagnet" program. They bought spot announcements immediately following the telecast. All reported excellent results from this one-time shot. However, none of them followed up with promotional material to keep the facts alive in the public's mind.

Recently another article with good potential possibilities for improving service dealer-public relations appeared in a widely read national consumer magazine. This is an article titled "How to Get *Honest* TV Service," which ran in the January 1957 issue of *Redbook* magazine.

The article is based on an exhaustive study of service practices in all parts of the country made by the author, Robert Gorman. He diligently sought out information on the numerous ways larcenous technicians operate. He also

truly UNIVERSAL *

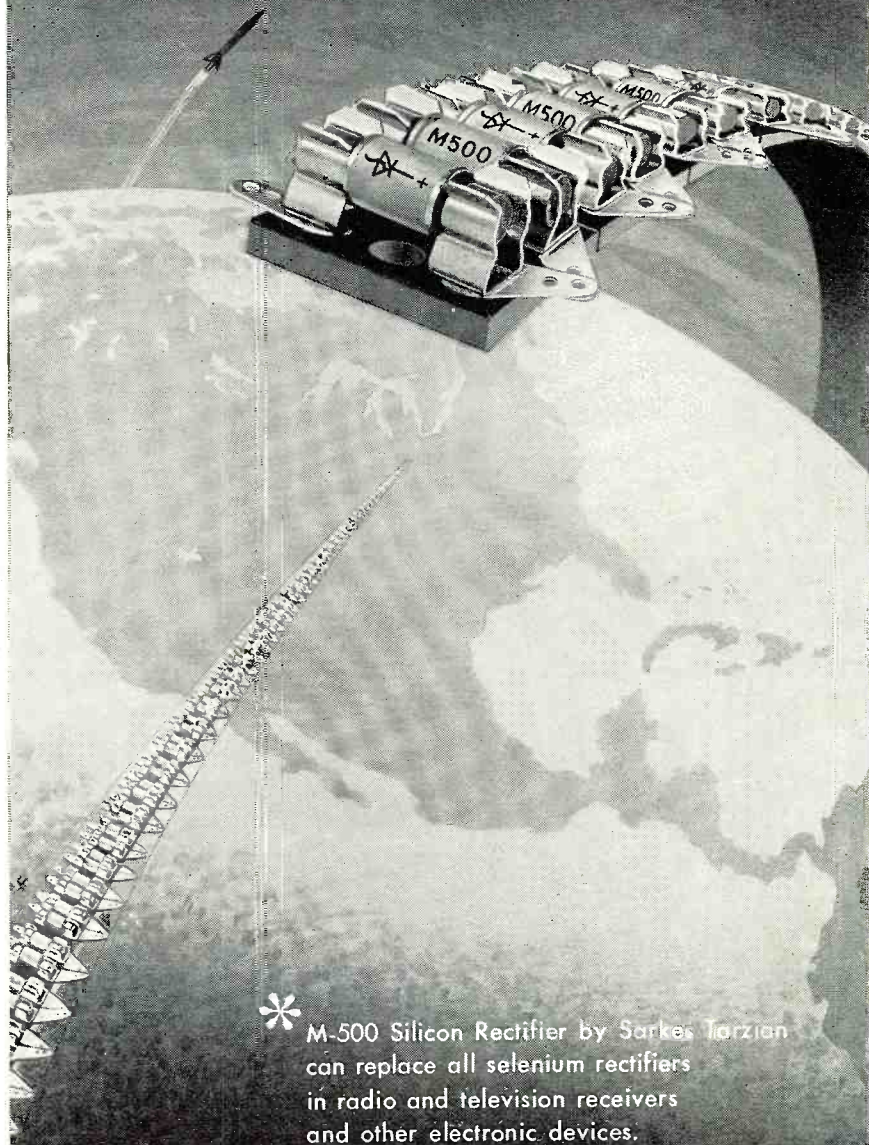

* M-500 Silicon Rectifier by Sarkes Tarzian can replace all selenium rectifiers in radio and television receivers and other electronic devices.

Sarkes
Tarzian INC. RECTIFIER DIVISION

415 N. COLLEGE AVE., BLOOMINGTON, INDIANA

In Canada: 700 Weston Rd., Toronto 9, Tel. Rogers 2-7535 • Export: Ad Auriema, Inc., New York City

REPEATING MESSAGE TAPE RECORDER

MANUFACTURED BY THE LARGEST
ELECTRONICS COMPANY IN U. S.



Features:

- Steel carrying case (can be wall mounted)
- 115 Volts—60 Cycle • Playback and record head
- Tape Speed 3¾ I.P.S.
- 3 Tube Amplifier, plus 2 selenium rectifiers
- MAXIMUM MAGAZINE CAPACITY
Up to 2¼ Minutes Normal Repeat
5 Minutes using ½ Mill tape
- CAPSTAN MECHANISM
Relay Actuated
Readily adapted for multiple phone take-off
Automatic shut-off after each cycle or continuous
(as desired)
- Use any standard speaker suitable (speaker not furnished)

Suggested Uses:

For sales promotion in super-markets, department stores, etc. Useful for demonstrations at conventions, railroad station and bus announcements, or any other form of repetitive advertising.

ORIGINALLY MADE TO SELL FOR
\$180.00

\$49⁵⁰

YOUR COST
ALL BRAND NEW IN
ORIGINAL CARTONS
RECORDING
ADAPTER..... **\$9.95**

Please Note:

If you wish, you may record on any standard 3¾ I.P.S. tape recorder and play back through this unit.

CRYSTAL
MICROPHONE..... **\$5.95**

QUANTITY
OF UNITS
AVAIL-
ABLE
WRITE FOR
QUANTITY
PRICES

WARREN INDUSTRIAL CO., 56 Warren St., New York 7, N. Y. Digby 9-3164

PORTABLE VHF RECEIVER

HEAR PLANES IN FLIGHT,
CONTROL TOWERS,
WEATHER and
EMERGENCY BROADCASTS

PLUGS INTO ANY WALL SOCKET
200 MILE RECEPTION
WITH BUILT-IN ANTENNA

AIR-O-EAR®

(Registered in U.S., Canada and 19 major countries)

SOLD THROUGHOUT THE WORLD
DIRECT FROM MANUFACTURER
Comes complete, ready-to-operate.

30-DAY BILLING

with Purchase Order or
Company letterhead. C.O.D.'s
accepted with no deposit re-
quired. 10-day return privi-
lege if desired.

\$79⁹⁵

CHECK THESE SUPERIOR FEATURES!

BUILT-IN ANTENNA—
PLUGS INTO ANY WALL SOCKET. Operates anywhere
... no installation required.

HEADSET JACK

on control panel; includes automatic speaker cut-out.

AUXILIARY SPEAKER JACK

for plug-in of remote speaker lead.

ADAPTS TO AUTO OR PLANE

with conversion kit (extra). Just unplug for home use.

NOISE-SQUELCH CONTROL

adjustable; completely eliminates static and interference.
Dead silence is maintained except during actual broad-
casts.

24 HOUR CRYSTAL-LIKE STABILITY

highest stability and sensitivity produced by exclusive
coaxial tuning.

STRONG SUPERHETERODYNE CIRCUIT

RF stage, oscillator, mixer, 2 IF amplifiers, audio amp-
lifier, noise-limiting detector, power amplifiers, Noise-
Squelch DC amplifier, Diode Clipper, 2 separate selen-
ium rectifier power supplies, 3-stage automatic volume
control, 6 inch heavy duty oval speaker, PLUGS INTO
ANY WALL SOCKET—115 v. AC, 35 watts (export
shipments furnished with 220 v. 50 or 60 cycles on re-
quest), compact ebony case, black crackle control panel
with white dial calibrations, 7½" x 5" x 4½"; weight
5 lbs., shipped hermetically sealed in plastic with shock-
proof carton.

FLIGHT INFORMATION MANUAL

Orders with payment enclosed will be shipped postpaid
and receive free copy of "Flight Information Manual"
—110 pages of essential information on flight pro-
cedure, 30-day billing with Purchase Order or Company
letterhead. C.O.D.'s accepted with no deposit required.
10-day return privilege if desired.



ADAPTS TO AUTO OR PLANE

Model 710-WN (108 to 130 MC
General Aviation)\$79.95
Model 710-YN (118 to 140 MC
Industrial\$79.95
Conversion Kit (6 or 12-volt)
complete with Whip Antenna \$47.50

AIR-O-EAR IS THE WORLD'S LARGEST

Thousands of AIR-O-EARS ARE USED
THROUGHOUT THE WORLD. Outnum-
ber all others combined. Some of our
leading purchasers are: AMERICAN AIR-
LINES, NORTHEAST AIRLINES,
TRANSOCEAN AIRLINES, STANDARD
OIL COMPANY, ALAMO AIRWAYS,
CHAMPION SPARK PLUG CO., NORTH-
ERN CONSOLIDATED AIRLINES, BELL
AIRCRAFT, U. S. PLYWOOD CORP.,
FLYING TIGER AIRLINES.

SOLD THROUGHOUT THE WORLD:

PARIS — Cie. Francaise d'Expansion
Commerciale

LONDON — F. U. (London) Ltd.
Albermarle St.

BERLIN — Walter Strunck,
Berlin S.W. 68

ROTTERDAM — Unavia,
Groothandelsgebouw

BUENOS AIRES — La Parafinadora,
Argentina

SANTIAGO — Alberto Gonyalez Vidal
& Co., Ltda.

SAO PAULO — Jose Uranga,
Rua Paula Souza 1/25

BOLIVIA — Teodoro Pepper,
O.O. Box 671, La Paz

EXPORT AGENT: Albert D. Denis & Co.,
354 S. Spring St.,
Los Angeles 13, Calif.

DEALERS & DISTRIBUTORS
INQUIRE

NOVA-TECH, INC.

1721 Sepulveda Blvd., Manhattan
Beach, Calif., Cable Address: NTEC

gathered information on what service associations are doing in their efforts to eliminate the crooks and the incompetents from the television service field.

Thousands of set owners will read this article. They will be impressed with the wide variety of ways that dishonest service technicians can cheat them in making TV repairs. They will be inclined to be suspicious of any new technician they may have to call to fix their sets.

The article advises set owners to check on the reputation of the service technician before calling him to fix a TV receiver. It also brings out the fact that service associations are deeply concerned over the depredations of chiselers and crooks in the service business.

Practically all service associations require that their members agree to operate their businesses on the basis of a code of ethics prescribed in the by-laws of the organization. Many associations guarantee the work of their members. The very fact that a service dealer is a member of an association is a good criterion of the stability of his business and of his desire to rid the industry of crooks and incompetents.

Since the *Redbook* article lays the facts on the table about TV technicians who operate with larceny in their hearts, it provides service associations with a splendid publicity base for promoting the work of their members.

No matter how it is accomplished, the obligation to capitalize favorable national publicity that appears in newspapers and magazines rests entirely on the shoulders of legitimate service dealers either individually or collectively through their associations. The national publicity is the tool for improving customer relations. The way it is used locally by dealers will determine the extent of its effectiveness.

ARMSTRONG MEDAL AWARDED

MELVILLE EASTHAM, founder of General Radio Company of Cambridge, Massachusetts received the Armstrong Medal of The Radio Club of America at the group's 47th Anniversary Banquet held recently in New York.

The award was made "in recognition of his outstanding contributions to the art of precision measurements in the radio and electronic field." The citation also read:

"For fifty years a design engineer, Mr. Eastham's effort made available to many workers in the electronic art reliable test equipment of a standardized nature which previously did not exist or had to be specially assembled as a laboratory setup.

"Besides his many technical contributions, Mr. Eastham was a leader in recognizing the importance of good employee relations, and assisted and encouraged his associates in continuing their technical education and in making contributions to technical literature. His thorough, practical approach to design problems and his enlightened management practices should be an inspiration to younger men."

Mr. Eastham now holds the title of Honorary Pres. of General Radio.



BUILD THE BEST—

get the most for your money in ALLIED'S own

knight-kits!

THE FINEST ELECTRONIC EQUIPMENT IN MONEY-SAVING KIT FORM

LOWEST COST

Our huge buying power means biggest savings for you. You do the easy assembly and your finished instrument is equal in performance and appearance to equipment selling for several times the low KNIGHT-KIT price.

LATEST DESIGN

Months of research, development and field-testing go into each KNIGHT-KIT to bring you proved, advanced design. To assure top performance, premium quality parts are supplied in each kit. KNIGHT-KITS are guaranteed to meet published specifications, OR YOUR MONEY BACK.

EASIEST TO ASSEMBLE

All chassis and panels are punched; all parts are clearly marked; even the resistors are mounted on cards, and keyed for easy identification. Each instruction manual is a marvel of "Step-and-Chek" clarity. You get professional results even without experience.

MONEY-BACK GUARANTEE: KNIGHT-KITS FULLY MEET PUBLISHED SPECIFICATIONS, OR WE REFUND YOUR MONEY.



**FEATURING PHANTASTRON
LINEAR SWEEP CIRCUIT**

knight-kit LOW-COST GENERAL-PURPOSE 5" OSCILLOSCOPE KIT

Feature for Feature the World's Best Oscilloscope Value

Model F-146

\$49⁵⁰

This new oscilloscope delivers performance equal to wired units costing several times more and defies comparison with any other 'scope kit at anywhere near its price. It's the ideal choice for radio and TV servicing, audio work and hundreds of other applications—meets 90% of all 'scope requirements. Here are some of the features that make this kit a standout in its class: *Phantastron Sweep Circuit*—versions of this circuit are used in \$1,000 'scopes; provides high linearity of sweep from 15 to 150,000 cps. *Regulated Calibration Voltage*—fully regulated square wave calibrating voltage is injected into signal circuit by spring return switch. *25 Millivolts Per Inch Sensitivity*—three times the sensitivity of other 'scope kits in its price class. *Retrace Blanking*—found only in high-priced 'scopes. *Vertical Amplifier*—frequency response $\pm 3\text{db}$ from 3 cps to 1.5 mc ($\pm 6\text{db}$ to 2.5 mc). Input controls are frequency-compensated. Rise time, .25 micro-seconds. Impedance, 3.3 meg. and 45 mmfd. Includes positive and negative internal sync. Outstanding construction features: CRT protected by heavy rubber ring; sturdy steel case with disappearing handle. For easy assembly: pre-cut color-coded wire; resistors carded and keyed to match instructions; printed circuit; laced wiring harness; "Step-and-Chek" construction manual with wall-size picture diagrams. Supplied with all tubes including CRT, all parts, graph screen, wire, solder. Size, $9\frac{1}{4} \times 13\frac{3}{4} \times 17\frac{3}{4}$ ". Shpg. wt., 26 lbs.

Model F-146. Complete 5" Oscilloscope Kit. Net only **\$49.50**
 F-148. RF Demodulator Probe Kit. Net **\$3.45**
 F-147. Low Capacity Probe Kit. Net **\$3.45**



Model F-123

\$44⁷⁵

knight-kit TV-FM SWEEP GENERATOR KIT

Guaranteed Linearity • Fool-proof Calibration • Wide-Range • Electronic Blanking

All-new; precision-designed for lab use, TV and FM servicing, production line testing. Covers 300 kc to 250 mc continuous on 4 bands (all fundamentals). Center frequencies of VHF TV channels appear on scales. Exclusive KNIGHT-KIT sweep circuit assures perfect linearity—RF sweep output in excess of 0.15 volts, flat within 1 db, is available on all bands. Sweep width continuously variable, 0-13 mc. Dual crystal marker oscillator and input for variable marker (RF Signal Generator on next page is ideal). Phase control provides blanking shift, 0 to 180°. Step-type and continuous output controls; separate marker amplitude control. Filter connected to 0-50 mc output jack provides 20 db attenuation of frequencies above 50 mc to assure pure, fundamental output. Sweep voltage for 'scopes on front panel. Professional-looking blue-finish steel case with gray panel. Has "disappearing" handle. $8\frac{1}{2} \times 12 \times 7\frac{1}{2}$ ". With all parts, tubes, test cable, solder and multi-color pre-cut wire. Less crystal. Shpg. wt., 13 $\frac{1}{2}$ lbs.

Model F-123. TV-FM Sweep Generator Kit. Net only **\$44.75**
 P-286. 4.5 mc Crystal (.005%). Net **\$4.80**
 P-143. 5.0 mc Crystal (.02%). Net **\$3.95**
 P-145. 10.7 mc Crystal (.02%). Net **\$3.95**

EASY PAYMENT TERMS

If your total KNIGHT-KIT order is over \$45, take advantage of our liberal Time Payment Plan—only 10% down. Write for application form today.

ALL PRICES NET F.O.B. CHICAGO

SEE FOLLOWING PAGES >

order from **ALLIED RADIO** 100 N. WESTERN AVE., CHICAGO 80, ILL.

ALLIED'S own knight-kits... better by far



knight-kit 5" ALL-PURPOSE WIDE-BAND OSCILLOSCOPE KIT

2 Printed Circuit Boards • 5 Mc Width for Color TV

Model F-144

\$69⁰⁰

Wide-band, 5" Oscilloscope; equals or betters the performance of commercially-wired 'scopes costing several times the price. Two printed circuit boards and laced wiring harness assure wiring accuracy and reduce assembly time. Ideal for lab use, color TV servicing and high frequency applications. Provides unusually wide sweep range—from 15 to 600,000 cps. Locks in at frequencies as high as 9 mc. Vertical response, 5 cycles to 5 mc. Response, down only 1 db at 3.58 mc color burst frequency; down only 3 db at 5 mc. High vertical sensitivity of 25 mv/inch. Input capacity 20 mmf and 3.5 megs. Outstanding features: cathode-follower vertical and horizontal inputs; 2nd anode provides 1400 volts high-intensity trace; push-pull vertical and horizontal amplifiers; positive and negative locking; faithful square wave response; frequency-compensated attenuator; Z-axis input for intensity modulation; one volt P-P calibrating voltage; astigmatism control; blanking circuit to eliminate retrace lines; DC positioning control. Complete with CRT, all tubes and parts. Handsome, professional, blue-finished steel case with "disappearing" handles. 14½ x 9½ x 16". Shpg. wt., 40 lbs.

Model F-144. Wide-Band 5" Oscilloscope Kit. Net only... **\$69.00**
 F-148. Demodulator Probe. Net... **\$3.45** F-147. Low Capacity Probe. 12 mmf. Net... **\$3.45**



NEW knight-kit VOLTAGE CALIBRATOR KIT

Model **\$12⁷⁵**
 F-136

Permits the use of any scope as a precision peak-to-peak AC voltmeter. Provides a true square-wave voltage on scope screen. Range switch and calibrated potentiometer permit selecting any voltage between .01 and 100 volts, in 4 ranges. Fifth position of switch feeds external signal to scope for comparison. Constant output on line volt. variation from 80-135 v. ±6% on all ranges. Shunt capacitance only 15 mmf. Use any 20,000 ohms/volt VOM or a VTVM for initial calibration. Direct coupling of output provides ground reference for DC scopes. Portable case, 7¼ x 5¼ x 4¾". Ready to build. Shpg. wt., 5 lbs.

Model F-136. Voltage Calibrator Kit. Net... **\$12.75**



knight-kit LOW COST RF SIGNAL GENERATOR KIT

Model F-145 Build this wide-range extremely stable RF signal generator and save two-thirds the cost of a comparable

wired instrument. Ideal for alignment of RF and IF stages in radio and TV sets, and for troubleshooting audio equipment. Delivers output on fundamentals from 160 kc all the way out to 110 mc; useful harmonics to 220 mc. Has built-in 400-cycle sine-wave audio oscillator for modulating RF; audio is also available externally. Features high-stability Colpitts circuit with precision-wound coils—no calibration necessary. Has input for external modulator. Maximum audio output, 10 volts. RF output, over 100,000 micro-volts. Step and continuous-type output attenuators. With all parts, tubes, wire and solder. Portable case, 7 x 10 x 5". Shpg. wt., 10 lbs.

Model F-145. RF Signal Generator Kit. Net only... **\$19.75**



Model F-135
\$26⁵⁰

knight-kit VISUAL-AURAL SIGNAL TRACER KIT

A remarkable value in an instrument which permits visual and aural signal tracing of RF, IF, video and audio circuits—has highest gain in its price class. Traces the signal from the antenna to the speaker. Reproduces signal at plate or grid connection of any stage. Identifies and isolates "dead" stages. Features: usable gain of 91,000; "magic eye" with calibrated attenuators for signal presence indication and stage-by-stage gain measurements; built-in 4" PM speaker; single probe with plug-in head gives instant choice of RF or audio tracing. Provides noise test; built-in watt meter calibrated from 25 to 1000 watts; provision for external scope or VTVM. Blue-finish steel case. Shpg. wt., 13 lbs.

Model F-135. Signal Tracer Kit. Net only... **\$26.50**



Model F-129
\$37⁹⁵

NEW knight-kit 6-12 VOLT BATTERY ELIMINATOR KIT

A valuable new unit for servicing auto radios, mobile gear, etc. Delivers continuously variable filtered DC output from 0 to 15 volts. Provides DC output at 0-8 volts or 0-15 volts. Continuous current rating: 12.5 amps at 6 volts, 10 amps at 12 volts. Can also be used as battery charger. Oversize rectifiers and transformer for better regulation and long life. Two meters provide simultaneous current and voltage readings; ranges: 0-15 volts DC; 0-20 amps DC. Doubly protected: fused primary and automatic-reset overload relay for secondary. Heavy-duty binding posts. Blue-finish steel case with "disappearing" handle. With all parts, solder and pre-cut wire. 9 x 12¼ x 7¼". Shpg. wt., 20 lbs.

Model F-129. Power Supply Kit. Net only... **\$37.95**



knight-kit AUDIO GENERATOR KIT

Model F-137 An ideal audio frequency source for checking audio circuits and speaker response. Covers: 20

cps to 1 mc in 5 ranges. Output voltage: 10 volts into 600 ohms impedance. Offers the flat response of a lab standard—±1 db to 1 meg. Generator imp., 600 ohms. Less than .25% distortion from 100 cps through the audible range; less than .5% when driving 600 ohm load at maximum output. Cont. var. step-attenuated output. 17 lbs.

Model F-137. Audio Generator Kit. Net only... **\$37.50**

knight-kit RESISTANCE SUBSTITUTION BOX KIT

Model F-139 Simplifies determination of resistor values needed in a circuit. 36 standard 1 watt resistance values between 15 ohms and 10 megohms with an accuracy of 10%. 18-position switch; also slide switch for multiplying values by 1000. Extra switch wafer serves as tiepoints, eliminating buss bar. 5 x 3 x 2". Complete with test leads and clips. 2 lbs.

Model F-139. Resis. Sub. Box Kit. Net... **\$5.95**

knight-kit CAPACITANCE SUBSTITUTION BOX KIT

Model F-138 Makes it easy to find capacitor values needed in a circuit. Provides 18 standard capacitor values from .0001 mfd. to .22 mfd., ±20%. Values are 600 volts, except .15 and .22 which are 400 volt. 18-position switch selects all values quickly and easily. In bakelite case, 5 x 3 x 2". Complete with all parts, test leads and clips. 2 lbs.

Model F-138. Cap. Sub. Box Kit. Net... **\$5.95**

QUALITY ELECTRONIC TEST EQUIPMENT IN MONEY-SAVING KIT FORM

... easiest to build... you get more... YOU SAVE MORE



4 1/2" Meter

Model F-128 \$16⁹⁵

**knight-kit
1000 OHMS/VOLT VOM KIT**

Exceptional accuracy and versatility at amazing low cost. Ideal for service shop, lab and Amateur use. Uses 4 1/2" meter (400 microamp movement) with separate scales for AC voltage and current, DC voltage and current, decibels and resistance. 38 ranges include: AC, DC and output volts, 0-1-5-10-50-100-500-5000 (1000 ohms/volt sensitivity); Resistance, 0-1000-100,000 ohms and 0-1 meg.; Current, AC or DC, 0-1-10-100 ma and 0-1 amps; Decibels, -20 to +69 in 6 ranges. Uses 1% precision resistors. 3-position function switch and 12-position range switch. Complete kit with bakelite case, (6 3/4 x 5 1/4 x 3 3/4"), battery, pre-cut wire, solder and test leads. Shpg. wt., 2 1/2 lbs.

Model F-128. 1,000 ohms/volt VOM Kit. Net only \$16.95



Model F-140 \$29⁵⁰

**knight-kit
20,000 OHMS/VOLT VOM KIT**

Outstanding quality and performance at extremely low cost. Features 32 ranges; full vision 4 1/2" meter; accuracy ±2% of full scale; 50 microampere sensitivity for 20,000 ohms/volt input resistance on DC; front panel "zero adjust" Single switch selects function and range. Range: AC, DC and output volts, 0-2.5, 10-50-250-1000-5000; Resistance, 0-2000-200,000 ohms and 0-20 meg.; DC ma, 0-1-10-100; DC amps, 0-1-10; Decibels, -30 to +63 in 6 ranges. Uses precision 1% multipliers. Moisture-resistant film-type resistors. Complete kit with bakelite case (6 3/4 x 5 1/4 x 3 3/4"), batteries, pre-cut wire, solder and test leads. Shpg. wt., 5 lbs.

Model F-140. 20,000 ohms/volt VOM Kit. Net only \$29.50

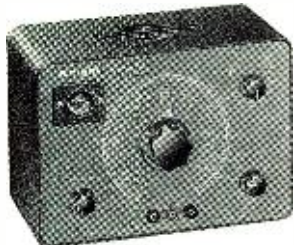

knight-kit RESISTOR-CAPACITOR TESTER KIT

Model F-124 Measures capacitance and resistance by accurate bridge method; checks for opens and shorts in paper, mica and ceramic capacitors; shows power factor of electrolytics. Large dial shows capacitance and

resistance at a glance; balanced-bridge circuit with "magic eye" null indicator measures power factor from 0-50%. Tests capacitors with rated voltages applied. 5 test voltages: 50, 150, 250, 350, 450. Capacity ranges: 10 mmf to 1000 mfd in 5 ranges. Resistance ranges: 100 to 50,000 ohms and 10,000 ohms to 5 megs. Accuracy, ±10%. Automatic discharge feature prevents after-test shock. Blue-finished steel case, 5 x 3 x 2". With tubes and all parts. Shpg. wt., 8 lbs.

Model F-124. Resistor-Capacitor Tester Kit. Net only \$19.50



NEW knight-kit TRANSISTOR & DIODE CHECKER KIT

Model F-149 \$8⁵⁰ Checks leakage-to-gain ratio and noise level of all junction, point contact and barrier transistors. Also checks diodes, forward and reverse current conduction of selenium rectifiers; useful for continuity and short checks. Easy-to-read meter. Features: spring-return leakage gain switch; calibration control; separate sockets for PNP and NPN transistors. Headphones or signal tracer may be used with checker for noise measurements. Case, 5 x 3 x 2". With 22 1/2 volt battery. 2 1/2 lbs.

Model F-149. Transistor Checker Kit. Net. \$8.50

EASY PAYMENT TERMS: If your total KNIGHT-KIT order is over \$45, take advantage of our liberal Time Payment Plan —only 10% down. Write for application blank.

ALL PRICES NET F.O.B. CHICAGO



knight-kit VTVM KIT with Printed Circuit Board

Model F-125 An extremely stable, and highly accurate VTVM. Greatly simplified wiring—entire chassis is a printed circuit board. Maximum convenience in arrangement of scales; 3X AC and DC scale design permits utilization of best portion of each scale for most accurate readings. Also measures peak-to-peak for FM and TV work. Ranges: AC P-P volts, 0-4-14-40-140-400-1400-4000; AC rms volts and DC volts, 0-1.5-5-15-50-150-500-1500; resistance, 0-1000-10K-100K ohms and 0-1-10-100-1000 megohms; db scale, -10 to +5. AC response, 30 cycles to 3 mc. Low-leakage switches and 1% precision resistors. Balanced-bridge circuit. 4 1/2" meter, 200 microamp movement. Polarity reversing switch. Input res., 11 megs. Shpg. wt., 6 lbs.

\$24⁹⁵

Model F-125 Printed Circuit VTVM Kit. Net only \$24.95
F-126. Hi-Voltage Probe; extends DC to 50,000 Volts \$4.75
F-127. Hi-Frequency Probe; extends AC to 250 mc. \$3.45

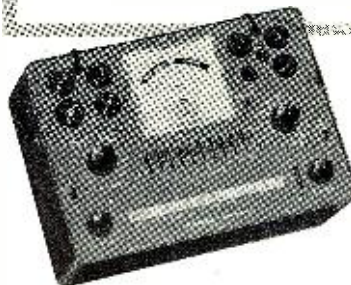

PORTABLE MODEL

Model F-143 knight-kit LOW-COST TUBE TESTER KIT

\$29⁷⁵ Offers high accuracy, top versatility and convenience at lowest cost. Tests 4, 5, 6 and 7-pin large, regular and miniature types, octals, localts, 9-pin miniatures and pilot lamps. Features test for new 600 ma series string tubes. Tests for open, short, leakage, heater continuity and quality (by amount of cathode emission). 4 1/2" square meter with clear "GOOD-?-REPLACE" scale. With line-voltage indicator and line-adjust control. Choice of 14 filament voltages from .63 to 117 volts. Blank socket for future type tubes. Universal-type selector switches for any combination of pin connections. Single-unit, 10-lever function switch. Entire switch assembly is installed as a single unit—saves time and greatly simplifies construction. Illuminated roll chart lists over 600 tube types. Shpg. wt., 14 lbs.

Model F-143. Counter Model Tube Tester Kit. Net only \$29.75

Model F-142. Portable Model Tube Tester Kit. Net only \$34.75

F-141. TV Picture Tube Adapter for above. Net only \$3.75



knight-kit LOW-COST

"IN-CIRCUIT" CAPACITOR CHECKER KIT

Tests capacitors while they are still wired in the circuit! Saves time and bother; an essential instrument for the service technician. Just press a button and the "magic eye" instantly shows opens and shorts (not leakage). Tests opens and shorts on any capacitor of 20 mmf or greater capacity, even if it is in parallel with a resistance as low as 50 ohms. Tests for shorts may be made on any capacitor even when it is shunted by as low as 20 ohms. Blue-finish steel case, 7 3/4 x 5 1/4 x 5". With tubes, all parts, wire and solder. Easy to assemble. Shpg. wt., 5 lbs.

Model F-119 \$12⁵⁰

Model F-119. Cap. Checker Kit \$12.50

order from **ALLIED RADIO** 100 N. WESTERN AVE., CHICAGO 80, ILL. →

ALLIED'S own MONEY-SAVING knight-kits

FAMOUS knight-kits FOR HOBBYISTS & EXPERIMENTERS... FASCINATING, INSTRUCTIVE...



knight-kit
"SPACE SPANNER"
BAND SWITCHING
RECEIVER KIT

Model S-243 \$15⁹⁵

Thrilling Short Wave and Broadcast

Famous 2-band AC-DC receiver in easy-to-build kit form at a very low price. Pulls in thrilling short-wave (6 to 17 mc) and standard broadcast. It's fun listening to amateur, aircraft, police and marine radio. Features highly sensitive regenerative circuit. Bandswitch selects broadcast or short wave. Has 4" PM speaker and beam-power output tube for plenty of volume; headphone connectors for weak signal listening; slide switch cuts out speaker. Uses 12AT7 regenerative detector and audio amplifier, 50C5 power output, 35W4 rectifier. Six controls: Bandspread; Main Tuning; Antenna Trimmer; Bandswitch; Regeneration; and Audio Gain. Includes tubes and all parts. 7 x 10½ x 6". Shpg. wt. 4½ lbs.

Model S-243. "Space Spanner" Receiver Kit. Net only \$15.95
S-247. Matching Cabinet for above. 2 lbs. Net \$2.90



Model S-295 \$14⁷⁵

NEW knight-kit TWO-WAY INTERCOM KIT

New low-cost, easy to build intercom system kit. Ideal for use in home or office. Consists of Master unit and Remote unit, each with press-to-talk switch. Remote unit may be left "open" for answering calls from a distance, for "babysitting", etc. Remote may also be connected for "private" operation—cannot be "listened-in" on, but it can be called and can originate calls. Master unit includes high-gain 2-stage amplifier; each unit has 4" PM dynamic speaker. Complete with Antique White cabinets (4¾ x 6½ x 4¾"), all parts, tubes and 50 feet of cable (up to 200 feet of cable can be added). For AC or DC. Shpg. wt., 7 lbs.

Model S-295. Two-Way Intercom Kit. Net only .. \$14.75



Model S-740 \$11⁷⁵

knight-kit

"OCEAN HOPPER" RECEIVER KIT

Tops for exciting broadcast, long wave and short wave reception. Highly sensitive regenerative-type circuit. Excellent headphone reception; can be used with 3-4 ohm PM speaker on strong broadcast band stations. Supplied with plug-in coil for standard broadcast; covers long wave and popular short wave bands with coils below. Pulls in thrilling foreign broadcasts, police, amateurs and aircraft. Controls: Main Tuning, Bandspread, Antenna Tuning, Off-On-Regeneration. With all parts and tubes (less extra coils and headset). AC or DC. Shpg. wt., 5 lbs.

Model S-740. "Ocean Hopper" Kit. \$11.75

EXTRA PLUG-IN COILS

S-741. Long Wave, 155-470 kc. Net 79¢
S-742. Short Wave, 1.65-470 kc. }
S-743. Short Wave, 2.9-7.3 mc. } Net
S-745. Short Wave, 7-17.5 mc. } each 65¢
S-744. Short Wave, 15.5-35 mc. }



Model S-735 \$17²⁵

knight-kit

"RANGER II" SUPERHET RADIO KIT

Thousands have built and enjoyed the "Ranger" Broadcast Band Receiver. Carefully engineered for easy construction and powerful, sensitive performance. Latest Superhet circuit; tunes 540 to 1680 kc; covers entire broadcast band and exciting police calls. Features automatic volume control, built-in preformed loop antenna, ball-bearing tuning condenser. Develops excellent tone quality from Alnico V PM dynamic speaker. Supplied with following tubes: 12SA7GT converter; 12SK7GT IF amp.; 12SQ7GT det.-AVC-audio; 50L6GT audio output; 35Z5GT rect. Complete with handsome brown plastic cabinet (6 x 9 x 5) tubes, speaker, all parts, and instruction manual. AC or DC operation. Shpg. wt., 8 lbs.

Model S-735. "Ranger II" Superhet Radio Kit. Net only \$17.25



Model S-730 \$19⁹⁵

knight-kit

3-WAY PORTABLE RADIO KIT

A low-cost portable radio covering the full standard broadcast band from 535 kc to 1650 kc. Delivers excellent reception on AC or DC current or from self-contained batteries. Sensitive Superhet circuit features automatic volume control, economical operation. Includes powerful 5" Alnico PM dynamic speaker, efficient ferrite loop-stick antenna. Supplied with following tubes: 1R5 converter; 1U4 IF amplifier; 1U5 detector-AVC-audio; 3V4 audio output. Complete with attractive portable case (7¾ x 10 x 5¼"), tubes, speaker, all parts and instruction manual. Shpg. wt., 6 lbs.

Model S-730. 3-Way Portable Radio Kit (less batteries). Net. \$19.95

J-651. Battery Kit for above \$2.50

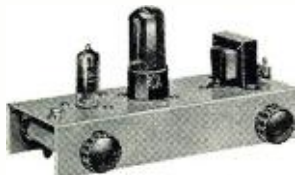

knight-kit LOW COST PHONO AMPLIFIER KIT

Model S-790 \$8⁹⁵

It's easy to build this fine-performing, low-cost compact phono amplifier. Ideal for use in a portable phonograph—simply add any record player and a 3 to 4-ohm speaker. Amplifier works with crystal or ceramic cartridges. Inverse feedback circuit for rich, clean tone quality. Delivers full 1½-watt output with less than .25 volt input. Includes efficient tone control; has AC outlet, controlled from amplifier switch. Complete with tubes and all parts. Size only 4½ x 7 x 4"—fits into almost any portable phono case. Shpg. wt., 3 lbs.

Model S-790. Phono Amplifier Kit. Net only \$8.95

FAMOUS knight-kit CRYSTAL SET KIT

Model S-261

\$2¹⁵

Thousands of beginners have started in radio and electronics by building the KNIGHT-KIT crystal set. This feature-packed set delivers loud, clear reception of local broadcast stations. A germanium crystal diode detector assures high sensitivity and simple operation—no crystal adjustment required. "Hi-Q" coil boosts sensitivity. Ball-bearing variable capacitor for easy tuning. With all parts and simple-to-follow instructions. Shpg. wt., 1 lb.

Model S-261. Crystal Set Kit. Net only \$2.15

S-267. Accessory Kit. 2000-ohm headphones and all parts for outdoor antenna \$2.95



Buy with confidence from ALLIED — America's Pioneer in Electronic Kits

finest quality electronic equipment in lowest-cost kit form

EASY-TO-BUILD HIGH PERFORMANCE KITS • WIDELY USED BY MANY LEADING TRAINING SCHOOLS



NEW knight-kit ELECTRONIC PHOTOFASH KIT

Model S-244
\$28⁵⁰

New feature-packed photoflash kit—designed for top quality dependability—available at a money-saving low price. Ideal for black and white or color photography. Xenon-filled reflector-bulb assembly gives over 10,000 flashes at less than 1/2¢ each! 1/700-second flash freezes the fastest action. Has 50 watt-second output. Provides light approximating daylight in spectral quality; permits the use of outdoor-type film indoors. Film guide number for color (ASA10) is 45. Designed for "X" or "O" shutters only. Requires sync cable (available from any photo supply dealer) and either battery or AC supply listed below. Complete outfit with battery weighs only 3 1/2 lbs. Kit includes all parts, carrying case and easy-to-follow instructions. Shpg. wt., 3 lbs.

Model S-244. Electronic Photoflash Kit. Net... **\$28.50**
S-246. AC Power Supply Kit. Easy to assemble... **\$3.75**
J-626. Battery for above (Burgess U-200)... **\$8.47**

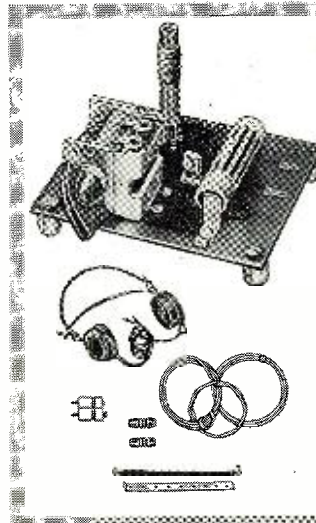

knight-kit TRANSISTOR RADIO KIT

Printed Wiring • Works from Penlight Cell

Model S-765 **\$4³⁵** Smooth Variable Capacitor Tuning

Experiment with the marvel of transistors! Printed circuit requires no wiring—just assemble with a few solder connections and enjoy excellent reception over the full AM broadcast band. No tubes to burn out—no crystal. Compact—fits in the palm of your hand—operates for months from a single penlight cell. Transistor provides plenty of power for strong headphone reception. Complete with all parts, transistor and penlight cell. Shpg. wt., 8 oz.

Model S-765. Transistor Radio Kit **\$4.35**
S-266. Accessory Kit. 4000-ohm headphones and all parts for outdoor antenna... **\$3.15**

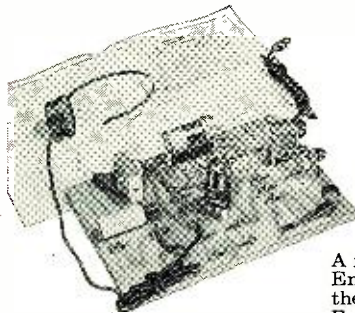

FAMOUS knight-kit LAB KITS

6-IN-1 RADIO LAB KIT

Model S-770 **\$7⁹⁵** Build Any of 6 Electronic Projects

A fascinating and instructive kit. Enables you to build any one of the following projects: Standard Broadcast Receiver; Wireless

"Home Broadcaster"; Code Practice Oscillator; Code Practice Broadcaster; Signal Tracer; Sine Wave Generator. Perfect for beginners. Once basic wiring is completed, circuits may be changed without soldering. Safe to build and operate; only tools needed are screwdriver, pliers and soldering iron. The ideal kit for students and beginners in electronics. Kit includes mounting board, tube, all parts and easy-to-follow instruction manual. Less headphone (also serves as mike). Shpg. wt., 6 lbs.

Model S-770. "6-in-1" Lab Kit. Net only... **\$7.95**
J-112. Single 1000-ohm headphone for above... **\$1.05**
C-100. Antenna kit for above... **\$1.05**

10-IN-1 LAB KIT

Model S-265 **\$12⁶⁵** Build Any of 10 Electronic Projects

A wonderfully instructive electronics kit. Ideal for experimenters, beginners—fun to build. Construct a sensitive Broadcast Receiver; Amplifier (for phono or mike); Wireless Phono Oscillator; Home "Broadcast Station"; Code Practice Oscillator; Capacity-Operated Relay, or any one of four other fascinating projects. Low voltages; safe to build and operate. Only tools needed are soldering iron, screwdriver and pliers. Perfect for self-instruction in circuit fundamentals, and packed with practical applications. Kit includes mounting board, tubes, all parts, hardware, microphone, and 12-page builders' manual. Shpg. wt., 10 lbs.

Model S-265. "10-in-1" Lab Kit. Net only... **\$12.65**
J-112. Single 1000-ohm headphone for above... **\$1.05**
C-100. Antenna Kit for above... **\$1.05**

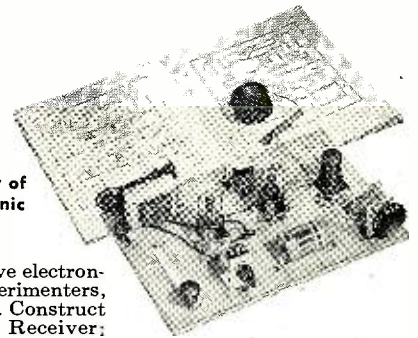

knight-kit WIRELESS BROADCASTER KIT

Model S-705 **\$9⁵⁰** This fascinating unit makes it possible to "broadcast" with phonograph or microphone through any standard radio receiver up to 50 feet away—without any connection to the set. May be used with crystal or magnetic cartridge, or with microphone.

Broadcasts a clear, full-toned signal. High-gain stage permits using magnetic cartridge without need for external preamp. Complete with all parts, tubes, wire and solder (less microphone). 4 1/2 x 5 x 6". Easy to assemble. Shpg. wt., 3 lbs.

Model S-705. Wireless Broadcaster Kit. Net only... **\$9.50**
S-556. Microphone for above with 5-ft. cable... **\$3.95**

knight-kit PHONO OSCILLATOR KIT

Model S-760 **\$5⁸⁵** This low-cost phono oscillator may be used with any crystal phonograph for "broadcasting" recorded music through any standard radio receiver up to 50 feet away. Requires no direct connection to radio set. Operates on any frequency between 600 and 800 kc. Has controls for adjustment of modulation level and selection of clear frequency on radio receiver. Uses 50L6GT tube and 35Z5GT rectifier. Complete with all parts, tubes and instructions. 4 1/4 x 4 1/2 x 4 1/2". Shpg. wt., 1 lb.

Model S-760. Phono Oscillator Kit. Net only... **\$5.85**



knight-kit CODE PRACTICE OSCILLATOR KIT

Model S-239 **\$3⁹⁵** Transistor Circuit—Powered by Penlight Cell

An ideal code practice oscillator. Uses transistor circuit. Extremely low current consumption—powered by single penlight battery. Provides crisp, clear tone (400 to 600 cps). Has input jack for earphone; screw-type terminal strip for key. In compact bakelite case (2 3/8 x 3 3/4 x 1 1/2") with anodized aluminum panel. Complete with all parts, transistor, battery and easy-to-follow instructions. Shpg. wt., 1 lb.

Model S-239. Code Practice Kit... **\$3.95**
See Next Page for Amateur Kits

ALL PRICES NET F.O.B. CHICAGO

order from **ALLIED RADIO** 100 N. WESTERN AVE., CHICAGO 80, ILL. →

ALLI D'S own knight-kits give you the most for your money

BUILD YOUR OWN QUALITY HI-FI AMPLIFIER!

knight-kit
BASIC 25-WATT
LINEAR-DELUXE
HI-FI AMPLIFIER KIT

Model S-755
\$44⁵⁰

Williamson-Type Circuit
 Printed Circuit Board
 Chrome-Plated Chassis



This super-quality hi-fi basic amplifier is designed to satisfy the most critical listener. Intended for use with tuners incorporating built-in preamp or with separate preamp. Incorporates latest Williamson-type circuit and has potted matched transformers. Delivers maximum output of 45 watts. Frequency response is: ± 0.5 db, 10 cps to 120 kc, measured at 20 watts. Harmonic distortion is only .15% right up to 30 watts. Intermodulation distortion is only .27% at 10 watts and only .4% at 20 watts, using 60 cps and 7 kc, 1:4 ratio. Hum level is -85 db below full rated output. Output impedance, 4, 8, 16 ohms. Input voltage for 25-watt output is 1.8 volts. Uses two 12AU7's, two 5881's, and a 5V4. Etched circuit is utilized in voltage amplifier and phase inverter stages to speed assembly. Has output tube balancing control, variable damping control, and on-off switch. Handsome chrome-plated chassis, 14 x 9 x 2". Overall height, 7". A deluxe true hi-fi amplifier equal in performance to amplifiers selling at over twice the price. Complete with all parts and tubes. Easy to assemble. Shpg. wt., 27 lbs.

Model S-755. Basic 25 Watt Hi-Fi Amplifier Kit. Net only..... **\$44.50**
 S-759. Metal enclosure for above; black finish. 3 lbs. Net..... **\$4.25**

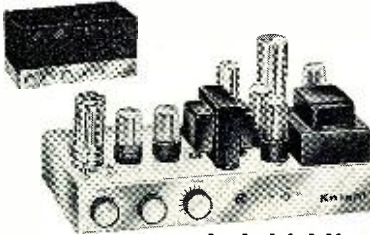

knight-kit
10-WATT HI-FI AMPLIFIER KIT

Model S-753
\$23⁵⁰

Chrome-Plated Chassis
 Famous for wide response and smooth reproduction at low cost. Only 0.5 volt drives amplifier to full output. Frequency response: ± 1 db, 30-20,000 cps at 10 watts. Harmonic distortion less than 0.5% at 10 watts. Intermod. distortion less than 1.5% at full output. Controls: on-off-volume, bass, treble. Input for crystal phono or tuner. Chromed chassis; punched to accommodate magnetic cartridge preamp. Matches 8 ohm speakers. Shpg. wt., 14 lbs.

Model S-753. Amplifier Kit. Net..... **\$23.50**
 Model S-235. Preamp Kit for above... **\$3.10**
 S-757. Metal Enclosure. 3 lbs..... **\$3.95**

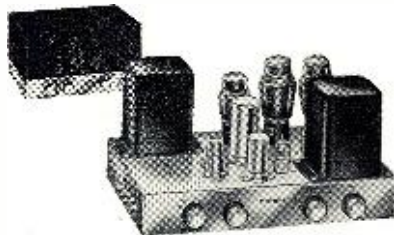

knight-kit
20-WATT HI-FI AMPLIFIER KIT

Model S-750
\$35⁷⁵

Chrome-Plated Chassis
 True hi-fi for less! Frequency response, ± 1 db, 20-20,000 cps at 20 watts. Distortion, 1% at 20 watts. Hum and noise level: tuner input, 90 db below 20 watts; phono 72 db below 20 watts. 4 inputs: magnetic phono, microphone, crystal phono or recorder, and tuner. Controls: Bass, Treble, Volume, Selector. With compensation positions for 78 and LP records. Built-in Preamp. Outputs: 4, 8, 16 and 500 ohms. 23 lbs.

Model S-750. 20-Watt Kit. Net..... **\$35.75**
 S-758. Metal Enclosure. 3 lbs..... **\$4.15**
 S-752. Chrome-plated escutcheon for cabinet installation of amplifier. Net..... **\$1.40**

LOW-COST TOP QUALITY KITS FOR THE HAM

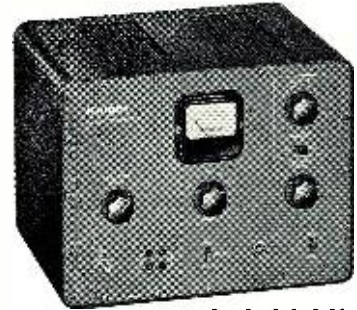

knight-kit
Model S-255 50-WATT CW TRANSMITTER KIT
\$38⁹⁵
Built-in Pi-Type Antenna Coupler

Check the features packed into this new transmitter kit and you'll see why it's one of the greatest Amateur values ever offered. Compact and versatile, it is the perfect low-power rig for the beginning Novice or seasoned veteran. Features: 50 watts input to 807 final; high-efficiency 6AG7 modified-Pierce oscillator takes crystal or VFO without circuit changes; bandswitching coverage of 80, 40, 20, 15, 11-10 meters; pi-section antenna output matches line impedances from 50 to 1200 ohms —permits use with any type of antenna; no separate antenna tuner required. Crisp, clean, cathode keying of oscillator and final. Power take-off plug supplies filament and B-plus voltages for other equipment. Copper-finished chassis and cabinet interior, filtering, shielding, bypassing and coaxial SO-239 antenna connector provide excellent TVI suppression. Meter reads either plate or grid current of final. Jacks for VFO, crystal and key. Supplied with all parts and tubes. Less crystal and key. $8\frac{3}{8}$ x $11\frac{1}{8}$ x $8\frac{3}{4}$ ". Shpg. wt., 18 lbs.

Model S-255. 50-Watt Transmitter Kit. Net... **\$38.95**



knight-kit
SELF-POWERED
VFO KIT

Model S-725
\$28⁵⁰

Complete with built-in power supply! Careful design and voltage regulation assure high stability. Excellent oscillator keying characteristics for fast break-in without clicks or chirps. Full TVI suppression. Has plenty of bandspread: separate calibrated scales for 80, 40, 20, 15, 11 and 10 meters; vernier drive mechanism. 2-chassis construction keeps heat from frequency determining circuits. Output cable plugs into crystal socket of transmitter. Output on 80 and 40 meters. With Spot-Off-Transmit switch for "no swish" tuning. Extra switch contacts for operating relays and other equipment. With all parts and tubes. 8 lbs.

Model S-725. Self-Powered VFO Kit. Net..... **\$28.50**



NEW knight-kit
AMATEUR RF
"Z" BRIDGE KIT

Model S-253
\$5⁸⁵

Measures standing wave ratio (SWR) and impedance of antenna systems; also for adjusting antenna networks for optimum results. Any VOM may be used for null indicator. High accuracy with 20,000 ohm/v VOM. Correction factor info supplied for other VOM's. With coax input and output connectors. Meters both input and bridge voltage. Calibrated dial gives direct impedance reading; includes 1% precision resistor for precise calibration adjustment. With all parts and handy plasticized SWR chart. $1\frac{1}{2}$ lbs.

Model S-253. "Z" Bridge Kit. Net only... **\$5.85**

ALLIED RADIO

100 N. WESTERN AVE., CHICAGO 80, ILL.

Our
 35th year

ALLIED RADIO CORP., Dept. 01-C-7, 100 N. Western Ave., Chicago 80, Ill.

Ship me the following KNIGHT-KITS:

Quantity	Description	Model No.	Price

\$_____ enclosed. For parcel post include postage (express is shipped collect).

Name _____

Address _____

City _____ Zone _____ State _____

← *order Today*

LATEST ALLIED knight-kits



NEW for the
Serviceman

knight-kit
FLYBACK
CHECKER KIT

Model
Y-118 **\$19.50**

Race through TV deflection circuit repairs for extra servicing profits with this new Flyback and Yoke Tester! Instantly checks all types of standard horizontal output transformers as well as linearity and width coils. Positively indicates shorted turns for any coil with a "Q" greater than 1, and inductance between .003 and 2 henries. Determines continuity of any circuit with resistance from zero to .5 meg. Checks wider range of inductances than any other similar unit. Has highly legible $4\frac{1}{2}$ " meter. Uses 6S4-A pulsed oscillator circuit. Supplied with all parts and test leads. $7\frac{1}{4} \times 5\frac{1}{4} \times 5"$. Shpg. wt. $5\frac{1}{2}$ lbs.

Model Y-118, Flyback Checker Kit. **\$19.50**
Net.....



NEW for the Ham

knight-kit
100 KC CRYSTAL
CALIBRATOR KIT

Model
Y-256 **\$10.50**

New universal frequency calibrator to fit any communications receiver—priced so low every Ham

can afford it. Uses hermetically-sealed 100 KC crystal. Generates 100 KC markers all the way up to 35 mc. Compact case is only $3 \times 1\frac{1}{2} \times 1\frac{1}{2}$ "; has universal mounting flanges for mounting in any of several positions. Requires only 6.3 v. at .15 amps and 150-350 v. at 3-6 ma. Includes crystal zeroing trimmer and on-off switch which mounts on case. Connects to receiver input. Uses 6AK6 as electron-coupled oscillator. Complete with formed and punched case, 100 KC crystal, tube, all parts and instructions. Shpg. wt., 1 lb.

Model Y-256, Crystal Calibrator Kit. **\$10.50**
Net.....

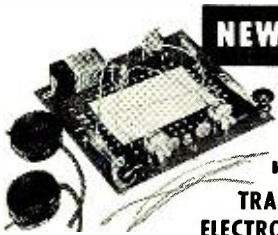

NEW for the
Experimenter

knight-kit
TRANSISTORIZED
ELECTRONIC LAB KIT

Model
Y-299 **\$15.45**

It's sensational—learn how transistors operate—see all the projects you can make with this all-

new electronic marvel! You just assemble the basic parts once. Then you complete project after project (10 in all), just by inserting the "plug-in" leads into the proper jacks on the printed-circuit board—without additional soldering! You can complete and enjoy any of these: a fine AM radio; a wireless home "broadcaster"; phono amplifier; code practice oscillator; electronic timer, switch or flasher; voice-operated, capacity-operated and photoelectric relays. It's the most fascinating experimenters' kit ever developed! Includes all parts, two transistors, battery, headphones and special cards showing you how to plug in each project. Shpg. wt., 3 lbs.

Model Y-299, Transistorized Lab Kit. **\$15.45**
Net.....

Three-Channel Amplifier

(Continued from page 68)

control are included since these functions can be provided by a preamplifier. The four-prong Jones plug permits heater and "B-plus" connections for a preamplifier. It can be eliminated or changed to an octal socket, which is quite popular for this purpose.

Many of the surplus TV power transformers on the market are ideal for this amplifier. If an extra 6.3 volt winding is available, wire it to the pre-amp power plug. If the regular 6.3 volt winding has a center tap, use it and omit R_{71} and R_{72} .

Because the individual channel amplifiers have considerable gain, care must be taken in the wiring to avoid hum and noise. Use good quality resistors and wire all ground points together.

The two electrostatic speakers are wired in series. Single-conductor shielded cable is good for connecting the speakers to the amplifier. Unless coaxial cable is used, this interconnecting wire should be less than 15 feet. While no enclosure is needed for the electrostatic speakers for acoustical reasons, something is necessary to hold them in position. The author built a small thin cabinet that positions the two speakers with a horizontal angle of approximately 45° between them.

It should be possible to set the channel gain controls once and not alter them again. Adjust the mid-range gain first to get a suitable volume level, the low-range next, and finally the high-range. The control for the weakest channel should be at maximum with the others adjusted as required.

One problem with the mid-range amplifier showed up when an efficient horn-type mid-range unit was tried, namely, an audible hiss introduced in the 6AU6 (V_3) stage. Therefore, if the builder plans to use an efficient mid-range unit, he may want to make the following circuit changes: Replace the 6AU6 with a 6AV6 triode, eliminate R_{20} and C_{12} ; change R_{27} to 2700 ohms and change R_{30} to 39,000 ohms. These changes are optional and have no effect on over-all performance other than to reduce the small hiss that can be heard in the horn unit during periods of no signal.

The author has found the two electrostatic speakers to be highly satisfactory. With switches on the amplifier and speaker cabinet to switch from a conventional to an "electronic" crossover, a small but immediately noticeable improvement with separate amplifiers for the woofer and mid-range speaker is noted. The construction of this amplifier, which originally was undertaken as an experiment to determine the usefulness of these two innovations, has turned out to be a worthwhile improvement to the author's home music system.

-30-

SENSATIONAL NEW knight-kit HI-FI FM TUNER KIT



knight-kit
HI-FI BASIC FM TUNER KIT

Model Y-751

\$37.75

- Featuring deluxe custom high-fidelity styling
- With latest AFC and Flywheel Tuning Control
- Latest printed circuit—no critical wiring required



Advanced Tuner Circuit—noise-free and highly sensitive. Automatic Frequency Control "locks in" on station; AFC disabling feature helps tune in weak stations.



Flywheel Tuning—Weighted flywheel tuning mechanism permits velvet-smooth, accurate station selection over entire band.



Printed Circuit—all critical wiring is already completed—greatly simplifies assembly and reduces wiring time. Circuit board clearly shows placement of basic components.

INCOMPARABLE HI-FI KIT VALUE

Here is not only the best-looking tuner kit your money can buy, but the only FM tuner kit offering all these features: *Printed circuit* for easy assembly; *automatic frequency control* for "lock-in" tuning of stations, with disabling feature for tuning in weak stations; *pre-adjusted RF coils on rigid forms*—no further adjustment required; *pre-aligned I.F.'s*; *front ventilation*—an integral part of panel design (no unsightly perforations on cabinet.)

SPECIFICATIONS: *Tuning Range:* 88-108 mc. *Output:* 2 volts at 1000 microvolt input. *IF Bandwidth:* 200 kc. *Audio Response:* 20-20,000 cps with only 0.6% distortion. *2 Output Jacks:* one for feeding amplifier, the other for tape recorder. *Sensitivity:* 10 microvolts for 20 db quieting across entire band. Cascode broadband RF amplifier. Drift-compensated oscillator. Ideal for use with the Model S-750 KNIGHT-KIT 20-Watt Amplifier kit (see opposite page), or any amplifier equipped with phono-tuner switch. In beautiful gray cabinet with polished aluminum control panel; $4 \times 13 \times 8"$; illuminated lucite pointer highlights station selection. Complete, ready for easy assembly. Shpg. wt., 12 lbs.

Model Y-751, Basic FM Tuner Kit. **\$37.75**
Net.....

SPECIAL TUNER-AMPLIFIER OFFER

Exclusive hi-fi value—the new FM tuner kit, plus the 20-watt amplifier kit on opposite page (including metal enclosure) for only \$73.65! Buy this matched Hi-Fi combination and save \$4.00! Shpg. wt. 35 lbs. Y-761, Knight-Kit Tuner and 20-Watt Amplifier. Net..... \$73.65
Only \$7.37 down on our Easy Pay Plan

← use order blank
on opposite page

← ORDER FROM **ALLIED RADIO**
use order blank on opposite page

Superior's New Streamlined Model TD-55

TUBE TESTER



FOR

The Experimenter or Part-time Serviceman, who has delayed purchasing a higher priced Tube Tester.

The Professional Serviceman, who needs an extra Tube Tester for outside calls.

The Busy TV Service Organization, which needs extra Tube Testers for its field men.

CHECKS FOR SHORTS AND LEAKAGES BETWEEN ALL ELEMENTS — Model TD-55 provides a super sensitive method of checking for shorts and leakages up to 5 Megohms between any and all of the terminals. Continuity between various sections is individually indicated. **"FREE-POINT" ELEMENT SWITCHING SYSTEM** — Model TD-55 incorporates a newly designed element selector switch system which reduces the possibility of obsolescence to an absolute minimum. Any pin may be used as a filament pin and the voltage applied between that pin and any other pin, or even the "top-cap." **ELEMENTAL SWITCHES ARE NUMBERED IN STRICT ACCORDANCE WITH R.M.A. SPECIFICATION** — The 4 position fast-action snap switches are all numbered in exact accordance with the standard R.M.A. numbering system. Thus, if the element terminating in pin No. 7 of a tube is under test, button No. 7 is used for that test.

Speedy, yet efficient operation is accomplished by: 1. Simplification of all switching and controls. 2. Elimination of old style sockets used for testing obsolete tubes (26, 27, 57, 59, etc.) and providing sockets and circuits for efficiently testing the new Noval and Sub-Minar types.

Model TD-55 comes complete with operating instructions and charts. Housed in rugged steel cabinet. Use it on the bench—use it for field calls. A streamlined carrying case, included at no extra charge, accommodates the tester and book of instructions.

\$26.95
NET

Superior's New Model TV-12 **TRANS-CONDUCTANCE**

TUBE TESTER



TESTING TUBES

★ Employs improved **TRANS-CONDUCTANCE** circuit. An in-phase signal is impressed on the input section of a tube and the resultant plate current change is measured. This provides the most suitable method of simulating the manner in which tubes actually operate in Radio & TV receivers, amplifiers and other circuits. Amplification factor, plate resistance and cathode emission are all correlated in one meter reading.

★ **NEW LINE VOLTAGE ADJUSTING SYSTEM.** A tapped transformer makes it possible to compensate for line voltage variations to a tolerance of better than 2%.

ALSO TESTS TRANSISTORS!

★ **SAFETY BUTTON**—protects both the tube under test and the instrument meter against damage due to overload or other form of improper switching.

★ **NEWLY DESIGNED FIVE POSITION LEVER SWITCH ASSEMBLY.** Permits application of separate voltages as required for both plate and grid of tube under test, resulting in improved Trans-Conductance circuit.

TESTING TRANSISTORS

A transistor can be safely and adequately tested only under dynamic conditions. The Model TV-12 will test all transistors in that approved manner, and quality is read directly on a special "transistor only" meter scale.

Model TV-12 housed in handsome rugged portable cabinet sells for only

\$72.50
NET

Superior's New Model TV-60

20,000 OHMS PER VOLT

ALLMETER

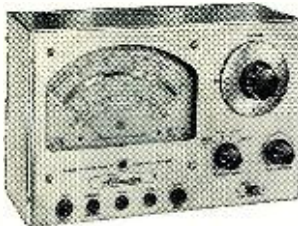

SPECIFICATIONS

8 D.C. VOLTAGE RANGES (At a sensitivity of 20,000 Ohms per Volt) 0 to 15/75/150/300/750/1500/7500/30,000 Volts.
7 A.C. VOLTAGE RANGES: (At a sensitivity of 5,000 Ohms per Volt) 0 to 15/75/150/300/750/1500/7500 Volts.
3 RESISTANCE RANGES: 0 to 2,000/200,000 Ohms, 0-20 Megohms.
2 CAPACITY RANGES: .00025 Mfd. to 30 Mfd.
5 D.C. CURRENT RANGES: 0-75 Microamperes, 0 to 7.5/75/750 Milliampere, 0 to 15 Amperes.
3 DECIBEL RANGES: -6 db to +58 db.
R.F. SIGNAL TRACER SERVICE: Enables following the R.F. signal from the antenna to speaker of any radio or TV receiver and using that signal as a basis of measurement to first isolate the faulty stage and finally the component or circuit condition causing the trouble.

AUDIO SIGNAL TRACER SERVICE: Functions in the same manner as the R.F. Signal Tracing service specified at right except that it is used for the location of cause of trouble in all audio and amplifier systems.

FEATURES

Giant recessed 6½ inch 40 Microampere meter with mirrored scale. Built-in Isolation Transformer. Use of the latest type printed circuit and 1% multipliers assure unchanging accurate readings.

Model TV-60 comes complete with book of instructions; pair of standard test leads; high-voltage probe; detachable line cord; R.F. Signal Tracer Probe and Audio Signal Tracer Probe. Pliofilm bag for all above accessories is also included. Price complete. Nothing else to buy. **ONLY**

\$52.50
NET

Superior's New Model 670-A

SUPER METER

A Combination **VOLT-OHM MILLIAMMETER PLUS** Capacity, Reactance, Inductance and Decibel Measurements.



ADDED FEATURE:

Built in **ISOLATION TRANSFORMER** reduces possibility of burning out meter through misuse.

SPECIFICATIONS

D.C. VOLTS: 0 to 7.5/15/75/150/750/1,500/7,500 Volts
A.C. VOLTS: 0 to 15/30/150/300/1,500/3,000 Volts
OUTPUT VOLTS: 0 to 15/30/150/300/1,500/3,000 Volts
D.C. CURRENT: 0 to 1.5/15/150 Ma. 0 to 1.5/15 Amperes
RESISTANCE: 0 to 1,000/100,000 Ohms 0 to 10 Megohms

CAPACITY: .001 to 1 Mfd. 1 to 50 Mfd. (Good-Bad scale for checking quality of electrolytic condensers.)
REACTANCE: 50 to 2,500 Ohms 2,500 Ohms to 2.5 Megohms
INDUCTANCE: .15 to 7 Henries 7 Henries to 7,000 Henries
DECIBELS: -6 to +18 +14 to +38 +34 to +58

The Model 670-A comes housed, in a rugged crackle-finished steel cabinet complete with test leads and operating instructions.

\$28.40
NET

Superior's New Model TV-50

GENOMETER

A versatile all-inclusive **GENERATOR** which provides **ALL** the outputs for servicing:
A. M. Radio • F. M. Radio • Amplifiers • Black and White TV • Color TV

7 Signal Generators in One!

- ✓ R.F. Signal Generator for A.M.
- ✓ R.F. Signal Generator for F.M.
- ✓ Audio Frequency Generator

- ✓ Bar Generator
- ✓ Cross Hatch Generator
- ✓ Color Dot Pattern Generator
- ✓ Marker Generator

R. F. SIGNAL GENERATOR: The Model TV-50 Genometer provides complete coverage for A.M. and F.M. alignment. Generates Radio Frequencies from 100 Kilocycles to 60 Megacycles on fundamentals and from 60 Megacycles to 180 Megacycles on powerful harmonics.

MARKER GENERATOR: The Model TV-50 includes all the most frequently needed marker points. The following markers are provided: 189 Kc., 262.5 Kc., 436 Kc., 600 Kc., 1000 Kc., 1400 Kc., 1600 Kc., 2000 Kc., 2500 Kc., 3579 Kc., 4.5 Mc., 5 Mc., 10.7 Mc., (3579 Kc. is the color burst frequency.)

VARIABLE AUDIO FREQUENCY GENERATOR: In addition to a fixed 400 cycle sine-wave audio, the Model TV-50 Genometer provides a variable 300 cycle to 20,000 cycle peaked wave audio signal.

BAR GENERATOR: The Model TV-50 projects an actual Bar Pattern on any TV Receiver Screen. Pattern will consist of 4 to 16 horizontal bars or 7 to 20 vertical bars.

CROSS HATCH GENERATOR: The Model TV-50 Genometer will project a cross-hatch pattern on any TV picture tube. The pattern will consist of non-shifting horizontal and vertical lines interlaced to provide a stable cross-hatch effect.

THE MODEL TV-50 comes absolutely complete with shielded leads and operating instructions.

Only

\$4750
NET

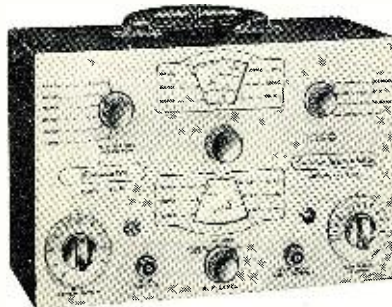

DOT PATTERN GENERATOR (FOR COLOR TV): Although you will be able to use most of your regular standard equipment for servicing Color TV, the one addition which is a "must" is a Dot Pattern Generator. The Dot Pattern projected on any color TV Receiver tube by the Model TV-50 will enable you to adjust for proper color convergence.

EXAMINE BEFORE YOU BUY!
USE APPROVAL FORM ON NEXT PAGE

For the first time ever: ONE TESTER PROVIDES ALL THE SERVICES LISTED BELOW!

Superior's
New Model **76**



Specifications

IT'S A CONDENSER BRIDGE

with a range of .00001 Microfarad to 1000 Microfarads (Measures power factor and leakage too.)

IT'S A RESISTANCE BRIDGE

with a range of 100 ohms to 5 megohms

IT'S A SIGNAL TRACER

which will enable you to trace the signal from antenna to speaker of all receivers and to finally pinpoint the exact cause of trouble whether it be a part or circuit defect.

IT'S A TV ANTENNA TESTER

The TV Antenna Tester section is used first to determine if a "break" exists in the TV antenna and if a break does exist the specific point (in feet from set) where it is.

✓CAPACITY BRIDGE SECTION

4 Ranges: .00001 Microfarad to .005 Microfarad; .001 Microfarad to .5 Microfarad; .1 Microfarad to 50 Microfarads; 20 Microfarads to 1000 Microfarads. This section will also locate shorts, and leakages up to 20 megohms. And finally, this section will measure the power factor of all condensers from .1 to 1000 Microfarads. (Power factor is the ability of a condenser to retain a charge and thereby filter efficiently.)

✓RESISTANCE BRIDGE SECTION

2 Ranges: 100 ohms to 50,000 ohms; 10,000 ohms to 5 megohms. Resistance can be measured without disconnecting capacitor connected across it. (Except, of course, when the R C combination is part of an R C bank.)

✓SIGNAL TRACER SECTION

A built-in high gain pentode voltage amplifier, plus a diode rectifier, plus a direct coupled triode amplifier are combined to provide this highly sensitive signal tracing service. With the use of the R.F. and A.F. Probes included with the Model 76, you can make stage gain measurements, locate signal loss in R.F. and Audio stages, localize faulty stages, locate distortion and hum, etc. Provision has been made for use of phones and meter if desired.

✓TV ANTENNA TESTER SECTION

Loss of sync., snow and instability are only a few of the faults which may be due to a break in the antenna, so why not check the TV antenna first? The Model 76 will enable you to locate a break in any TV antenna and if a break does exist, the Model 76 will measure the location of the break in feet from the set terminals. 2 Ranges: 2' to 200' for 72 ohm coax and 2' to 250' for 300 ohm ribbon.

As Design Engineers, we the undersigned would like to say that the Model 76 is in our opinion the best combination unit of its kind we have been privileged to design. Although it is comparatively a low-priced tester, it will, after you become acquainted with its multiple services, be your most frequently used instrument.

**S. LITT
L. MELNKEVITZ**

Model 76 comes complete with all accessories, including R.F. and A.F. Probes; Test Leads and operating Instructions. Nothing else to buy. Only

\$26⁹⁵ NET

**SHIPPED ON APPROVAL
NO MONEY WITH ORDER — NO C. O. D.**

Try any of the instruments on this or the facing page for 10 days before you buy. If completely satisfied then send down payment and pay balance as indicated on coupon. **No Interest or Finance Charges Added!** If not completely satisfied return unit to us, no explanation necessary.

MOSS ELECTRONIC DISTRIBUTING CO., INC.
Dept. D-330, 3849 Tenth Ave., New York 34, N. Y.

Name

Address

City Zone State

All prices net, F.O.B., N. Y. C.

<input type="checkbox"/> Model TV-60..... Total Price \$52.50 \$12.50 within 10 days. Balance \$8.00 monthly for 5 months.	<input type="checkbox"/> Model TV-50..... Total Price \$47.50 \$11.50 within 10 days. Balance \$6.00 monthly for 6 months.	<input type="checkbox"/> Model TD-55..... Total Price \$26.95 \$6.95 within 10 days. Balance \$5.00 monthly for 4 months.
<input type="checkbox"/> Model 670-A . . . Total Price \$28.40 \$7.40 within 10 days. Balance \$3.50 monthly for 6 months.	<input type="checkbox"/> Model 76 . . . Total Price \$26.95 \$6.95 within 10 days. Balance \$5.00 monthly for 4 months.	<input type="checkbox"/> Model TV-12..... Total Price \$72.50 \$22.50 within 10 days. Balance \$10.00 monthly for 5 months.

Europe's
largest selling
electronic tubes
...and at standard prices!

TELEFUNKEN

electronic pioneer
since 1903



**NOT A REPLACEMENT
BUT AN IMPROVEMENT!**

**NO
RETURNS**
**NO
MICROPHONICS.**
**NO
DISTORTION**
**NO
COMPROMISE
WITH
QUALITY**

Write for your Telefunken Tube Manual and
for the name of your nearest jobber.

Exclusively imported by

AMERICAN ELITE, INC.

Dept. X, 7 Park Avenue, New York 16, N. Y.

Exclusive importers also of Hi-Fi Home Systems,
Microphones and Hi-Fi FM Car Radios.

What's



New in Radio

IGNITION INDICATOR

Kar-Aids, Inc., 25-11 49th St., Long Island City 3, N. Y., is now marketing a compact and inexpensive indicating device which gives the car's driver a clear visual picture of his spark.

The device itself is a gas-filled bulb which is mounted on the dash which

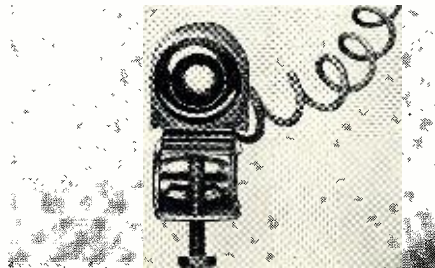

provides the driver with ignition information without leaving his seat. The device indicates whether the trouble exists in the ignition or fuel systems when starting trouble is encountered, thus avoiding unnecessary battery discharge. The unit reflects the engine load when the car is underway, thus making possible a reduction in gasoline consumption and contributing to economy of operation. Any increase in engine load, such as failure to release brake or reduced tire pressure, is reflected by a change of intensity of the light on the dash.

The device itself draws no power and will not affect any other circuits. Moderately priced, full details on the unit are available from the manufacturer.

FLAT SELENIUM RECTIFIERS

Radio Receptor Company, Inc., 240 Wythe Ave., Brooklyn, N. Y., is now importing and distributing a new line of flat selenium rectifiers made in West Germany by the *Siemens Companies*.

The new units which are smaller

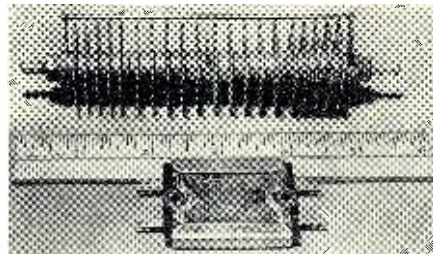

and lighter than comparable stack assemblies, but provide equal or more power, are especially suitable for applications requiring extremely compact design.

The new flat rectifiers come in a variety of sizes. For full details on the line write for the company's Bulletin No. 237, which is available without

charge from the Semiconductor Division.

SWEEP GENERATOR

Jerrold Electronics Corporation, 23rd and Chestnut Sts., Philadelphia 3, Pa. is in production on a versatile wide-band sweep frequency generator which has been especially designed for laboratory or production testing applications.

Designated as the Model 900, the new unit supplies a sweep signal at any frequency from .2 mc. to approximately 1000 mc. with sweep widths as high as 300 mc. or as low as .1 mc.

The r.f. output, which is monitored carefully by matched crystal diodes feeding a two-stage a.g.c. amplifier, is flat within ± 5 db over the entire 200 kc. to 250 mc. range. At a maximum

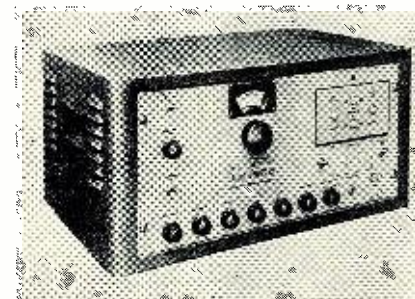

sweep width of 300 mc., the total r.f. output variation of the range 250 to 1000 mc. is less than ± 3 db.

The company also makes two sweep generator models in portable versions. For information on any or all of these instruments, write the manufacturer direct.

MINIATURIZED DISC CERAMICS

Sprague Products Co., North Adams, Mass., is now offering a new line of miniaturized ceramic capacitors designed especially for transistor portables and other miniature gear.

The new units are available in the five most popular values of capacitance from .005 to .1 μ fd. rated at 50 volts, d.c.

NEW MARKER-ADDER

Precision Apparatus Co., Inc., 70-31 84th St., Glendale 27, Long Island, N. Y., is now marketing a new marker-adder which is designed to improve the accuracy and versatility of the conventional sweep generator, signal-marker generator, and oscilloscope.

The model 220 is said to make for faster and more accurate r.f. and i.f. alignment in TV receivers as well as FM sets by permitting the use of large-size, highly visible markers with-

out distorting the sweep response curve; by eliminating the need to connect the marker-signal generator to the tuned circuits of the receiver; by making the marker pip fully visible in traps and at other zero response points,



thus simplifying and speeding adjustments at these critical points; and by preventing the marker signal from overloading the tuned circuits of the receiver, thus preserving the true shape of the sweep response curve.

The instrument comes complete with four connecting cables and a comprehensive instruction manual.

TINY TRANSISTOR RADIO

Gardner Electronics Co., 2545 E. Indian School Road, Phoenix, Ariz., is merchandising a new ultraminiature, four-transistor pocket radio which is being offered in both kit and wired forms.

Housed in a case measuring only 2 7/8" x 2" x 1", the receiver will tune the broadcast band. A hearing-aid type earphone provides adequate volume for personal listening. Battery life is estimated at 600 hours.

The receiver weighs 3 1/2 ounces, including the batteries. Printed circuitry and four long-life transistors insure trouble-free operation. No external antenna is required. Write the manufacturer for a data sheet on this and other transistor radios and prices on kit and wired versions.

COPPER-CLAD SHEETS

Keil Engineering Products, 4356 Duncan Ave., St. Louis 10, Mo., is now offering a line of photosensitized, copper-clad sheets for industrial and laboratory applications. With these sheets

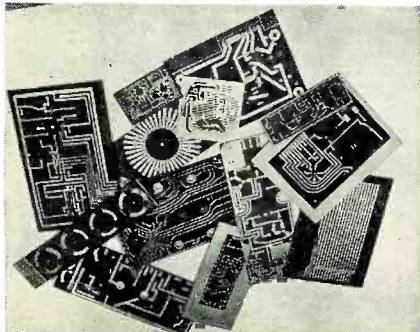

any etched circuit panel may be produced in any quantity on the user's premises. The processing chemicals and supplies are also available or may

March, 1957

IT'S THE BIGGEST AND BEST EVER

FREE THE GIANT ALL NEW 1957 BA CATALOG

A COMPLETE BUYING GUIDE FOR EVERYTHING IN . . .

RADIO • TV ELECTRONICS

1957 BA

ANNUAL CATALOG NO. 571

COMPLETE INDEX PAGE 170

DEALERS, SERVICE MEN, SCHOOLS, THEATRES, PUBLIC LABORATORIES, ENGINEERS, AMATEURS

BURSTEIN-APPLEBEE CO. Dept. M,
1012-14 McGee St., Kansas City 6, Mo.

Send Free B-A Catalog No. 571.

NAME _____

ADDRESS _____

CITY _____ STATE _____

RUSH COUPON TODAY!

172 KING-SIZED PAGES

EVERYTHING IN RADIO TV AND ELECTRONICS

100'S OF NEW ITEMS LISTED HERE FOR 1ST TIME

21 PAGES OF BARGAINS NOT IN ANY OTHER CATALOG

FREE! COMIC AD CARD KIT

FREE CATALOG TOO!—shows our complete line of TV Service Reports, Call Books, Phone Message Books, Job Tickets, Service Pricing Guide, File Systems, Service Contracts, Parts Warranties, P. O. Forms, Statement Books, Label Books, Sketch Pads, Cash Books, etc. See them at your parts jobber. **WRITE NOW!**

Oelrich Publications 4308 Milwaukee Ave. Chicago 41, Illinois

SCHEMATICS—CONVERSIONS FOR SURPLUS GEAR

NEW LIST DI! MANY ADDITIONS!
Send stamped, self addressed envelope for List D. Add 25¢ for chart explaining AN nomenclature. **DO IT TODAY!**

R. E. BOX 1220
GOODHEART BEVERLY HILLS, CAL.

LEARN TV

'At the most practical school in the west'

Work on late model sets—using modern equipment and service techniques: under qualified technician instructors. Short resident and correspondence courses—no unnecessary math or theory—also UHF and Color TV.

APPROVED FOR VETERANS . . . day and night classes.
Write for free literature, Dept. IA for residence—Dept. IAC for correspondence.

V.S.I. TELEVISION SCHOOL 4570 Firestone Blvd., Box 359 South Gate, California

HARVEY has it... TELREX '57 Beam Antennas

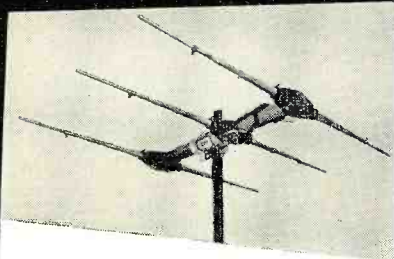

Commercial grade arrays at amateur prices; superior in performance, design and construction to any other antenna. Hair-pin resonated, precision tuned, matched and calibrated. Provide highest signal-to-noise ratio possible; 75% reduction in precipitation static.

FEATURES

- Extremely rugged elements of advanced sectional design; taper-swaged to reduce useless wind drag and silhouette by 55%.
- Special sturdy molded element support made of Borg-Warner "Cyclocac", a very high impact thermoplastic resin; holds, insulates and capacity-couples element to the boom for automatic dissipation of precipitation static.
- Stainless-steel airplane-type clamp, holds element sections firmly in exact position.
- Precisely constructed and the famous Telrex "Balun" help produce outstanding performance per element, clean-cut balanced pattern and minimum TVI.
- Single, heavy-wall aluminum boom is small in size, rugged in strength, and light in weight.
- Stainless steel "Hairpin" grounding lug provides element grounding at voltage node for lightning protection.

"SERIES 57" SPECIFICATIONS AND PRICES

Telrex No.	Meter Band	Elements No.	Gain db	Shpg. Wt. Lbs.	Amateur Net Each
3/4 M-15C	3/4	15	16.2	13	\$ 29.00
1/4 M-5C	1/4	5	11.9	3	6.95
1/4 M-15C	1/4	15	16.2	16 1/2	31.00
2M-3C	2	3	9.1	2 1/4	5.95
2M-5C	2	5	10.5	3	7.25
2M-6C	2	6	12.7	4	12.50
2M-8C	2	8	13.5	10	13.75
2M-808†	2	16	10.5	15	33.50
2M-15C	2	15	16.2	28	39.25
6M-3D	6	3	9.4	7	16.25
6M-4C	6	4	9.7	10	19.75
6M-6C	6	6	12.7	20	57.50
6M-36-135§	6	6	12.7	44	135.00
1030-S	10	3	7.0	9	36.50
10M-57-79†	10	3	8.9	27	79.50
10M-57-120†	10	4	10.1	33 1/2	120.00
10M-57-185§	10	5	11.2	77	185.00
10M-57-235§	10	6	12.7	93	235.00
1130-S	11	3	7.0	9 1/2	38.50
15M-57-67†	15	2	4.8	22	67.50
15M-57-99†	15	3	8.9	32	99.50
15M-57-118†	15	4	9.7	37	118.00
15M-57-198§	15	4	11.1	64	198.00
15M-57-245§	15	5	11.9	94	245.00
20M-57-79	20	2	4.8	26	79.50
20M-57-112†	20	3	8.7	33	112.50
20M-57-149§	20	3	9.0	56	149.50
20M-57-168§	20	3	9.4	63	168.50
20M-57-235§	20	4	10.4	74	235.00
20M-57-265§	20	4	11.2	90	265.00
40M-57-180	40	2	3.1	66	180.00
40M-57-295§	40	2	3.6	88	295.00
40M-57-265§	40	3	8.3	130	365.00
80M-57-370	80	2	3.2	120	370.00

†Circular polarized. ‡Deluxe Model.
§Super Deluxe Model.

**MAIL ORDERS SHIPPED
SAME DAY AS RECEIVED**

Include with payment an allowance for shipping charges. Prices subject to change without notice.

**HARVEY RADIO
CO., INC.** Estab. 1927

1123 Avenue of the Americas JU 2-1500
(6th Ave. at 43rd St.) N.Y. 36, N.Y.

be purchased locally. The sheets are available in any rectangular size desired up to 18" x 21".

FLYBACK CHECKER KIT

Allied Radio Corporation, 100 N. Western Ave., Chicago 80, Ill., has just released a new flyback checker kit, another in the firm's "Knight" kit line of test instruments for technicians.

The new instrument permits instant



and highly accurate checking of all types of standard horizontal output transformers and deflection yokes as well as linearity controls. The checker will positively indicate shorted turns for any coil with a "Q" greater than 1 and an inductance between .003 henry and 2 henrys. The instrument will determine the continuity of any circuit with a resistance between 0 ohm and .5 megohm. It uses a 6S4A tube in a pulsed oscillator circuit.

Designated as Stock No. 83 Y 118, the new instrument comes complete with all parts, test leads, solder, and wire. Clearly presented diagrams and detailed schematics make assembly easy. The checker operates from 110-120 volts, 50-60 cycle a.c.

TEN-TURN POTS

Fairchild Controls Corporation, 225 Park Ave., Hicksville, N. Y., has announced the availability of two new ten-turn precision potentiometers, the type 907 phenolic and the type 908 metal.

Both units have a diameter of 7/8" with 3600 degree electrical rotation. Resistance ranges are from 100 to 100,000 ohms in both models. The type 907 has a linearity range of .1% to .5% while the type 908 has a linearity range of .05% to .25%. They are rated at 2 and 2 1/2 watts respectively, at 40 degrees C.

Information on these new pots is available from the Components Division at either 6111 E. Washington Blvd., Los Angeles 22, Calif., or the Hicksville address.

PORTABLE DICTATION MACHINE

Peirce Dictation Systems, Inc., 5900 Northwest Highway, Chicago, Ill., has developed a new book-size 4 1/2 pound dictation machine that operates on two self-contained batteries as well as on office, car, and home current.

Unlike miniature recording ma-

ROUND, SQUARE, KEY and "D" OPENINGS QUICKLY MADE with Greenlee Radio Chassis Punches

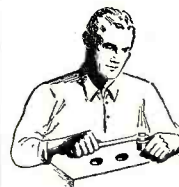
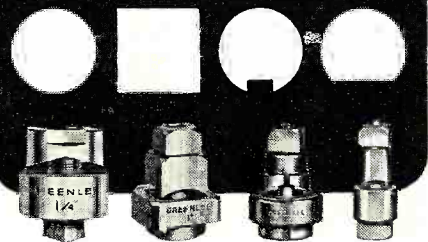

Save hours of hard, tedious work... cut accurate holes in chassis for sockets, plugs, controls, meters, panel lights, etc. with GREENLEE Punches. In 1-1/2 minutes or less make a smooth hole in metal, bakelite or hard rubber. Easy to operate... simply turn with ordinary wrench. Wide range of sizes. Write for details. Greenlee Tool Co., 1881 Columbia Avenue, Rockford, Ill.



TOOLS FOR CRAFTSMEN

GREENLEE

**COYNE
QUALITY
TRAINING
AT LOWEST
COST**

**COYNE
TRAINS YOU
IN SPARE TIME
AT HOME**

**TELEVISION
RADIO-COLOR TV**

Only from famous COYNE do you get this modern up-to-the minute TV Home Training. Easy to follow instructions—fully illustrated with 2150 photos and diagrams. Not an old Radio Course with Television tacked on. Includes UHF and COLOR TV. Personal guidance by Coyne Staff. *Practical Job Guides* to help you EARN MONEY QUICKLY IN A TV-RADIO SALES AND SERVICE BUSINESS—part time or full time. COSTS MUCH LESS—pay only for training—no costly "put together kits."

SEND COUPON FOR FREE BOOK

SEND COUPON BELOW for Free Book and full details including EASY PAYMENT PLAN, NO COST OR OBLIGATION—NO SALESMAN WILL CALL.



B. W. COOKE, Pres. **COYNE** FOUNDED 1899
ELECTRICAL SCHOOL

A TECHNICAL TRADE INSTITUTE OPERATED NOT FOR PROFIT
500 S. Paulina Dept. 37-HT5 Chicago 12, Illinois

COYNE ELECTRICAL SCHOOL
Television Home Training Div.
500 S. Paulina St., Chicago 12, Ill., Dept. 37-HT5

Send FREE BOOK and details of your Television Home Training offer.

Name _____

Address _____

City _____ State _____

chines, the new battery-powered "Secretary" is a complete dictation unit. It incorporates instant playback and review at any dictation point as often as desired, full context listening with

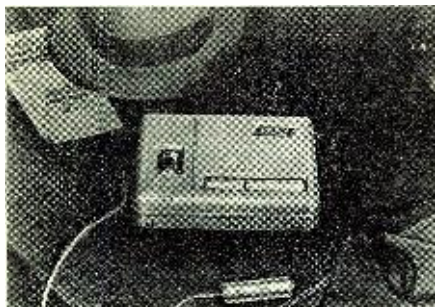

end-of-letter and instruction marking on index slip. The magnetic belt dictation medium holds fifteen minutes of dictation and is transcribed on standard office units.

The circuit incorporates printed circuitry and includes complete input-output volume control. A dynamic, close-talking microphone insures clear voice pickup and safeguards privacy.

Inquiries regarding the new dictation machine should be addressed to S. J. Kalow in care of the company.

LIGHTWEIGHT FERRITE CORE

Allen-Bradley Company, 136 W. Greenfield Ave., Milwaukee 4, Wis., has developed a new method of molding full-round ferrite deflection yoke cores which has resulted in still another improvement—a flared ferrite core for use with the new 110 degree picture tubes.

The new flared yokes make possible a weight reduction of 30 per-cent over conventional cylindrical cores heretofore used for these new picture tubes. The reduction in material comes from shaping the outer surface so that the cross section is approximately uniform from top to bottom.

VOLTAGE-REGULATED SUPPLY

Precision Apparatus Co., Inc., 70-31 84th St., Glendale 27, Long Island, N. Y., is now offering the Model 230



voltage-regulated multi-bias supply as an accessory instrument designed for single and multiple bias substitution

March, 1957

REMEMBER...
when you
SPECIFY STANCOR

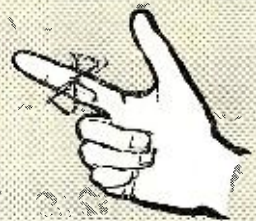

**YOU WON'T HAVE
TO DO THIS...**

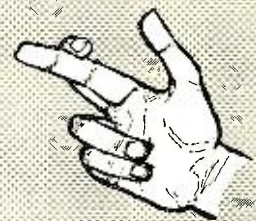

**because
YOUR CUSTOMERS
WILL DO THIS**



**STANCOR
TRANSFORMERS**
are available at better
distributors everywhere

free!

The latest up-to-date Stancor TV Transformer Replacement Guide and Catalog—from your distributor or write us for your copy.



CHICAGO STANDARD TRANSFORMER CORPORATION

3505 ADDISON STREET • CHICAGO 18, ILLINOIS

Export Sales: Roburn Agencies, Inc., 431 Greenwich St., New York 13, N.Y.

**THE
NEW**

**No-Noise
TUNER-TONIC**

Volume Control and Contact Restorer with Perma-Film



2 oz. bottle, Net to servicemen. **1.00**

Cleans, lubricates, protects... not a carbon-tet solution. Still available in the new 6 oz. spray can. Net to servicemen—\$2.25



Also available in 8 oz. bottles and quart cans. At your nearest distributor.

with **PERMA-FILM**

Cleans, lubricates, restores all tuners including wafer type. Won't change or affect capacities, inductance or resistance. Won't harm insulations or precious metals, nor attack plastics. For television, radio and FM. Eliminates all noise, oxidation and dirt indefinitely. Non-toxic, non-inflammatory, insures trouble-free performance. Extra economical because a small amount does the job! **Net to servicemen. \$3.25**



ELECTRONIC CHEMICAL CORP.

813 Communipaw Avenue

Jersey City 4, N. J.

Complete Electrical Repair Training

... FOR GOOD PAY,
GREATER OPPORTUNITIES
IN UNCROWDED FIELDS



The electrical field is growing—fast. The average small home has at least a dozen motorized appliances—and many others that are not. Almost every industry uses motors by the thousand. The expert who can keep this equipment in tip top shape is a valuable man in this Electrical Age. What's more, the work is a "natural" for radio-TV men. It expands your services—helps you make better profits—keeps you a big step ahead of competition.

Now! LEARN ELECTRIC MOTOR REPAIR (INCLUDING REWINDING)

① This famous 560-page Rinehart **ELECTRIC MOTOR REPAIR** book explains every step of the work both by text and by over 900 how-to-do-it pictures. Designed for home training, it is a complete service and rewinding guide to practically any electric motor—from those used in home appliances to big industrial motors, generators and motor controls.

A well-paid modern profession!

When a certain motor comes for repair, just look it up. Quick guides show how to handle specific jobs. Right up and down the line, **ELECTRIC MOTOR REPAIR** explains trouble-shooting, repair and rewinding so you can clearly understand it—even without a lot of previous electrical training. Price \$6.95. See Money-Saving offer. Money-back guarantee.

LEARN ELECTRIC APPLIANCE REPAIR (Earn as You Learn)

② This 370-page Rinehart **ELECTRICAL APPLIANCE SERVICE MANUAL** brings you specific repair instructions for practically every appliance used in modern homes. Even includes re-finishing methods. Handy charts help you locate troubles fast. Simple test instruments, tools, wiring problems and necessary electrical principles are fully described. Gives you the "know how" to earn spare-time money—to add a profitable sideline to your radio-TV service—or to build a full-time appliance repair business. Price \$5.00 separately—or see money-saving offer in coupon.

Now Low Price ... You Save \$1.00

If written in "lesson" form and sold as a "course" you'd regard these two great books as a bargain at \$10.00 or more. Together, they form a 930-page electrical repair library that makes it easy to train for broader, better-paying service jobs.

Under this offer, you save \$1.00 on the regular price of the books. And you can pay in easy installments while you use them!

— PRACTICE 10 DAYS FREE! —

Dept. RN-37, RINEHART & CO., INC.
232 Madison Ave., New York 16, N. Y.

Send books indicated for 10-day FREE EXAMINATION. I will then either remit price indicated or return books and owe nothing.

- ELECTRIC MOTOR REPAIR (\$6.95)
- ELECTRICAL APPLIANCE SERVICE MANUAL (\$5.00)
- MONEY-SAVING OFFER—Save \$1.00

Send both books at special price of only \$10.95 plus postage (regular price \$11.95). Payable at rate \$4.95 after 10 days if you decide to keep books and \$9.00 per month for 2 months. (SAVE! Remit price with order and we pay postage. Same 10 day return privilege with money refunded.)

Name

Address

City, Zone, State

in color and monochrome TV alignment.

The instrument provides four simultaneous bias voltages to substitute for a.v.c., a.g.c., chroma, etc. Each output is individually adjustable and well filtered from a voltage-regulated source. Three of the controls are variable from 0 to —15 volts negative; the fourth control is variable from 0 to —150 negative volts.

"WRAP-AROUND" RECTIFIER

Federal Telephone and Radio Company, 100 Kingsland Road, Clifton, N. J., is now in production on a new type of 65 ma. selenium rectifier which has a metal "wrap-around" design said to offer major advantages over conventional, equivalent-rated designs.

The rectifier has its individual cells placed flat against each other like pages in a book instead of being placed on a center shaft with an air space between cells. With the new design, center mounting shafts are eliminated giving more rugged construction and greater protection against contamination by

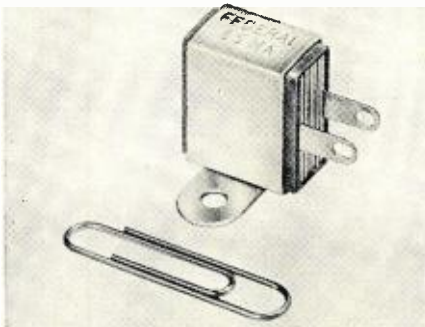

moisture. The metal "wrap-around" provides thermal coupling to the chassis, which acts as a heat sink so that air cooling is not necessary. This permits flexibility of mounting, an important consideration in portable equipment where space is at a premium. This feature also protects the rectifier from physical damage and permits it to be easily screw-mounted, riveted, or eyeleted.

Full details on this new rectifier are available from the sales department of the firm's Components Division.

NEW "TELECHECK"

Telematic Industries, Inc., 16 Howard Ave., Brooklyn 21, N. Y., is now in production on a new model "Telecheck" which has been revised to accommodate the new 8" 8AXP4 tube, in a flexible setup permitting various combinations of the tube, yoke, case, etc.

This service instrument is a CRT tube and yoke assembly permitting quick and accurate checks of tube and



yoke faults in the home or on the bench. The unit consists of an 8AXP4 tube, requiring no ion trap, which can be used with all sets either in the kit or by direct substitution; a universal yoke for use with all popular sets, wired and fused to eliminate possible damage to the set; universal service extension leads for the CRT anode and yoke for use with the unit or for general service work; a plastic mask and yoke support; and a lightweight case.

ANTI-CORONA SOCKET

Sylvania Electric Products Inc., Warren, Pa., has developed a 9-pin electronic tube socket that protects against high-voltage corona in miniaturized equipment such as portable television receivers.

The over-all height of the socket is 1 $\frac{1}{16}$ " with a body diameter of 1 $\frac{3}{4}$ ".

—30—

JAMESTOWN FESTIVAL CARD

THE Richmond (Virginia) Amateur Radio Club is offering an attractive new certificate to be known as VA-JF. This certificate is being offered in connection with the 1957 Jamestown Festival.

The year-long Festival is expected to attract many tourists. It will open during April at Jamestown, near Williamsburg, to commemorate the 350th Anniversary of the first permanent English settlement in America in 1607.

The requirements for this award are the submission of proof, by QSL's or otherwise, of having had 25 two-way contacts with different stations in the Commonwealth of Virginia during the period January 1, 1957, through December 31, 1957.

Both c.w. or phone are acceptable and stickers for additional 25 contacts at a time, up to 125, will be issued.

Address QSL's to Richmond Amateur Radio Club, P. O. Box 1985, Richmond 16, Va. The QSL's and Certificate will be returned to the sender.

—30—

Watch for Our
New Title
Next Month

**RADIO
& TV NEWS**

Loran APN/4 Oscilloscope

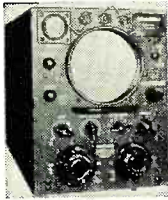

Easily converted for use on radio-TV Service Bench!

BRAND NEW

Completely Assembled Supplied with 5" Scope type 5CP1 and RCA 100 Kc. Crystal Unit

\$1495

I-95-M FIELD STRENGTH METER

Tunes 100 to 155 Mc. Made for Signal Corps. Like New

\$34.50

MN26Y BENDIX DIRECTION FINDER 150-325 Kc; 825-695 Kc; 3.4-7 Mc. Complete with tubes, motor.

\$26.95

BRAND NEW Used, like new, incl. tubes and dynamotor. **\$18.95**

BENDIX DIRECTION FINDER

12-tube remote control Navigation Direction Finder and communications receiver. 150 to 1500 Kc in 3 bands, 28 V. DC input. Ideal for commercial navigation on boats and planes. Complete installation comprises:

- MN-26-C Receiver, used, with 12 tubes **\$16.50**
- MN-26-C With 12 Tubes, BRAND NEW **\$24.95**
- MN-20-E Rotatable Loop **4.25**
- MN-52 Azimuth Control Box **2.95**

All necessary accessories for above in stock. **TS-16/APN TEST SET, BRAND NEW, complete with all cables. \$12.95**

JUST ARRIVED!

MODEL 0A0-2 NAVAL RADIO TEST EQUIPMENT FREQUENCY METER 110 V 60 cycles AC. 105 to 127 Mc. Mfd by LIEBEL-FLAR-SHEIM CO. BRAND NEW, Export Packed **\$44.50**

BC-906 FREQ. METER—SPECIAL!



Cavity type, 145 to 235 Mc. BRAND NEW in original factory packing, complete with antenna. Manual included. **OUR LOW PRICE \$8.88**

BC-221 FREQ. METER. \$129.50

BC-221 FREQ. METER CASE

Aluminum Case for BC-221 or TS-164 Freq. Meters. Shock Mounted. BRAND NEW. Original 1000 Kc Crystal for BC-221. BRAND NEW **\$8.45**

TG-5-B TELEGRAPH SET

Made for USA Army Signal Corps. A dandy little field set for 2-way communication. Sturdy metal container, 6 3/4" x 4 3/4" x 4", with hinged covers, complete with telegraph key and headset. BRAND NEW, in carrying case with shoulder strap. **\$9.95** Used, exc. Cond. **\$7.95**

TG-10 KEYS. Complete with all Tubes. **\$21.95**

110 V. 60 cy

BRAND NEW SELSYNS

Operates from 57 1/2 volts, 400 cycles. New tested. Conversion diagram for 110 volts AC included. 2J1G1 Selsyn Control Transformer. **\$2.95**

2J1H1 Selsyn Differential Generator. Each **\$.50c**

DYNAMOTOR VALUES!

Type	Input	Output	Used	BRAND NEW
DA-19-A	28V 11A	400V .400A	\$4.99	\$6.95
DM-28	28V	224V .07A	2.95	4.95
DM-32A	28V 1.1A	250V .05A	2.95	5.95
DM-33A	28V 5A	575V .16A	1.95	3.95
	28V 7A	540V .25A	1.95	3.95
DM-34D	12V 2A	220V .080A	4.25	5.50
DM-37	25.5V 9.2A	625V .225A	5.95	8.95
DM-40	14V 3.4A	172V .138A	1.75	3.45
DM-53A	28V 1.4A	220V .080A	3.95	5.95
DM-64A	12V 5.1A	275V .150A	3.95	7.95
PE-73C	28V 20A	1000V .350A	8.50	11.50
PE-86	28V 1.25A	250V .050A	2.95	5.24
PE-103	6V	500V .160A		
	12V	500V .160A	19.50	34.50
PE-186	28V 11A	400V .400A		6.95



2 VOLT BATTERY "PACKAGE"

- 1—2V. 20 Amp. Hr. Willard Storage Battery **\$2.45**
 - 1—2V. 7 prong Synchronous Plug-in Vibrator **1.49**
 - 1—Quart Bottle Electrolyte (for 2 cells) **1.45**
- ALL BRAND NEW! Combination Price... \$4.99**

Willard 6-Volt Midget Storage Battery 3 Amp. Hour. BRAND NEW. 3 5/8" x 1-13/16" x 2 3/8". Uses Standard Electrolyte. **Only \$2.22**

ASB-5 RECEIVER FOR 420 Mc BAND!

As featured in "CQ" for October 1956. Easily converted, makes a marvelous receiver for 420 Mc band, with RF amplifier! Supplied complete with all tubes. **OUR LOW PRICE. \$1.29**

\$1495

Tuning Knob for ASB-5 Receiver. **\$1.29**
ASB-5 INDICATOR **\$16.95**

Ham Special! Famous BC-645 XMITTER-RECEIVER



With MANUAL for Easy Conversion to CITIZENS' BAND!

Makes wonderful mobile rig for 420-500 Mc. Easy to convert for phone or CW 2-way communication. This swell rig originally cost over \$1000—yours for practically a song! You get it all, in original factory carton, BRAND NEW, complete with 17 tubes, less power supply. Conversion Instructions Included. **\$29.50**

Shpg. wt. 25 lbs. **\$29.50**

PE-101C DYNAMOTOR for BC-645, has 12-24V input (easy to convert for 6V Battery operation) **\$7.95**

UHF ANTENNA ASSEMBLY, for BC-645. Complete set of 10 Plugs for BC-645 **\$5.50**

CONTROL BOX for above. **\$2.25**
SHOCK MOUNT for above. **1.25**
CONVERSION BOOKLET. Instructions for most useful surplus rigs. **\$2.50**

SCR-522 2-METER RIG!

Terrific buy! VHF Transmitter-receiver, complete with all components. 100-156 Mc. 4 channels. Xtal-controlled, Amplitude modulated voice. They're going fast! Excellent condition. **SCR-522 Transmitter-Receiver, complete with all 18 tubes. \$33.33**

COMBINATION. . . . Special \$33.33

Receiver Only, with all tubes. \$19.50
Transmitter Only, with all tubes. \$22.25

ARC-5/T-23 TRANSMITTER

100-156 Mc Includes 2-832A, 2-1625 Tubes. **\$19.95**

SPECIAL OFFER! Limited quantity ARC-5/T23 xmitters. BRAND NEW, less tubes. **\$7.95**
Excellent Used, less tubes. **\$5.95**

ARC-5 MARINE RECEIVER-TRANSMITTER

Navy Type Comm. Receiver 1.5 to 3 Mc **\$16.95**

BRAND NEW with 6 tubes. **\$12.45**

AN/ARR-2 RECEIVER

BRAND NEW — A Terrific Value! Tuning Range 234 to 258 Mc. Tubes: 7-9001, 3-8AK5, 1-12A6. Only a few at this low price! Complete **\$8.88**

With 2 V 1.6A Dynamotor, complete **\$12.95**

110 VOLT AC POWER SUPPLY KIT for above. **\$7.95**

NAVY RECEIVER TYPE ARB

Four Band. 195 to 9050 kc. Low Arb. Ship, Broadcast 40 to 80 meters. Includes tubes and dynamotor, for 24 volt operation. Easily converted for 110 V., 12 V., or 6 V. Schematic Included. Excellent Condition. Overall: 8 1/4" x 7 1/4" x 15 1/4". Wt. 30 lbs. **COMPLETE WITH ALL TUBES, Special. \$21.50**

LORAN APN-4 FINE QUALITY NAVIGATIONAL EQUIPMENT

Determine exact geographic position of your boat or plane! Complete, BRAND NEW, installation consists of: 1D-6B/APN Indicator; R-9B/APN-4 Receiver; PE-206 Inverter; Set of Plugs; Invisor for Indicator; Operation manual; Brand New, Export packed. **COMPLETE. \$129.50**

SPECIAL APN-9A LORAN Receiver Indicator, less tubes, NEW (demilitarized) **\$29.50**

WRITE FOR FREE CATALOG!

Please include 25% Deposit with order—Balance C.O.D. MINIMUM ORDER \$3.00. All shipments F.O.B. Our Warehouse N.Y.C.

G & G Radio Supply Co.

Dept. N-3
51 Vesey St., New York 7, N. Y., CO 7-4605
Branch: 5009 N. Neva Ave., Chicago 31, Ill.

R24-ARC/5 NAVY TYPE

(Similar to BC-946)

BROADCAST RECEIVER

520 to 1500 Kc. 6 tubes: 3-12SK7, 12SK7, 12A6, 12K8. For dynamotor operation, Easily converted to 110 or 32 Volt. 2-IF stages, 3-gang tuning cond. Complete with all tubes, in original sealed carton. **\$19.95**



BRAND NEW. **\$19.95**

BC-457 TRANSMITTER—4-5.3 Mc. complete with all tubes and crystal. **\$7.88**

BC-458 TRANSMITTER—5.3 to 7 Mc. Complete with all tubes and crystal. **\$7.88**

BC-459 TRANSMITTER—7-9.1 Mc. complete with all tubes and crystal. **\$11.95**

ARC-5/T-23 TRANSMITTER—3 to 4 Mc. BRAND NEW complete with all tubes & crystal. **\$8.88**

110 VOLT AC POWER SUPPLY KIT

For All 274-N and ARC-5 Receivers

Can be assembled quickly and easily, on pre-drilled chassis. Plugs into the rear of any model 274-N receiver and delivers 24 volts as well as "B" voltage. Complete kit of parts with metal case, instructions. **\$7.95**

SPLINED TUNING KNOB for 274-N and ARC-5 RECEIVERS. Fits BC-453, BC-454 and 49c others. **Only. \$4.95**

SCR-274 COMMAND EQUIPMENT

ALL COMPLETE WITH TUBES Excellent Brand Type Description Used New

BC-453 Receiver 100-550 KC. **\$9.95 \$11.95 \$14.95**

BC-454 Receiver 3-6 Mc. **7.49 8.29 11.95**

BC-455 Receiver 6-9 Mc. **5.25 7.95 9.95**

BC-456 Modulator **2.24 2.75 4.24**

BC-450 3-Receiver Control Box **1.49 1.95**

BC-451 Transmitter Control Box **1.25 1.49**

BC-696 Xmt 3-4-Mc (like new) **6.95 8.88**

BRAND NEW SPECIAL PURPOSE TUBES

in Original Individual Packing

JAN CRP-730A MAGNETRON, Raytheon. \$3.45

Type	Each	Lots of 12	Lots of 100
6J6W	\$.45	\$5.15	\$41.00
1625	.16	1.75	13.50
1626	.16	1.75	13.50
826	.44	4.95	39.50
21724B	.35	3.95	29.50

NEW! Cathode Ray Tubes NEW!

3CP1 **\$.88** 5BP4 **\$2.22**
3FP1 **1.38** 5CP1 **1.75**
5BP1 **2.22** 5LP7 **1.88**

BUBBLE SEXTANT

Made for U. S. Armed Forces by AGFA ANSCO. Actually worth \$150 or more! Has illuminated averaging disc for nighttime use. Complete with carry-ing case. **Only \$9.95**



DYNAMIC HANDMIKE, with "Press-to-talk" Switch, cord and plug—BRAND NEW, only. **\$2.95**

DYNAMIC HEADPHONES, 600-ohm impedance, with large earphone cushions, cord and phone plug. BRAND NEW, special. **\$2.95**

DYNAMIC Headphone with Dynamic Mike. \$3.95

BRAND NEW. \$3.95

HI-FI DYNAMIC HEADSET with Cushions Freq. Range: 40-14000 GFS. No Distortion. **\$5.95**

MICROPHONES

Model	Description	Used	BRAND NEW
T-7	Carbon Hand Mike	\$.45	\$7.95
T-30	Carbon Throat Mike	.33	.69
T-45	Navy Lip Mike		.99
R5-38	Navy Type	2.45	4.95
T-24	Carbon Mike		3.95
TS-9	Handset		4.95

HEADPHONES

Model	Description	Used	BRAND NEW
HS-23	High Impedance	\$2.25	\$4.35
HS-33	Low Impedance	1.99	4.65
HS-30	Low Imp. (featherwt.)	1.49	2.25
H-16/U	High Imp. (2 units)	2.75	7.95
CD-307A	Cords, with PL55 plug and JK2 Jack.		.99

BC-442 ANTENNA RELAY

Wonderful Value! Consists of 3/4 amp 250 RF Ammeter (antenna current indicator), 0-10 scale, Transmitter-Receiver Switching relay, in aluminum case with associated components. BRAND NEW. **\$2.24**



AMERICA'S FINEST VALUES IN "LOW COST" HIGH FIDELITY

ECONOMY 20 WATT AMPLIFIER \$22.95

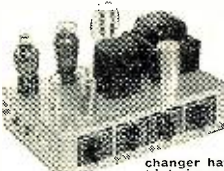

\$24.95
 Push-Pull 6L6 Output Tubes
 Response 30-15,000 cps
 Bass and Treble Tone Controls
 Input for Xtal or Dynamic Mike
 Input for Xtal or V. R. Phono

A tremendous High Fidelity amplifier value. Response 30 to 15,000 cps. Electronic bass and treble boost by separate tone controls. Use this amplifier with any record changer having crystal or variable reluctance cartridge, radio tuner or high impedance crystal or dynamic microphone. 20-watts power output. Use with any 8-ohm speaker. Chassis size 7 3/8" x 10 1/2" x 7 1/2" high. Complete with tubes: 2-6L6, 2-6C4, 12AX7 and 5U4G. This is a terrific value. A ready to use High Fidelity amplifier at less than the cost of a kit. Model HF-21, 20-watt Hi-Fi amplifier. Sale Price \$24.95.

NEW IMPORTED MONARCH HIGH FIDELITY AUTOMATIC CHANGER

With **RONETTE #222 Hi-Fi turn-over crystal cartridge with separate sapphire needles.** **SALE PRICE \$27.95**

Monarch Model U48 new imported high fidelity 4-speed automatic record changer, size 10 7/8" x 12 3/4". Plays 7", 10" and 12" records automatically. Intermixes records of the same speed in any order. Features a 4-pole high fidelity motor eliminating rumble and wow. 9" turntable with high fidelity rubber molded cushion dynamically balanced. Counter balance tone arm with adjustable weight to any desired cartridge—adaptable for G.E. cartridge. Ship. wt. 15 lbs. Model U48 Monarch automatic record changer with Ronette No. 222 crystal cartridge—Sale Price \$27.95. With Goldring No. 500 Var. Rel. cartridge—Sale Price \$29.95. 45 rpm spindle, \$1.88 extra.

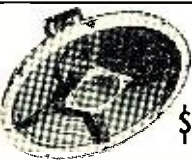

12" COAXIAL PM SPEAKER RESPONSE 25-17,000 CPS

\$9.95
 Model 12X3Y, new 1957 12" Coaxial PM Speaker, has high efficiency 12" woofer with Alnico V magnet and coaxially suspended 3 1/2" Alnico V tweeter. Built-in variable brilliance control on an 18" lead for remote control of the tweeter volume. 10-watts, response 25 to 17,000 cps. Ship. wt. 5 lbs. Stock No. 12X3Y, 12" coaxial PM Speaker. Sale Price \$9.95.

SPECIAL MONEY SAVING COMBINATION PACKAGE DEAL

Model HF-21, 20-watt Hi-Fi Amplifier. Model U48, MONARCH Hi-Fi Automatic Changer, and Model 12X3Y, 12" Coaxial PM Speaker as described above. **SPECIAL PRICE \$59.95**

3 - 1957 MODEL Hi-Fi SPEAKERS

• COMPLETE SYSTEMS WITH 4 SPEAKERS
 • ACOUSTICALLY LINED ENCLOSURES
 The new 1957 Hollywood, 4 speaker high fidelity speaker systems are expressly designed to give realistic reproduction from your Hi-Fi amplifier or FM-AM radio. Juke box bass response with brilliant, middle and high range response. All 3 models have genuine L-C crossover networks and variable brilliance controls. Only 2 wires to connect to the 4 or 8 ohm tap on your Hi-Fi amplifier. A fine speaker system to use with either Imperial 20, 30 and 30 high fidelity amplifiers and all FM-AM chassis in our Radio & TV News offerings. Adjusting the twin tone controls on our Imperial amplifiers control on the brilliance control on the Hollywood speaker systems you can have fidelity of your own personal taste. All 3 Hollywood models are housed in the same fine cabinet, 35" high, 19" front to back, 25" wide. Specify cabinet finish when ordering, otherwise we will ship mahogany finish. Take \$3.00 discount when you order with any of the Imperial amplifiers or Espey FM-AM chassis offered in this 3 page ad.

Model H-4H, Hollywood 4 speaker high fidelity speaker system, 20 watts, response 20 to 17,500 cps. Choice of blond or mahogany finish enclosure. Features 12" General Electric 6.8 oz. Alnico V magnet, aluminum voice coil woofer, plus 6" mid-range and 2-5" tweeters. Built-in variable brilliance L-C crossover network. Model H-4H, Ship. wt. 55 lbs. Price \$39.95.

Model Y-4Y, Hollywood 4 speaker, high fidelity speaker system, 25 watts, response from 20 to 17,500 cps. Choice of blond or mahogany finish enclosure. Features 12" General Electric 14 oz. Alnico V magnet, aluminum voice coil woofer, plus 6" mid-range and 2-5" tweeters. Built-in variable brilliance L-C crossover network. Model Y-4Y, Ship. wt. 55 lbs. Sale price, \$44.95.

Model Z-4Z, Hollywood 4 speaker, high fidelity speaker system, 25 watts, response from 18 to 17,500 cps. Choice of blond or mahogany finish enclosure. Features a 15", 21 1/2 oz. Alnico V Utah heavy duty woofer, plus 6" mid-range and 2-5" tweeters. Built-in variable brilliance, L-C crossover network. Model Z-4Z, Ship. wt. 57 lbs. Sale price, \$49.95.

IMPERIAL 30 WATT AMPLIFIER \$29.95

NEW 1957 MODEL
 Push-Pull 6L6 Output Tubes
 Response 15-20,000 GPS
 Bass and Treble Tone Controls
 Compensated Gain for G.E. Cart.
 Input for Xtal or Dynamic Mike

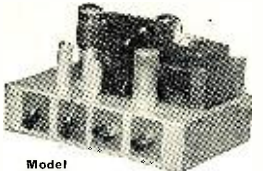

With CU-14Y, 12" Coax Speaker . \$39.95
 With P15-GR, 15" Coax Speaker . \$49.95
 With Imperial IV Speaker System . \$46.95
 With Imperial VI \$55.95
 With HF-33GE \$76.95
 New 1957 model 7 tube Imperial 30 watt Hi-Fidelity amplifier, a \$100.00 list value for only \$29.95. Features a heavy 4 lb., specially wound high fidelity output transformer with 15% inverse feed-back; push-pull 6L6 output tubes and frequency response from 15 to 20,000 cps. Matches 8 or 16 ohm speakers. You can center your entire custom music system around this low cost 30 watt amplifier. This Imperial 30, 30 watt amplifier may be used with any radio tuner or record player. It will drive any speaker system that you may have. Use from one to ten 8" speakers or any 12" or 15" coaxial speaker or any 3-way speaker system. Tone compensated input for either a crystal phono pickup or a General Electric variable reluctance pickup. Also, has input for crystal or high impedance dynamic microphone, 4 controls are mike gain, phono gain, treble tone and bass boost tone control. This amplifier weighs 21 lbs. net. Full size transformer components would cost you up to \$15.00 if purchased separately. Gold color chassis is 12 1/2" x 7 3/4" x 7 1/4" high. Complete with tubes: 6AT6, 2AU7, 6C4, 2-6L6A, plus 5U4G rectifier. Stock No. IMP-30, 30 watt Imperial High-Fidelity amplifier complete with tubes and diagram. Ship. wt. 23 lbs., Sale price only \$29.95.

NEW IMPERIAL 24 WATT AMPLIFIER \$39.95

PUSH-PULL EL-34 ENGLISH MADE MULLARD OUTPUT TUBES
WILLIAMSON TYPE CIRCUIT
RESPONSE 15-20,000 CPS

With CU-14Y, 12" Coax Speaker . \$49.95
 With P15-GR, 15" Coax Speaker . \$59.95
 With Imperial IV Speaker System . \$56.95
 With SP12125CR . \$65.95. With HF-33GE . \$86.95. Model IMP-34X
 New, 1957 model Imperial 34X, 24 watt high fidelity amplifier for the audio enthusiast who wants McGee's finest amplifier. This amplifier features push-pull Telefunken or EL-34 English made Mullard output tubes in a Williamson circuit. Heavy duty 6 lb. specially wound Williamson type ultra-linear output transformer in potted case has a response from 15 to 20,000 cps. Matches 8 or 16 ohm speakers. Amplifier has input for crystal pickup and built-in pre-amplifier for the popular General Electric and Goldring variable reluctance cartridges; as well as input for crystal or high impedance dynamic microphones. 4 controls are microphone gain, phono gain and separate variable treble and bass boost tone control with on-off switch. Chassis size: 12 1/2" x 7 3/4" x 7 1/4" high. Complete with tubes, diagram, Model IMP-34X, 24 watt high fidelity amplifier, ideal for use with any of our high fidelity coaxial or multiple speaker systems. Ship. wt. 26 lbs. Sale price, \$39.95.

McGEE'S NEW 1957 MODEL 25 WATT 12" COAXIAL SPEAKER

- ★ 14 1/2 oz. G.E. 12" WOOFER—
- ★ 3 1/2" COAXIALLY SUSPENDED TWEETER—
- ★ BUILT-IN CROSSOVER—
- ★ ALUMINUM VOICE COIL WOOFER—

\$18.95
 McGee's new 1957 model, GE-120XT, 12" 25 watt high fidelity coaxial PM speaker. No frills or dummy pot cover, it's all speaker value. Features a General Electric 12", 14 1/2 oz. Alnico V woofer with aluminum voice coil and exponential, molded seam built-in crossover network. Model IMP-34X, 24 watt high fidelity amplifier, ideal for use with any of our high fidelity coaxial or multiple speaker systems. Ship. wt. 8 lbs. Stock No. GE-120XT, McGee Sale price, \$18.95. New 1957 model, 20 watt deluxe 12" coaxial PM speaker. Only 2 wires to connect to any 8 ohm Hi-Fi radio or amplifier. Features an aluminum voice coil high fidelity speaker to any 8 ohm amplifier. Ship. wt. 8 lbs. Stock No. GE-100XT, 12" coaxial PM speaker. Ship. wt. 8 lbs. Sale price, \$14.95.

TREMENDOUS McGEE VALUE NEW 1957 HI-FI SPEAKER SYSTEMS ON BAFFLE BOARDS

Model B-125, high fidelity 20-watt, 5-way speaker system, mounted on an 18" square baffle board. Has 12" G.E. woofer, 2-4x6" mid-range speakers, plus a 4" high-range and 3" tweeter; all with Alnico V magnets. Built-in LC crossover network with variable brilliance control. Ship. wt. 11 lbs. Stock No. B-125, 5-way, 20-watt Hi-Fi speaker system. AUDIOPHILE VALUE \$30.00. **SALE PRICE \$18.95**

Model B-236, high fidelity 24-watt, 4-way speaker system, mounted on a 24" square baffle board. Has 12" 9-oz. woofer, a new high fidelity extended range 6x9" speaker, plus 2-5" tweeters; all with Alnico V magnets. Built-in LC crossover network with variable brilliance and presence controls. Ship. wt. 16 lbs. Stock No. B-236, 4-way, 24-watt Hi-Fi Speaker system. AUDIOPHILE VALUE \$49.95. **SALE PRICE \$27.95**

Model B-347, high fidelity 30-watt, 5-way speaker system, mounted on a 30" x 24" baffle board. Has 15" UTAH 21 1/2-oz. woofer, 2-new high fidelity extended range 6 x 9" speakers, plus 2-5" tweeters; all with Alnico V magnets. Built-in LC crossover network with variable brilliance and presence controls. Ship. wt. 22 lbs. Stock No. B-347, 5-way, 30-watt Hi-Fi speaker system. AUDIOPHILE VALUE \$59.95. **SALE PRICE \$39.95**

Mount these Hi-Fi speaker systems in your own cabinet or use for custom installation. 6.3 VDC is available. Ship. wt. 10 lbs. Stock No. NH3C, Sale Price \$17.95 each or two for \$34.00.

NEW IMPERIAL SPEAKER SYSTEMS

Imperial IV with 8" G.E. High Fidelity Speaker \$19.95
3-Way Imperial VI with 12" G.E. Speaker \$29.95

New 1957 Model IMPERIAL IV, High fidelity speaker system with General Electric 8" speaker. Housed in a high quality leatherette covered plywood cabinet, 13" x 24" long. Fully enclosed; covered on all sides except back. Use as an auxiliary speaker or with any high fidelity radio, amplifier or home music system. The IMPERIAL IV contains a General Electric 8" 1000 cps. Alnico V magnet, plus 5 1/2" PM for middle range and 3" tweeter for high range. Response 50 to 15,000 cps. Model IV Imperial \$19.95.
 1957 Model Imperial VI, 3-way speaker system. Baffle is of heavy wood, leatherette covered. Similar in appearance to the Imperial IV pictured above, except 4" taller and 1" deeper. Equipped with 3 matched speakers: A 12" G.E. Model 1203 with 9 oz. Alnico V magnet, plus 5 1/2" PM for middle range and 3" tweeter for high range. Connect to any high fidelity amplifier. (8 ohms impedance). Stock No. IMP-VI, Sale price, \$29.95. Ideal for use with HF-20 and IMP-30 amplifiers described above.

GENERAL PURPOSE AUTO-RADIO

SALE PRICE \$17.95
 Over \$49.95 List Value Radio, Nash model NH3C for Nash Rambler, manufactured by Motorola. Works on 6-volt storage battery, custom built Superheterodyne receiver, rating 4.3 Amp., 6.3 volts D.C., broadcast range 540-1600Kc, five tubes: 1 each 6BE6 Conv., 6BA6 Det. AVC-AF amplifier, 6AS5 audio output and 4 rectifier. With a 4x6" PM 3-ohm speaker. With some ingenuity, this set can be adapted to many other types of installation where a 6.3 VDC is available. Ship. wt. 10 lbs. Stock No. NH3C, Sale Price \$17.95 each or two for \$34.00.

22 TUBE ESPEY FM-AM HI-FI TUNER-AMPLIFIER SALE PRICE \$119.90

A REGULAR \$199.50 NET VALUE COMBINATION FOR \$119.90

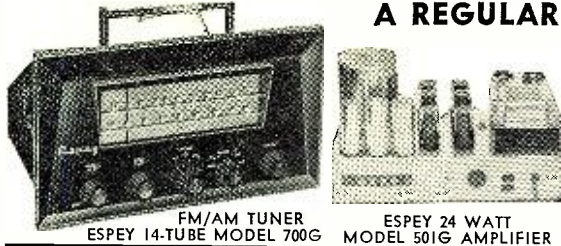

MODEL 700G
FM-AM TUNER
ONLY—
SALE PRICE **\$79.95**

MODEL 501G
AMPLIFIER **\$39.95**
If Ordered
with Tuner
\$49.95 SEPARATE

McGee offers you both the regular \$119.50, 14 tube Deluxe FM-AM tuner and the \$79.50 value 8 tube audio amplifier for the special sale price of only \$119.90. The Model 700G Espey tuner has its own built-in power supply. Performance features are: Sensitivity 3mv on AM, 5 mv on FM for 30 db quieting. AM selectivity 10kc at 6 db. FM 240kc at 6db. Audio response flat from 20 cps to 20,000 cps, with less than 1/4 percent distortion with one volt audio output. Chassis is 14" long, 8 1/2" high and 10" deep. Features a one-piece molded, gold color plastic front which makes a custom installation both extremely attractive and easy at the same time. Full tuned RF stages-AFC on FM with defeating switch for easy FM tuning. Built-in preamplifier for GE or other popular variable reluctance cartridges. Three position equalizer switch for LP, AES or European records. Separate bass and treble tone controls with 23db boost. Chassis is equipped with AC outlet jacks, auxiliary input jacks for tape recorder, etc. Has built-in ferrite loop antenna for AM broadcast band and 300 ohm input for FM band. This fine quality FM-AM tuner is second to none. It has all of the features that you might expect of a tuner that would cost as much as \$200. All of the controls are on the front panel. This is a most desirable feature when the tuner is used in conjunction with a good audio amplifier, such as the 501G which was designed with no tone control or preamplifier circuit.

The Model 501G, 8 tube ultra linear high fidelity, 24 watt audio amplifier is made to match the 700G tuner. This amplifier is offered separately at the special sale price of \$49.95, but costs you only \$39.95 when purchased with the 700G Espey tuner. This amplifier features less than 1/2 percent distortion with high fidelity response from 10 cps to 20,000 cps. Hum level so low it can be detected by electrical instruments only. Chassis size, 12"x5"x8". Output tubes: 4-6V6GT in push-pull Williamson oriented iron core. 2-5V4G rectifiers. Has an 8 pound potted case output transformer with specially made grain-oriented iron core. 6SN7GT phase inverter and 2-5V4G rectifiers. Has an 8 pound potted case output transformer with specially made grain-oriented iron core. 6SN7GT phase inverter and 2-5V4G rectifiers. Has an 8 pound potted case output transformer with specially made grain-oriented iron core. Buy just the 700G FM-AM tuner at the special sale price of \$79.95, or buy both the 700G tuner and the matching 501G amplifier for \$119.90. Model 501G amplifier sale price, \$49.95 when purchased separately. Tuner shipping weight 20 lbs. Amplifier shipping wt. 22 lbs. See the special deals of the 700G-501G tuner-amplifier combination with record changer, etc. Has built-in for extra money saving values. Also, special discount on speakers and speaker systems when ordered with your Espey tuner and amplifier.

ESPEY DEAL-1A
Espey 700G-501G tuner with 24 watt amplifier plus VM-956 GE 3 speed VM on metal base—1 Mill Diamond Needle \$10.00 extra. Net **\$144.95**

ESPEY DEAL-2
Espey 700G-501G tuner with 24 watt amplifier plus new 456 Collaro changer equipped with a GE RPX-052A cartridge. Net **\$164.95**

ESPEY DEAL-3
Espey 700G-501G tuner with 24 watt amplifier plus Garrard RC-98 equipped with a GE RPX-052A cartridge. Net **\$194.95**

SPE MENDED
Order any of the following speakers with your Espey tuner and amplifier:
12" coaxial PM, C14Y—\$10.00 extra
15" coaxial PM, P15-CR—\$20.00 extra
Imperial IV system—\$15.00
Imperial V system—\$25.00
Norelco 9762-12" regularly \$59.50 at \$30.00 extra.
EV84-15W system—\$150.00 extra.



BUY YOUR AUTOMATIC CHANGER AT MCGEE AND SAVE

COLLARO 456 - \$34.50
Latest 1957 Model RC-456, Collaro 4 speed record changer. Plays all 4 speeds, 16, 33, 45 and 78 RPM both automatically and manually. Inter-mixes records of the same speed and shuts off after last record. Fast 6 second change cycle. Automatic disengagement of idler wheels eliminates flat spots that cause wow and flutter. All of the desirable features of the Model RC-522, plus 4 speed operation. Model RC-456 Collaro 4 speed automatic record changer, less cartridge, Sale price, \$34.50. RC-456 with G.E. variable reluctance cartridge with 3 mil sapphire and 1 mil diamond stylus, Sale price, \$46.95. Large spindle \$3.30 extra.

Webcor 1642-1, \$27.95
Webcor 1641-21 3 speed changer, less base with RPX-050 G.E. VR cartridge, \$27.95. No. 1914, large 45 RPM spindle for 1641 and 1642 Webcor changers, \$2.44 extra.
Webcor CR-1631-27, \$34.95
Webcor CR-1631-27, Hi-Fi chrome changer with 2-separate plug-in cartridge shells, less cartridge, no base, Sale price, \$34.95.
Webcor CR-1631-27, \$49.95
Webcor CR-1631-27, same as above and with G.E. RPX-052A cartridge with 1 mil diamond stylus, Sale price, \$49.95.
Webcor CR-1631-21, \$49.95
Webcor CR-1631-21, Hi-Fi chrome changer same as above except has one piece tone arm with RPX-052A Golden Treasure cartridge, 1 mil diamond stylus, Sale price \$47.95. No. 1915, large 45RPM spindle for 1631 series Webcor changer, \$2.44 extra. Precut mounting board for 1641 or 1631 series Webcor changer, \$1.96 extra.

New 1957 Garrard Model RC98 "crown 11," 3-speed super automatic changer, \$66.15
This model combines the greatest combination of Hi-Fi features ever found in an automatic changer. Model RC98 changer, less cartridge—\$66.15. With VR cartridge, 1 mil diamond and 3 mil sapphire needles, RPX-052A—\$82.10. Large 45 rpm, center spindle \$3.45 extra.
Popular RC88 "Triumph" model with most of the features of the 98. RC88, less cartridge—\$53.41. With RPX-052A cartridge as above—\$69.36.

GOLDRING V. R. CARTRIDGE WITH 2 SAPPHIRE STYLII \$5.95 WITH 1 MIL DIAMOND, 3 MIL SAPH. \$13.95

McGee offers the internationally famous Goldring variable reluctance phono cartridge, made in England throughout the world to those who want the finest and most accurate music reproduction from 33 1/3, 45 and 78 RPM high fidelity phono records. (Input gain and compensation similar to G.E. v.r. cartridge required.) Furnished as standard equipment with 1 mil diamond and 3 mil sapphire needles. These are the latest at McGee for \$5.95. For \$13.95 with a diamond 1 mil stylus. These are the latest production, individually cartoned turnover cartridge with mounting bracket. Fits tone No. 546 Goldring V.R. (Wilcox-Gay) cartridge, Net \$5.95. No. 0546-GS, Goldring V.R. (Wilcox-Gay) cartridge with diamond 1 mil stylus, \$13.95. 1 mil diamond stylus for Goldring V.R. cartridge, purchased separately, \$9.95.

8" NORELCO P14 \$7.95
Specially Priced at \$7.95 for this ad. Norelco imported from Holland 8" Hi-Fi PM Model 9770M—fine audio reproduction from 75 cps to 19,000 cps. Imp. 4 ohms. Flux density 11,000 Gauss. Powerful Alnico Magnet. A fine addition to your Hi-Fi speaker collection. 2 for \$15.00

12" NORELCO 9760 HI-FI SPEAKER \$19.95
Model 9760, 12" Norelco 20 watt extended range high fidelity PM speaker. Has a 15.8 oz. Ticonal magnet. Resonance frequency 40 to 20,000 cps. Made by North American Philips Co. of Holland. A single cone coaxial speaker with extra high frequency cone. 8 ohm voice coil. Resonance frequency 45 cps. Total flux density, 8000 gauss. Ideal for use with any Hi-Fi amplifier. Sale price, \$19.95.
Model 9762, 12" Norelco 20 watt extended range high fidelity PM speaker. Better quality than above, in that it has a 38 oz. Ticonal magnet, greater flux density of 11,000 gauss and a speaker mechanism built in the center of the large cone.
Model 9762, 12" Norelco Hi-Fi PM speaker, Sale price only \$39.95.

WRITE FOR MCGEE'S 88-PAGE 1957 CATALOG

NEW 8 TUBE 6 VOLT PUSH-BUTTON MODEL \$37.95
New model SH-78555-X, 8-tube, 6-volt universal mounting auto radio with push buttons and 6x9 speaker. Made for Hudson cars, but their compact construction lends them to underdash installation. Has push-pull 6AQ5 high-powered audio Stock No. SH-78555-X with 6x9 speaker—\$37.95. With 2-5x7 speakers—\$39.95; with 1-5x7 speaker—\$37.95. Specialty speaker size wanted. Section top cowl mounting antenna—\$2.29 extra.



McGee's Famous 12 AND 15 INCH COAXIAL P.M. HIGH FIDELITY SPEAKERS
\$12.95 \$23.95
12-inch Model CU-14Y 15-inch Model P15-CR
Model CU-14Y, 12" high fidelity coaxial PM speaker. Response from 30 to 17,500 cps. Full 6.8 oz. Alnico V magnet in the 12" woofer. Special coaxially suspended high frequency tweeter. Built-in crossover network. Only two wires to connect to your radio or amplifier. Matches 3.2 to 8 ohm output. Don't confuse this speaker with many cheap speakers that are offered for sale. This is a fine quality speaker. Stock No. CU-14Y. Sale price \$12.95 each, two for \$25.00.
Model P15-CR, 15" high fidelity coaxial PM speaker. Response down to 20 cps, and up to 17,500 cps. Full 21 1/2 oz. Alnico V magnet in the 15" woofer. Specially made coaxially suspended 5" high frequency tweeter. Built-in crossover network. Only two wires to connect. Matches 3.2 to 8 ohm output transformer. A regular \$62.50 list price. Model P15-CR. McGee's Sale Price, \$23.95.
McGee's new 15" Junior coaxial PM speaker, 15" woofer has 6.8 oz. Alnico V magnet. Specially suspended tweeter with crossover. Only two wires to connect to any 8 ohm radio or amplifier. Frequency response from 40 to 17,500 cps. Model No. P15-CR, 15" Junior coax PM speaker. Sale price, \$16.95.

FAMOUS STANDARD COIL CASCODE TUNERS

TV-2000 series Standard Coil cascode tuners complete with 6J6 and 6BK7 or 6BQ7 tubes. Thousands of TV sets use this famous tuner. Tuning 12 channels (2 thru 13) For 21 mc I.F. circuit. This tuner will give 2 to 1 better reception than the old pentode type. Many servicemen replace all older tuners with this cascode model. Available with either 27g or 41g shaft length. A tremendous purchase makes our low \$12.95 price possible. Specify shaft length desired. Stock No. TV-2000-3. Sale price 2 FOR \$25.00. \$12.95 each, 2 for \$25.00.
Matching knobs for Standard Coil tuners. Set No. SK-2 for fine tuning and channel selector. Set VCK-2, matching volume and contrast knobs. Either set only 59c a pair.

STANDARD COIL PENTODE TUNERS \$7.95

SC-948, Standard Coil, 21 mc Pentode tuner with 6BC5 or 6AG5 and 6J6 tubes. Popular 12 channel, 2 thru 13, used in millions of TV sets. Why spend time repairing an old tuner when it may be easier to just replace it. Shaft can be cut to desired length. Available with 27g, 31, 41g or 41 1/2" shaft. Specify length of shaft. Sale price, \$7.95 ea., 2 for \$15.00. Matched knob set 59c extra.

TWO-TUBE SARKES-TARZIAN TV TUNER WITH TUBES
No. TT-3A, 2 tube Sarkes-Tarzian 12 channel TV tuner for 21mc. Use with Arvin, Crosley, etc. Ideal for general replacement. 3 1/2" shaft. With tubes, \$7.95 each, 2 for \$15.00.
No. TT-2C, 2 tube Sarkes-Tarzian 41 mc Cascode tuner with tubes, 4 1/2" shaft. Smallest cascode tuner made. Popular in 21mc sets. \$7.95 each, 2 for \$15.00.
Either of the above tuners with 9" shaft, \$13.00 extra.
Type 3, 3 tube 21 mc Sarkes Tarzian tuner with tubes. Rotary switch type complete with 6C4, 6BH6 and 6AG5 tubes. Regular cost is several times our new low price of only \$4.95. Wired, ready to hook-up to video and sound I.F. strip. Use with either separate sound or inter-carrier. Built-in fine tuning. 27g shaft. Net, \$4.95.

RCA KRK-12 TV TUNER Brand New—with Tubes

SALE PRICE \$6.95
2 for \$13.00
RCA Model KRK-12, UHF-VHF TV tuner with tubes: 2-6B7A, 6AF4 and 6S4. A complete tuner with all 12 VHF strips, but with blank strips in the UHF positions. This tuner fits many RCA sets using 40 megacycle I.F.s. 27D302 also KOS-66, etc. Original tuner list was about \$50.00. We offer them new at about the value of the tubes. Ship. wt. 10 lbs. McGee's sale price, \$6.95 each, 2 for \$13.00.

MINIATURE BROADCASTING STATION FOR MICROPHONE AND PHONO WITH CRYSTAL MICROPHONE SALE PRICE \$9.95

Sensational new model MCL-E3 miniature broadcasting station for microphone and phonograph. Can be received on any broadcast radio in the home. No wires to connect, no jacks for crystal mike or record player. Complete with 12K8 and 70L7 tubes and instructions. Operates on 110 volts AC. Simple to operate; one control fades from microphone to record. Frequency can be adjusted so as not to interfere with local radio stations. Miniature broadcasting station, complete with crystal hand mike and instructions. Ship. wt. 4 lbs. Net price \$9.95.

IMPORTANT NEWS FOR SERVICE TECHNICIANS

new subscription plan keeps you right up-to-date on

HOWARD W. SAMS

"TELEVISION TUBE LOCATION CHARTS"

get this sturdy loose-leaf binder and stay right up-to-the-minute with Chart releases issued regularly every three months!



Now you won't have to wait a year or more to obtain your tube location charts on the current TV receivers! Subscribe to the new Sams Television Tube Location Guide service, and get current coverage at 3 month intervals. A sturdy, deluxe binder is supplied to you as part of the service, and the releases come to you already punched and ready for easy filing. Here's what your subscription includes:

Current Charts Every Three Months
Complete Cumulative Indexing Service
Deluxe Binder for Easy Filing

YOU GET A FULL YEAR'S SUBSCRIPTION INCLUDING **\$3.95** THE BINDER FOR ONLY....

Subscribe today at your Sams Distributor and start getting your current Sams Television Tube Location Charts NOW!

HOWARD W. SAMS & CO., INC.
2203 East 46th Street
Indianapolis 5, Indiana

SUBSCRIBE TODAY!

New TV Rectifier (Continued from page 57)

tification taking place within this element, rather than at a junction. It is therefore much easier to control production of germanium rectifiers.

No circuits for germanium-diode power supplies are shown because these configurations are entirely familiar: they are identical with supplies using selenium rectifiers. Load capacitors in the filter circuits used for the germanium devices are recommended to be in the range from 100 to 300 μ fd. Where selenium-to-germanium replacements are being made, clearly no changes are needed here. The 4-ohm minimum value for the surge-limiting resistor required for any of the germanium units now available is less than that required for comparable selenium rectifiers, so there will not usually be changes in this item—except where the technician may wish to take advantage of the slightly higher "B+" made possible.

Typical voltage-regulation curves, shown in Fig. 2 for a 1N573 germanium diode with various values for the capacitive load, tell an interesting story when compared to a curve for a comparable selenium unit. With the lower internal voltage drop, the germanium rectifier begins by yielding a greater output voltage to the external circuit and, as drain by the circuit is increased, voltage output from the germanium power supply holds up much better. To the service technician, the switch to a germanium rectifier means a convenient solution to many elusive problems where critical operation is associated with marginal "B+" supplies or drops in line voltage.

To the set owner, the high reliability of germanium rectifiers and the long

life that may be expected of them will be welcome. The new units are expected to outlast their receivers.

Since selenium rectifiers age with use, showing decreased output as time goes on, they have to be derated for use in equipment. This is to say that, when a unit is being selected for use in a particular piece of equipment, it is chosen to be over-sized in the electrical sense, so that it will still be useful in the circuit as its rated capacity to deliver voltage and current falls off. Since there is no aging problem with germanium rectifiers, a germanium unit that is used to replace a selenium unit may safely have a lower nominal rating.

An actual example of this difference in rating for comparable units is taking place in current *G-E* production of its line of 17-inch portable TV receivers. The original circuit called for a pair of selenium diodes rated at 300 ma. each. Newer models use a pair of germanium units rated at 250 ma. each. For the technician planning a substitution, the best bet is to measure current drain on the rectifiers to decide on the current rating of the replacement unit rather than to use the rating of the selenium device as a guide.

As for testing when a defective rectifier is suspected, the procedure is similar to, but simpler than, that used for a selenium unit. Forward and reverse resistance readings, taken directly across the diode with an ohmmeter, are compared, but no critical readings are given as standards. Aging or loss of efficiency do not occur with germanium rectifiers. A short is the only type of defect that can occur. Therefore, if resistance readings taken in both directions are low, the unit is shorted and should be discarded. In all other cases, the rectifier may be considered as still good. —30—

A 4 to 5 ton gas turbine section is correctly and accurately placed into position with the aid of a General Electric "Inratel" closed circuit television camera. Previously the turbine shells were aligned only by stretching a taut wire through the turbine and estimating when the shells were in position. In the present system the camera is bolted, leveled, and centered on the first or master shell. When another shell is to be attached, a target is centered in the new shell and the camera lens focused to the known distance to the target. Then by watching the monitor, located some 15 feet from the camera, it can be seen where the target lies in relation to the camera lens. Thus the shell-connecting bolts can be carefully adjusted and the new shell can be aligned. Monitor employs 600-line resolution.

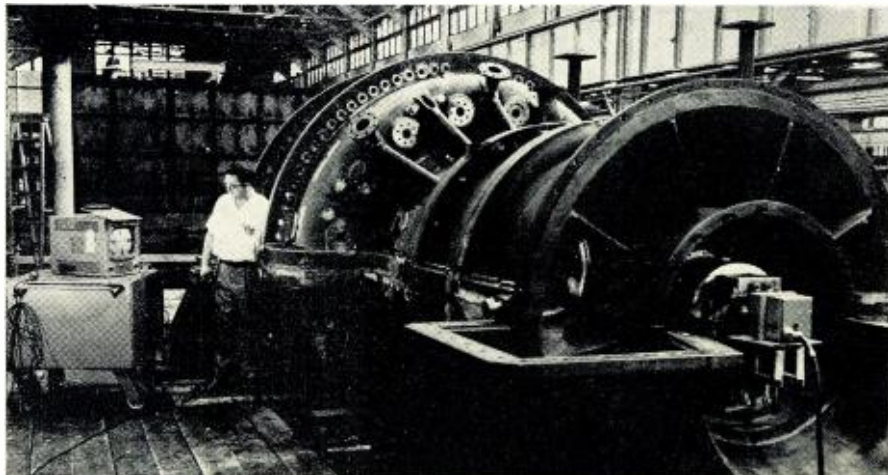

RADIO & TELEVISION NEWS

STANDARD LINE

MANUFACTURERS
ORDERS INVITED
EXPORT ORDERS
INVITED

FEATURING
FAMOUS FACTORY

TUBES

- INDIVIDUALLY BOXED!
- GUARANTEED ONE YEAR!
- FACTORY BOXED ● FACTORY IRREGULARS
- NEW JAN SURPLUS ● EQUIPMENT TUBES

**ALWAYS 1000
TYPES IN STOCK**

FREE POSTAGE! On All Orders
Shipped In U.S.A., Territories and
A.P.O.'s. Send 25c for handling on or
ders under \$5.00. Please send approx.
postage on Canadian and foreign
orders. Excess will be refunded.

Below Is A Partial List—Send For FREE Complete List and Order Form

QZ4	.42	SAT8	.79	6BK7	.75	7A4	.46	12J5	.39
1A7GT	.42	5J6	.79	6BL7GT	.74	7A5	.52	12L6	.59
1B3GT	.66	5T8	.79	6BN6	.57	7A6	.44	12SA7	.47
1C5GT	.40	5U4G	.48	6BQ6GT	.79	7A7	.44	12SG7	.54
1C6	.25	5U8	.79	6B07	.75	7A8	.44	12SJ7	.44
1C7G	.25	5V4G	.57	6BY5G	.57	7A7	.69	12SK7	.47
1D5GP	.42	5V6GT	.49	6BZ7	.75	7B4	.43	12SL7GT	.59
1H4G	.45	5Y3	.38	6C4	.36	7B5	.40	12SN7GT	.56
1J6GT	.46	5X8	.79	6CB6	.50	7B6	.41	12SQ7	.39
1L4	.45	5Z3	.44	6CD6G	1.17	7B7	.42	12V6GT	.44
1L6	.54	6A7	.56	6CU6	.79	7B8	.46	12W6	.59
1LA4	.55	6A8	.46	6D6	.47	7C4	.40	12X4	.36
1LA6	.46	6A7	.46	6E5	.43	7C5	.41	14A7	.44
1LB4	.58	6A8	.46	6F5	.36	7C6	.42	14B6	.44
1LC5	.48	6AB4	.44	6F6	.37	7C7	.44	14Q7	.44
1LC6	.46	6AC7	.66	6F6	.37	7E5	.44	19T8	.69
1LD5	.56	6AF4	.75	6H6	.37	7E5	.44	19BG6G	.44
1LE3	.56	6AG5	.49	6I4	1.59	7E6	.48	25B06GT	1.17
1LH4	.63	6AG7	.68	6I5	.38	7E7	.58	25B06GT	.84
1LN5	.46	6AH4G2	.69	6I6	.48	7F7	.65	25CA5	.79
1NSGT	.49	6AH6	.70	6K6GT	.38	7F8	.74	25CDE	1.29
1R5	.50	6AK5	.53	6K7	.47	7G7	.57	25CU6	.99
1S5	.45	6ALS	.41	6L6	.59	7N7	.58	25L6GT	.46
1T4	.50	6AM8	.79	6M7	.39	7Q7	.64	25W4GT	.42
1U4	.46	6AN8	.79	6Q7	.39	7X7	.64	25Z6	.36
1U5	.45	6AN8	.79	6S4	.39	7Y4	.34	27	.24
1V2	.70	6A55	.47	6S8GT	.70	7Z4	.39	35B5	.47
1X2	.66	6A57G	2.25	6S8GT	.47	12A4	.59	35C5	.47
2A3	.49	6AT6	.38	6S7Y	.75	12A6	.59	35L6GT	.46
2A7	.54	6AT7	.79	6S7	.47	12AB5	.49	35S5	.47
2D21	.95	6AU4GT	.64	6S7	.40	12AQ5	.40	35L6GT	.46
3A4	.50	6AUSGT	.60	6S7	.42	12AT6	.65	35Z3	.38
3A5	.50	6AU6	.42	6S17	.42	12AT7	.42	35Y4	.38
3A5	.50	6AUSGT	.64	6SK7	.49	12AU6	.58	35Z5GT	.38
3AL5	.52	6AV8	.79	6SL7GT	.56	12A7	.41	39/44	.25
3AU6	.52	6AV6GT	.38	6SN7GT	.56	12AV6	.66	50A5	.47
3BZ6	.57	6AV8	.89	6SQ7	.40	12AV7	.66	50B5	.47
3BC5	.57	6AX4GT	.65	6S7	.40	12AX4GT	.62	50C5	.47
3BN6	.57	6AX5GT	.56	6T4	.85	12AX7	.62	50L6GT	.44
3CB6	.57	6BA6	.46	6T8	.67	12A7	.67	80	.39
3Q4	.55	6BC5	.49	6U5	.54	12B4	.45	84/6Z4	.45
3Q5GT	.56	6BC8	.89	6V3	.79	12BA6	.59	117L7GT	1.25
3S4	.46	6BD5GT	.52	6V3	.79	12BA7	.59	117N7GT	1.25
3V4	.55	6BE6	.45	6V6GT	.45	12BE6	.45	117P7GT	1.25
4BQ7	.75	6BF5	.39	6W4GT	.39	12BH7	.59	117Z3	.36
4BZ7	.75	6BG6G	1.17	6W6GT	.52	12BY7	.63	117Z6GT	.61
5AM8	.79	6BH6	.50	6X4	.38	12CA5	.59		
5AN8	.79	6BJ6	.46	6X5	.38	12CUC6	.79		
5A95	.49	6BK5	.67	6X8	.74	12DQ6	.79		

Receiving Tubes Sent Parcel Post

Any 10" Tube\$10.75
Any 12" Tube\$12.75
Any 14" Tube\$14.75
Any 16" Tube\$16.75

All Picture Tubes sent Railway Express F.O.B. our
warehouse. Sorry, no A.P.O. shipments.

**FREE
12" TV SET**
with every receiving
tube order of \$100.00
or more!

**FREE
16" TV SET**
with every receiving
tube order of \$200.00
or more!

**FREE
25**
ASSORTED RESISTORS
with every tube
order of \$6.00 or
more!

Bonus TV sets
are shipped
complete with
cabinet and pic-
ture tube F.O.B.
our warehouse.
With slight adjust-
ments and mini-
mum labor they
can be restored
like new.

REMEMBER—
You Buy Quality
When You
Buy Stand-
ard. Qual-
ity Never
Shouts—It
Always
Whispers.

Thousands of TRADE-IN TVs

Reconditioned By Factory Trained Technicians! Guaranteed To
Be In Working Condition When You Receive Them!

10"	\$25.00	19"	\$56.00
12"	\$30.00	20"	\$63.00
14"	\$35.00	21"	\$70.00
16"	\$42.00	24" (when available)	\$95.00
17"	\$49.00	27" (when available)	\$129.00

Get yourself a second set or buy some for re-sale!
FREE BONUS . . . two set coupler given with each set.
All TVs sent motor freight or Railway Express F.O.B. our warehouse.
Sorry, no A.P.O. shipments.

Please Specify Console
or Table Model
When Ordering

We Are Not Selling
Price—We Sell
Only Quality

STANDARD LINE

ELECTRIC COMPANY

432 HARRISON AVENUE, HARRISON, N. J. • Phone: HUmboldt 4-4997

BUY THE WORLD'S MOST COMPLETE HI-FI GUIDE!



164
PAGES!

Compiled by the Editors of Popular Electronics

NINE BIG CHAPTERS ON!

- Why and How Hi-Fi
- Tuners
- Tapes
- Record Players and Changers
- Tone Arms, Cartridges and Needles
- Preamplifiers and Amplifiers
- Loudspeakers
- Speaker Enclosures
- Saving Money in Hi-Fi

Also included in this new Hi-Fi volume is a helpful YEARBOOK SECTION covering all the latest trends in high fidelity. This "book within a book" lists the nation's outstanding Hi-Fi records and artists, all FM stations, and contains a complete calendar of 1957 Hi-Fi Shows, plus a directory of Hi-Fi literature available free!



BE SURE TO BUY YOUR COPY!

NOW ON SALE AT ALL NEWSSTANDS AND RADIO PARTS DEALERS!
Price: 75¢

Jobs for the V.T.V.M.

(Continued from page 69)

are exactly as shown for the impedance-boasting resistor in Fig. 2A.

Impedance Checking

A convenient set-up for impedance checking is shown in Fig. 3. Here, the impedance (Z_x) to be measured is connected in series with a signal source (usually an audio oscillator) and a calibrated variable resistor, R . The a.c. v.t.v.m. is connected in parallel with the unknown impedance. A s.p.s.t. switch, S , is connected to short-circuit the resistor during one step in the test procedure.

The first step is to close switch S and adjust the output of the signal source for full-scale deflection of the v.t.v.m. Next, the switch is opened, and resistor R adjusted until the meter deflection falls to half-scale. At this point, the unknown impedance Z_x must equal the resistance R , since voltage is divided equally between them, and this value may be read from the calibrated dial of the resistor. The assumption is made that the unknown impedance is largely resistive and that the input resistance of the v.t.v.m. is many times higher than the unknown impedance.

When the input resistance of the meter is comparable to the resistance

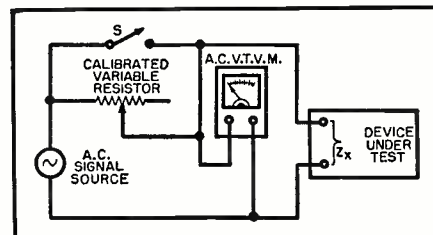
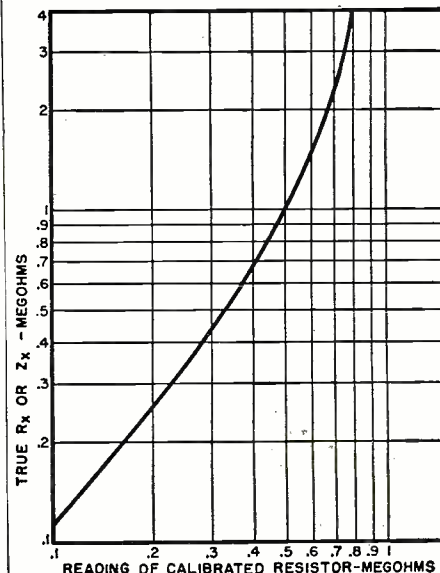

Fig. 3. Checking an unknown impedance.

Fig. 4. Unless unknown impedance (test of Fig. 3) is considerably smaller than meter input resistance, use this chart to determine Z_x or R_x more accurately.



Two Great Names
get together . . .

Plasti-Kote and Argos



To Serve
The Electronic
Technician

Developed by
electronic engineers
for electronic experts
—with the highest die-
lectric strength—800
volts/mil.

The best ever
offered for coating
terminals, rust proof-
ing antennas and
other electronic uses.

\$1.27 Dealer Net
16.4 oz.

Ask your Argos parts distributor now!

Argos

PRODUCTS COMPANY
310 MAIN STREET • GENOA, ILLINOIS

NOW a tube caddy*
for every purpose

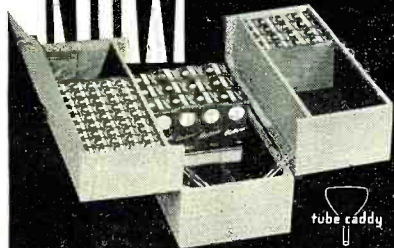

the **JUNIOR**
\$9.50 Dlr. Net. Ideal for quick
trips. 15 3/4 x 12 1/2 x 8 in. Model
TC-2A

the **CARRY-ALL** \$14.50 Dlr. Net.
Takes tubes, tools, meter. 21 x 15
x 8 in. Model TC-4

the **ORIGINAL** \$14.50 Dlr. Net.
Favorite of thousands. Upright de-
sign. 21 x 15 x 8 in. Model TC-1C

*Reg. TM of Argos Products Co.,
originators and leading manufacturers of
tube cases for the electronic technician.

Argos

PRODUCTS COMPANY
310 MAIN STREET • GENOA, ILLINOIS

Craftsmanship in Cabinets

or impedance of the device under test, or is lower, the results obtained by this method can be considerably in error. This often is of concern when using an a.c. v.t.v.m. having an input impedance of 1/2 or 1 megohm. (The author ran into this difficulty recently when attempting to measure the 1.2-megohm input impedance of a common-collector transistor amplifier stage.) When the meter resistance (R_m) is comparable to the unknown resistive impedance (R_x); R_x does not equal R when the latter is set for half-scale deflection of the meter, but $R_x = 1/(1/R - 1/R_m)$. This equation takes into account the shunting effect of the relatively low input resistance of the meter.

It would be rather tedious to run through this calculation at every new setting of the variable resistor, so Fig. 4 has been prepared to spare the reader this chore. The curve has been drawn with reference to 1-megohm input impedance. Referring to this chart, we see that a calibrated-resistor reading of 0.5 megohm, for example, actually indicates an unknown value of 1 megohm.

Current Shunt

At audio frequencies the measurement of a.c. current, especially in milliamperes, often poses a problem. The v.t.v.m. may be converted easily into an a.c. milliammeter or ammeter by connecting an external, non-inductive shunt resistor of the proper value across its input terminals, as shown in Fig. 5.

Since $E = IR$, by Ohm's Law, and since the resistance across the meter terminals is fixed at 1 ohm, the voltage across the resistor (read by the meter) will vary in step with the current through that resistor. Since R has been chosen to be 1 ohm, the voltmeter is made to read directly in terms of current without re-interpretation of its readings. Thus 1 volt read on the meter across a 1-ohm resistor will indicate 1 ampere of current flow. One millivolt will indicate one milliampere of current flow, etc. A 1-watt precision resistor may be used to measure all currents up to 1 ampere. Beyond 1 ampere, a higher wattage rating should be used.

The shunt resistor may be provided with a pair of banana jacks for plugging it into the input binding posts of the v.t.v.m., and a pair of binding posts for connection to the current source. Such a unit, built into a discarded plastic parts box as a plug-in accessory, is shown in Fig. 1 at the lower right.

Fig. 5. External shunt resistor (1-ohm non-inductive) converts the v.t.v.m. into an a.c. ammeter or milliammeter.

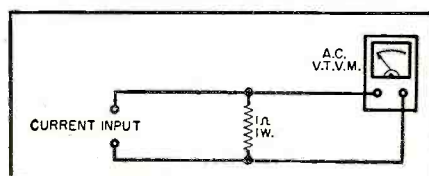

BUILD THE BEST— BUILD ALLIED'S OWN knight- kits

ALLIED stakes its 36-year reputation in the Electronics field on your complete success and fullest satisfaction with KNIGHT-KITS. Join the thousands who have discovered the ultimate in kit value in...

knight-kits

LOWEST COST because our giant buying power passes biggest savings on to you... you do the easy assembly and your finished instrument is equal in performance and appearance to equipment selling for several times the KNIGHT-KIT cost. (Easy Payment Terms available, too.)

knight-kits

EASIEST TO BUILD because KNIGHT-KIT "Step-and-Chek" instruction manuals are marvels of clarity—it's just like having a good instructor at your side. Proved professional design and premium quality parts help insure your building success.

knight-kits

MONEY-BACK GUARANTEE:
When properly assembled, KNIGHT-KITS fully meet published specifications, or we refund your money.

**WHEN YOU BUILD A KNIGHT-KIT
YOU BUILD THE BEST**

For a Complete Selection of
Famous knight-kits
SEE PAGES 127-133

Available Only From
ALLIED RADIO
100 N. Western Ave., Chicago 80, Ill.



Still a big
HIT!
the ALL NEW
BASEBall
auto antenna

Yes, it's a HIT! A NEW and IMPROVED automobile antenna with more on the ball than anything you've ever handled. Positive grounding action!... no wet-weather shorts!... finest triple-chrome plating!... designed by the same team that produces original equipment antennas for Bendix, Emerson, DuMont, G. E., Lear, Motorola, RCA, Westinghouse and Zenith.



CONTRACT MANUFACTURERS FOR 1001 APPLICATIONS
the antenna specialists co.
12435 EUCLID AVE. • CLEVELAND, OHIO
Dept. RT-3
America's only complete line of vehicular communication antennas.
Write For Complete Data and Prices.

Transistorized Superhet

New six-transistor kit is well engineered, easy to construct, and offers performance comparable to many commercially built pocket receivers.

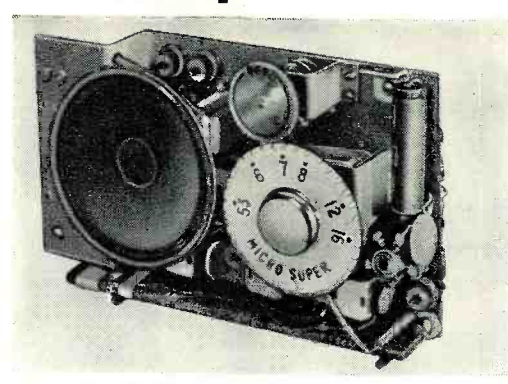

Over-all view of the KT-119 superhet kit.

HERE is a unit that is completely transistorized and makes maximum use of all the latest miniaturization techniques—including specially built speaker, transformers, coils, variable capacitor, and volume control—all of which are of unique and specialized design.

This six-transistor circuit may be constructed on a chassis which measures 6" (over-all) long, 3½" wide, and has a 1" flange. The speaker is a 2¾" diameter unit and the over-all performance of the receiver compares favorably with many of the commercially built transistor "personal portables" on the market today.

For those who are seeking a compact portable but do not relish the job of constructing their own, the commercial models offer the best out. But for those who enjoy "building their own" or want added experience working with transistor circuitry, this Lafayette KT-119 kit would be hard to beat. This is one of the best engineered transistor equipment kits to come to our attention.

The circuit makes use of three high-frequency r.f. transistors, three audio transistors, and a crystal diode detector. The r.f. section employs specially matched components including a variable tuning capacitor, a "Hi-Q" loop, oscillator coil, and a matched set of three i.f. transformers. The audio section features matched audio interstage and output transformers to provide efficient power transfer to and from the class B push-pull output stage. The built-in speaker may be used for group listening or the accessory earphone can be plugged

into the phono jack for personalized listening.

The kit can be assembled without difficulty using readily available tools. The only suggestion that the manufacturer has to offer is that a 30 to 40 watt soldering iron be used because of the compactness of the circuit and the possibility of damaging the transistors should too much heat be applied.

One point regarding this kit should be mentioned for the benefit of would-be constructors. The kit of parts, as received at this office, contained a bad oscillator coil. This may have been one of those "one in a thousand" chances but there is no way of checking this point. Locating this bad oscillator coil wasn't an easy task. Lack of oscillation cannot be determined as simply as could have been done with tube type oscillators. Actually what we did was use another AM receiver and when holding the transistorized unit with the oscillator close to the antenna of the receiver it was possible to determine whether or not there was oscillation.

Another point, like any receiver of this type, its range is limited to about twenty-five miles. This should be more than adequate in most urban areas.

In view of the many specialized sub-miniaturized components used in this circuit to insure the requisite compactness, it is advisable to buy the packaged kit rather than to try to purchase the individual components. The basic chassis kit is priced at \$33.50 with the leather carrying case available for \$2.95 extra.

Schematic diagram of six-transistor superhet. Special parts are used extensively.

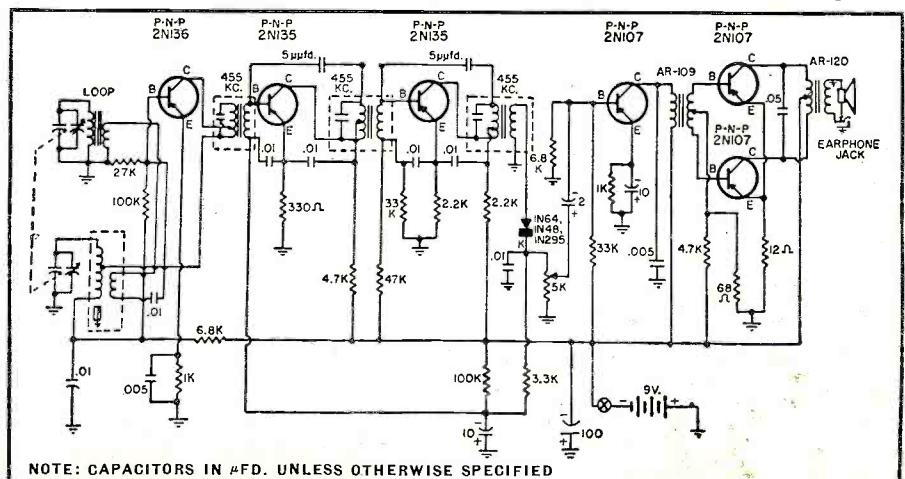

NOTE: CAPACITORS IN µFD. UNLESS OTHERWISE SPECIFIED

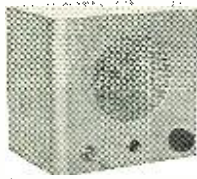

POWER SUPPLY
110 V. For Army/Navy
COMM. RECEIVERS
Eliminates set conversion.
For use w/BC-453-454-455-
946 or any sets requiring 24
V. @ 1 A. & 250 V. @ 50
MA. Ready to use; has 4"
speaker, volume control, CW
and on-off switches. Com-
plete with cord and plug
/free.
Price....NEW: **\$18.95**

**NOW—OPERATE BEACON
RECEIVER FROM 12 VOLT**

BC-1206CM BEACON RE-
CEIVER: 200-400 KC. 5
Tubes, 135 KC IF, operates
from 24 VDC—**\$9.95**
New.....\$5.95
Used.....\$4.95
For 12 Volt operation, use
this PM DYNAMOTOR—12
VDC input, output 24 VDC.
Size: 2 1/2" x 4" x 4"
7" Dyn.Only **\$4.95**

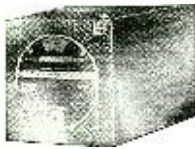

AC. POWER SUPPLY—To operate BC-1206 from 110
Volt 60 cycle. Complete with Speaker, etc., in same
type cabinet as illustrated at top of this
column—Price **\$18.95**

PE-110 AC POWER SUPPLY

115 Volt 60 cycle Power Supply for BC-669 Rec.-Trans.
Complete with Tubes, 25 ft. AC Power Cord, Spare
Tubes, Vibrator, Capacitor, Fuses. Housed
in wood chest. Brand New..... **\$59.50**

**FM RECEIVERS AND
TRANSMITTERS**

27 to 38.9 MC. FM RECEIVER

Four Pre-selected Channels & Squelch Circuit. Com-
plete with 16 Tubes and Speaker. Set size: 6 1/2" W x
1 1/2" H x 1 1/2" D. Power required 12 or 24 VDC
& 275 VDC 150 MA. BC-923 RECEIVER—Used,
Checked.....\$34.95
12 V. DYNAMOTOR For BC-923:.....\$5.95; Used: \$3.95
A.C. POWER SUPPLY For BC-923.....\$22.50
KIT of Parts & Wiring Diagram for BC-923.....\$17.50

27 to 38.9 MC. FM TRANSMITTER

30-Watt companion to BC-923 Receiver. Four Pre-se-
lected Channels, Voltage regulated M O control, using
2/815, 2/6S17, 1 each 6SL7, 6V6, 615, 6AG7, &
VR-150 Tubes. Size: 11" x 11" x 18". Voltage re-
quired: 12 or 24 VDC & 400 VDC @ 400 MA.
BC-924 TRANSMITTER.....New: \$24.95; Used: \$14.95
Power & Control Plug f/BC-923 or BC-924.....\$1.00
Mounting Base FT-237 f/BC-923 & BC-924.Used: \$9.95

BC-603 RECEIVER: 20-28 MC variable tuning, 10 Pre-
Set push button channels, squelch circuit, 4" speaker;
10 Tubes: 2/12SG7, 2/6SL7, 1/6V6, 1/615, 3/6AG7, &
1/6H6. Prices:.....NEW: \$39.95; USED: \$29.95
PLUG for rear of Receiver.....\$1.00
DYNAMOTOR: 12 V input; Output 220 V 80 MA—
#DM-34.....NEW: \$4.95; ReISSUE: \$2.95
BC-604 TRANSMITTER: 20-28 MC, 30 Watt, com-
panion to BC-603 Receiver. Crystal control, 10 Pre-
Set channels, interphone communication, 8 Tubes
7/1619 & 1/1624.....USED: \$18.95
PLUG for rear of Transmitter.....\$1.00
DYNAMOTOR: 12 V input; Output 625 VDC 225 MA—
#DM-35.....USED: \$9.95
FT-237 BASE for mounting Receiver &
Transmitter (No Plugs required).....USED: **\$9.95**

NATIONAL DIAL

TYPE "N" Precision 4" di-
vided scale with
decimal vernier drive 5:1 ratio. Planetary
drive fits 1/2" shaft, 100-0 scale.
Prices: 3 for \$5.00.
Each: **\$1.95**



**PANORAMIC ADAPTER
AND OSCILLOSCOPE — ID-60/APA-10**

Two Units in One. Panadapter and Scope with three
inputs for feeding IF. Freq. of 455 KC, 5.2 or 30 MC
from Receivers, viewing on 3" Scope. Also can be
used as regular scope. Has vertical and horizontal
push-pull amplifier inputs. Complete with 21 tubes,
instruction book, and schematic. Operates from 115
Volt 400 cycle. (Not demilitarized)
NEW: **\$49.50**

COMMAND EQUIPMENT

	USED:	NEW:
550 to 1500 REC., Navy.....	\$14.95	\$19.95
550 to 1500 REC., Navy w/ant. loop. Sw.		24.95
1.5 to 3 MC. REC., Navy.....	9.95	
3 to 6 MC. REC.—BC-454.....	9.95	
6 to 9 MC. REC.—BC-455.....	7.95	
100 to 156 MC. REC.—F-28.....	10.95	18.95
2.1 to 3 MC. TRANS., Navy.....	7.95	9.95
3 to 4 MC. TRANS., Navy.....	5.95	
4 to 5.3 MC. TRANS.—BC-457.....	4.95	
5.3 to 7 MC. TRANS.—BC-458.....	4.95	
7 to 9 MC. TRANS.—Navy.....		7.95
100 to 156 MC. TRANS.—T-23.....	14.95	

TELEPHONE & CONTROL EQUIPMENT

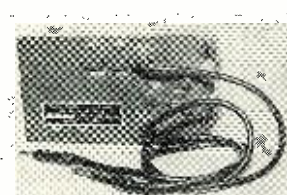

• **CONTROL UNIT RM-53—**
(Pictured at left.) Used to
operate radio equipment and
provide remote control and in-
tercom, of such equipment by
use of the RM-52 Unit listed
below. Up to 1/2 mile, uses 2
flashlight batt. Internal trans-
former has High-Low impe-
dance Sw. and Sidetone. Also
Mic. & Phone Jack & PL-55
& PL-68 Plugs.
USED: **\$3.95** NEW: **\$5.95**

REMOTE CONTROL RM-52—
(Pictured at right) Can be used
with RM-53 or used as a separate
telephone system. Up to 1/2 mile.
Uses 4 flashlight batt. Also can
be used as a direct remote control
for radio equipment. Provides bias
for Mic. & Sidetone to headset.
High or Low Imp. Also Mic. &
Phone Jacks.



USED: **\$2.95** NEW: **\$4.95**

TS-13 HANDSET for RM-53 or RM-52.....Used: \$5.95

EE-8 FIELD TELEPHONE

Ideal for private telephone system for two or more phones,
up to 17 miles. Hand ringer, generator with handset,
carrying case. Uses 2 flashlight batt. Used—
Checked.....\$14.95
WIRE—Weatherproof Twisted Pair: 500 ft. \$4.75—135
ft. \$1.00—2500 ft. \$19.95. Per Foot at 1 1/2¢.
COMBAT WIRE—Rubber covered W-130...\$.01 per Ft.

TA-12B BENDIX TRANSMITTER

Frequency 300-600 KC and 3000 to 7000 CW & MCW
100 Watt. Four separate oscillators easily converted to
cover 20-40-80 Meters by using crystal for 10 Meter
Band. Selector channel switch changes ECO, IPA, and
Output Tanks at one time. All controls mounted on
front panel. Uses 3/807, 1/6F5, 1/2SN7; also has output
Meter. Size: 1 1/2" x 1 1/4" x 6 3/4". Com-
plete with Tubes, Plug and Cable. Used: **\$32.95**

For Conversion—See Surplus Manual #2—Price: \$2.50
MP-28-BA MODULATOR & POWER SUPPLY FOR
TA-12: Modulated Max. Signal Carrier output 75 Watts
Class B. Uses 2/807, 1/6F5, 1/2SN7. Dynamotor input
24 VDC output 540 VDC 450 MA.
Prices.....New: \$14.95—Used: \$10.95

RA-10 BENDIX RECEIVER

150-1100 KC and 2-10 MC. Excellent for range and
marine use. Tubes: 3/6SK7, 1/6K7, 1/6C5, 1/6K6G,
1/6K8. Complete with Dynamotor, MR-9 Control Box,
Plugs, Remote Tuning shaft. Size: 10" x 8 1/2" x 17".
RA-10 DA—24 Volt 150-1100 KC & 2-10 MC. U:
Used.....\$34.95
RA-10 CA—12 Volt 150-1100 KC & 2-10 MC. U: \$39.95
RA-10 FA—24 Volt 150-400 KC & 2-10 MC. U: 29.95
Surplus Conversion Manual—#1 or #2.....Ea.: 2.50
For List of contents in each Manual, send 3¢ stamp.

METERS:

WESTON AC AMMETER:
(Pictured) in portable leather case,
with Test Leads, 2 1/2", 0-15
AC and 0-3 AC Scale..... **\$5.95**



DC AMMETER HOYT: In portable
metal case, with Test Leads, 4 1/2", Fan
Mirrored Scale 0-15 ADC.....\$4.95
D METER 10 to Plus 6 Westinghouse 3",
MC-35 Imp. 600 ohm @ 1000 cycle..... 4.95
0-1 MA Weston 506; 2 1/2" Rd..... 3.95
0-3 RF AMMETER IS-128; 2 1/2" Rd.....NEW: 2.95
0-8 Amp RF w/Thermocouple IS-89; 2 1/2" Rd..... 4.95
0-15 AC-DC—2 1/2" Rd.; IS-122..... 4.95
0-500 MA DC—2 1/2" Rd.; IS-22..... 4.95
0-150 60 cycle; Simpson; 3 1/2" Rd..... 3.95
0-250 MA DC—DeJure; 3" Sq..... 3.95
OUTPUT—5 Ranges, 4000 ohm Imp.—Used..... 4.95

PRACTICE CODE TAPE:

SETS: INKED PAPER TAPES—For Code
practice and training—for Radio Operators,
Hams, Amateurs, Beginners, and Telegraphers.
15 lessons to a Set, on 16mm 400 ft. reels that
can be reproduced on TG-34A and TG-10 Keyers.
Price: SET of 15 Reels in wood **\$18.95**
case
REELS: Lesson Reels available individually. Order
by number desired, 1 thru 15.....Each: \$2.00

**100—156 MC TRANSMITTER
& RECEIVER—SCR-522 TRANS. &**

RECEIVER: 100—156 MC, 4 Channel, Crystal Control,
AM Voice Operation, 18 Tubes—Trans.: 2/832, 3/12A6,
1/6SS7, 1/6G6—Rec.: 1/9002, 1/9003, 3/12A6, 2/12AH7,
1/12C6, 1/12H6, & 3/12SG7. Complete with Tubes,
Schematic, and Conversion Info. for ama-
teur use—Good Cond. **\$34.95**
REC.—Chassis Only, w/Tubes \$19.95 without.....\$9.95
TRANS.—Chas. Only, w/Tubes \$22.50 without.....\$9.95
SCHEMATIC and Conversion Info. Only.....\$2.50

**RADAR
TRANS.**



Transmitter Fre-
quency 143 to 194
MC. using one 3A5
Tube. In plastic
case 4 1/2" x 1 1/2"
mounted top of 58"
Telescoping Antenna
with 14" Dipole.
Battery Case for
holding 2/BA-30
1 1/2 V. & BA-38
10 1/2 Volt "B."
Has on & off Sw.
Tel. Ant. mounts
side of batt. case.
Price: **\$2.95**

BC-1158 TRANS. & MODULATOR:

Frequency coverage 53.3 to 95 MC. 50 Watt. RF
Doublers, Amplifier and Modulator Sections, using
4/815 and 10/12SN7 Tubes. Can be converted to
2-6-10- or 20 Meters. Complete with Tubes, Meter,
Blower,
etc.NEW: **\$39.95** Used: **\$29.95**

MICROPHONES & HEADSETS

F-1 BUTTON CARBON MIC.
(Pictured at left) High Gain—
Can be used on desk, car, hand,
or strapped to chest. Complete
with on-off Mom. **\$1.95**
Switch.....NEW: **\$1.95**
RS-38 CARBON MIC. with PL-68
Plug.....U: \$2.50
T-17 Carbon Mic.—Used, checked
\$3.95; N: \$8.95
Sound Powered Mic., no cord,
used, Checked:.....\$1.00
HS-30 HEADSET—Hearing aid
type.....U: \$1.50
HS-18 HEADSET—4000 ohm.....U: \$1.05
Sound Powered—One headpiece only.....U: \$1.00
Sound Powered Handset TS-10—Used, checked \$3.95
TS-9 Handset—Push to talk Sw. No plugs.
U: \$3.95; N: \$5.95
TS-13 Handset—Push to talk Sw. w/PL-68 & PL-55
U: \$5.95

DYNAMOTORS & GENERATORS:

INPUT VOLTS:	OUTPUT VOLTS:	STOCK NO.	PRICES USED:	PRICES NEW:
12 VDC	220	DM-34	\$2.95	\$ 4.95
12	225	D-402	5.95	8.95
12	625	DM-35	9.95	
12	230	PE-133	4.95	6.95
12	540	DA-12		14.95
12	230	100 DA-14		8.95
14	220	70 DM-24	4.95	7.95
14	1030	260 DM-42	4.95	9.95
14	515	215 WE-377	5.95	
14	425	163 BD-87	3.95	5.95
14 VDC	330	150 DM-25	6.95	8.95
14	250	50 DM-12		6.95
14	1000	350 BD-77	14.95	
14	230	90 DM-21	6.95	
24	250	60 DM-32	2.95	5.95
12	250	60 12V/DM-32		4.95
24	250	60 PE-86		8.95
28	1000	350 PE-73	8.95	

12 to 24 VDC PM Dynamotor—Supplies 24 VDC 2 A.
from 12 VDC, also 500 V 50 MA. @ 6 VDC will sup-
ply 12 VDC & 250 V 50 MA.NEW: **\$4.95**
#0515.....

**FAMOUS ARMY
SCR-625 MINE DETECTOR**

For Prospectors, Miners, Oil Companies, Plumbers,
etc. Portable unit for locating all types of
buried metal objects up to 24" or more depending
on size and ground condition. Detection by
means of a tone. Packed in a chest. Operating
weight approx. 15 lbs. Shipping wt. approx. 40
lbs. Complete with **\$39.95**
batteries

TRANSFORMERS and CHOKES

115 V. 60 CYCLE PRI. TRANS.:
600 VCT/100 MA—6.3 V/5 A; 5 V/3 A.....\$4.95
240 VCT/35 MA—24 V/9A; 6.3 V/6 A; 6.3
V/3 A..... 1.75
1500 VCT/260 MA—6.5 V/3 A.—6.5 V/5 A.—
5 V/4.5 A..... 9.95
700 VCT/150 MA—5 V/3 A.; 6.3 V/4.5 A. CSD..... 3.95
2500 V/015 A.; 2.5 V/175 A.; 6.3 V/6 A..... 5.95
1890 V/12.6 MA—Tapped 2.5 V 2 A..... 5.95
1100 V/80 MA—7.5 VCT/3.25 A..... 5.95
720 VCT/50 MA—6.3V/2.5 A.—5V/2 A..... 2.50
862 VCT/110 MA—6.3V/12 A.—5V/2 A..... 3.95
300 VCT/300 MA—12.6V/10 A.—5V/3 A..... 6.95
16 Volt 35 Amp. 115/230.....\$14.95; 24V—1 Amp 1.50
9 Volt CT—35 Amp.—Tapped 4.5 V..... 7.95
12 Volt—Two separate windings—4 amp each..... 5.95
5 V/2 A.; 5 V/2 A.; 5 V/2 A.; & 5 V/6 A..... 2.95
6.3 V/2 A.; and 5 V/3 A..... 1.75
600-0-600 VAC—200 MA. 12.5 V. 2 A.; 12.5 V.
@ 2 A.; 5 V. @ 3 A. # H-108—Price..... 8.95
250-0-250 VAC—50 MA. 24 V. 1A.; and 6.3 V.
1 A.—# H-109—Price..... 4.95

Choke—12.5 Hy/100 MA.....\$1.95
Choke—8 Hy/150 MA—200 Ohm—Open Frame..... 1.25
Choke—5 Hy/150 MA—85 Ohm..... 1.50
Choke—10 Hy/250 MA—2 1/2" x 4" x 3" Potted..... 4.95
Choke—5 Hy/400 MA—4 1/2" x 4" x 5 1/2"..... 4.95
"A" Choke—1 Hy @ 1 A. 7 ohm. Size: 2 1/2" x
2 1/4" x 2 1/4".....Price: 1.95

Address Dept. RN • \$5.00 Order Minimum & 25%
Deposit on C.O.D.'s • Prices are F.O.B. Lima, Ohio

FAIR RADIO SALES 132 SOUTH MAIN ST. LIMA, OHIO

LAFAYETTE SENSATIONAL VALUES! IN COMPLETELY WIRED TEST EQUIPMENT at LESS than the PRICE of KITS!

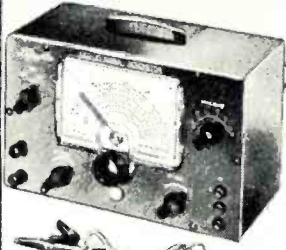

LAFAYETTE SIGNAL GENERATOR

NEVER BEFORE HAS A COMPLETELY WIRED AND TESTED INSTRUMENT OF SUCH ACCURACY AND QUALITY BEEN OFFERED AT SUCH A PRICE!

- FREQUENCY 120 KC TO 260 MC
- 120 KC TO 130 MC ON FUNDAMENTALS
- LABORATORY ACCURACY AND QUALITY

A completely wired and tested instrument not to be confused with units sold in kit form at almost the same price, but with a quality and accuracy of instruments 3 to 4 times its price. Six overlapping ranges generate signals of 120KC - 320KC, 320KC-1000KC, 1MC-3.2MC-11MC, 11MC-38MC and 37MC-130MC all on fundamentals with calibrated harmonics from 120MC to 260MC. Selector switch gives instant choice of ranges. Switch gives choice of internal modulation of 400 CPS or use of any external source at other frequencies. For audio testing the 400 cycle signal can be used separately. Outputs are unmodulated RF, modulated RF and 400 CPS audio. RF output is in excess of 100,000 microvolts and jacks are provided for choice of either high or low RF output. Stability is insured by special circuit design. Has a fine adjustment RF control. AF output is 2-3 volts, AF input is 4 volts across 1 megohm. Large clear 5 inch etched dial plate and pointer are protected by transparent plastic bezel. Common AF terminals for EXT-MOD input and INT-AF for audio tests eliminate need for special AF output connectors. Machine engraved panel lettering. Handsome gray metal case with carrying handle. Measures 6 1/2" x 10" x 4 1/2". Comes complete with pair of leads. AC line cord and plug. Operates on 105-125V 50-60 cycle AC. Shpg. wt., 8 lbs.

22.50

LAFAYETTE LSG-10 SIGNAL GENERATOR..... **22.50**

NEW POCKET AC-DC VOM MULTITESTER

2,000 ohm per volt Sensitivity on both DC and AC

160 μ a 3" METER
1% PRECISION
RESISTORS
SILVER CONTACT
SELECTOR SWITCH

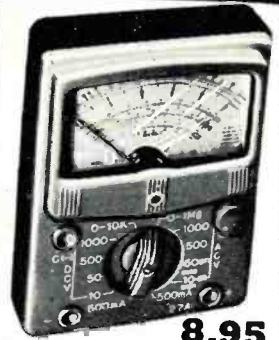

FULL SCALE RANGES

DC Volts: 0-10; 0-50; 0-500; 0-100 Volts - AC
Volts: 0-10; 0-50; 0-500;
0-1000 Volts—DC Current:
500 μ a and 500 ma —
Resistance: 0-10K; 0-1 Meg
— Decibels: -20 to +22;
+20 to 36 db (0 db —
0.775 V)—Capacity: 250
mfd to .2 mfd—.005 mfd
to 1 mfd—Output Ranges:
0-10; 0-50; 0-500; 0-1000
volts.

8.95

Best Buy in America! A very accurate and sensitive VOM. This Multitester is a complete instrument (not a kit) with high quality and sensitive 160 microamp meter; 2000 ohm per volt on both AC and DC. Single selector switch, 1% precision resistors, 3" meter. Features extreme versatility; accuracy and ruggedness. In attractive plastic front panel, with metal bottom for ruggedness and shielding. First capacity range requires 50 volt AC source. Second capacity complete requires 10 volt AC source. Size 4 1/2" x 3 1/2" x 1 3/8". Complete with test leads and batteries. Shipping weight 4 lbs.

RW-27A

Complete 8.95

NEW!

LAFAYETTE CAPACITANCE-RESISTANCE TESTER WITH "IN-SET QUICK CHECK"

COMPLETELY WIRED AND TESTED



- TWO INSTRUMENTS IN ONE
- CHECKS ELECTROLYTIC, PAPER, MICA AND CERAMIC CONDENSERS
- 4 DIRECT READING CAPACITY SCALES FROM .00001 MFD TO 1000 MFD
- CHECK FOR OPEN SHORTS, LEAKAGE AND INTERMITTENTS
- 2 RESISTANCE RANGES FROM 100 TO 5 MEGOHM

Here is a "must" for servicemen and lab technicians. A completely self-contained AC operated capacitance and resistance bridge, plus a quick check for in the set testing. Large 5" direct reading scale has 4 ranges of .00001-.005 MFD, .001-.5 MFD, .1-50 MFD and 20-1000 MFD. Resistance ranges are 100-50,000 OHMS and 10,000 to 5 megohm. Quick check feature enables you to check capacitors for shorts, open or intermittent while in circuit—no need to remove them from the set till you're sure they need replacement. Leakage test switch gives for checking leakage under correct potential. Separate power factor control with continuous settings from 0 to 50%. Operation is simple and accurate, using a magic-eye tube as the null detector. Attractively finished steel case with etched panel and rounded corners, measures 14 1/2" L x 8 1/4" H x 5" D. Shpg wt. 19 lbs.

34.50

you choice of 25, 150, 250, 350 or 450 volts for checking leakage under correct potential. Separate power factor control with continuous settings from 0 to 50%. Operation is simple and accurate, using a magic-eye tube as the null detector. Attractively finished steel case with etched panel and rounded corners, measures 14 1/2" L x 8 1/4" H x 5" D. Shpg wt. 19 lbs.

MODEL LC-4

NET 34.50

NEW!

LAFAYETTE CAPACITOR-RESISTANCE TESTER

COMPLETELY WIRED AND TESTED

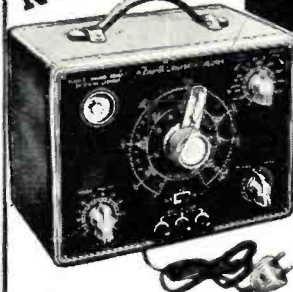

21.50

- COMPLETELY WIRED AND TESTED
- CHECKS ALL TYPES OF CONDENSERS FOR CAPACITY, LEAKAGE, OPEN SHORTS OR INTERMITTENT CONDITION
- DIRECT READING SCALES FROM .00001 TO 1000 MFD AND 100 TO 5 MEGOHMS

A stable and accurate bridge type circuit measures capacitance in 4 ranges of .00001-.005 MFD, .001 to .5 MFD, .1 to 50 MFD and 20 to 1000 MFD. Two resistance ranges of 100-50,000 and 10,000 to 5 megohms. Check leakage under actual load with choice of 25, 150, 250, 350 or 450 volts available by selector switch. Power factor control from 0 to 50%. Checks for leakage, open, short, or intermittent operation. All readings taken directly off scales after setting magic eye to maximum. Completely self-contained power supply. Attractively finished steel case with rounded corners and etched panel. Operates from 110V AC. Size 9 3/8" L x 7 1/8" H x 5 1/4" D. Shpg. wt. 10 lbs.

MODEL LC-15

NET 21.50

HIGH SENSITIVITY 20,000 OHM PER VOLT DC 10,000 OHM PER VOLT AC MULTITESTER

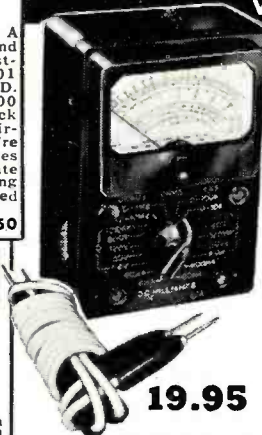

LOOK AT THESE FULL SCALE RANGES!

D.C. Volts: 0-6; 0-30; 0-120; 0-600; 0-1200; 0-6000 Volts — A.C. Volts: 0-6; 0-30; 0-120; 0-600; 0-1200 Volts — RESISTANCE: 0-10K; 0-100K; 0-1 Meg; 0-10 Megohms—D.C. CURRENT: 0-60 Microamp; 0-6; 0-60; 0-600 Milliamps — DECIBEL: -20 to +17 db (0 db—0.774V) — CAPACITY: .0001-.01; .005-.15 mfd — INDUCTANCE: 20-2000 millihenry — OUTPUT RANGES: 0-6; 0-30; 0-120; 0-600; 0-1200 Volts

19.95

The new Lafayette high sensitivity Multitester is a complete instrument (not a kit). In addition to its unusual sensitivity of 20,000 OHMS PER VOLT ON D.C. AND 10,000 OHMS PER VOLT ON A.C., and the extraordinary number and scope of its ranges, it is packed with features that would make it cost at least twice as much if made in this country. Uses 1% precision resistors, silver contacts on selector switch, 35 μ a 3" meter. Dependable, rugged and accurate. Even the test leads are heavy duty with high voltage insulation. Voltage source required for low capacity range is 120V A.C., for high range capacity and inductance scale is 6V A.C. Attractive plastic front with metal bottom. Size 6 1/4" x 4 1/4" x 2 1/2". Complete with batteries and leads. Shipping weight 4 1/2 lbs.

RW-30A

Singly, Each 19.95
In lots of 3, Each 19.25

BUILD A 6 TRANSISTOR SUPERHET RECEIVER

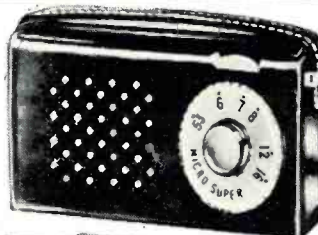

FOR GROUP AND PRIVATE LISTENING

- 100% SUBMINIATURE PARTS—NO COMPROMISES!
- LABORATORY DESIGNED—SENSITIVE, SELECTIVE, STABLE!
- CLASS B PUSH-PULL AMPLIFICATION—PLENTY OF POWER!

Superb Performance! Incomparable Value!

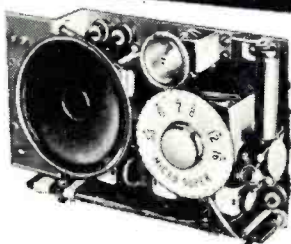

33.50

Transistor-wise Lafayette is proud to present its 6 Transistor Superhet Receiver Kit KT-119. An outstanding achievement of constant research and design, this kit represents the optimum in sensitivity, selectivity and stability. You'll be amazed at its superior commercial quality! You'll be elated with its surprising performance! The circuit, using 3 high frequency RF Transistors, 3 dependable audio Transistors and Crystal Diode, features a specially matched set of 3 I.F.'s, Oscillator, High-Q Loop, Class B Push-Pull Audio Amplification, and Transformer Coupling in audio and output stages. Special care has been taken in the design for exact impedance matching throughout to effect maximum transfer of power. Has efficient 2 1/4" speaker for exemplary reproduction, and earphone jack for private listening. Complete with all parts, transistors, pre-punched chassis, battery and easy-to-follow step-by-step instructions. 6" x 3 1/2" x 1 1/2". Shpg. wt., 3 lbs.

KT-119—Complete Kit—Less Case.....Net **33.50**

MS-339—Sturdy, attractive brown leather case with carrying strap for KT-119. 6" x 3 1/2" x 1 1/2". Shpg. wt., 1 lb.....Net **2.95**

MS-279—Sensitive matching earphone.....Net **2.39**

LAFAYETTE RADIO

DEPT. RC1

100 SIXTH AVE., NEW YORK, N. Y.
BOSTON, MASS., 110 Federal St.
PLAINFIELD, N. J., 139 West 2nd St.
NEWARK, N. J., 24 Central Ave.
BRONX, N. Y., 542 E. Fordham Rd.

JAMAICA 33; N. Y. 165-08 Liberty Ave. Write for FREE Bargain Packed Catalog!

FREE! LAFAYETTE CATALOG



ELECTRONIC CATALOG PACKED WITH MONEY SAVERS

Packed with the largest selection of Electronic, Radio and T.V. Parts, and equipment, P.A. Hi-Fi systems, tubes, antennas, Transistor Kits, parts and components, Test Equipment, new build your own kits, tools, books, Microscope, drafting equipment, Binoculars, Telescopes, All Radio, TV and Ham supplies — ALL AT GREAT SAVINGS — For the economy minded servicemen, dealer, engineer and technician. **CHUCK FULL OF BUYS! SEND FOR YOUR FREE COPY TO-DAY.**

PROFESSIONAL TRANSCRIPTION TURNTABLE AND VISCOUS-DAMPED TONE ARM THE FINEST TRANSCRIPTION TURNTABLE AND TONE ARM FOR THE PROFESSIONAL USER AND THE AUDIOPHILE



PK-100 TURNTABLE
PK-90 TONE ARM
AND G.E. CART-
RIDGE WITH GEN-
UINE DIAMOND
AND SAPPHIRE
STYLI.

72.50

**COMBINATION
DEAL**

PK-100A TRANSCRIPTION TURNTABLE

New 3-speed instrument with built-in stroboscope and viewer for exact speed determination, and magnetic brake for instantaneous speed variation. Precision engineered to meet professional standards for wow, rumble and flutter content. Heavy 12" cast aluminum rim-driven turntable. Variable speed control permits adjustment of each speed within $\pm 7\%$ using efficient frictionless magnetic brake. Heavy-duty constant speed 4-pole induction motor freely suspended and isolated by shock-mountings to eliminate vibration transference. R-C filter network suppresses "pop" in speaker. Truly a delight for the connoisseur. Size: 13 1/2" x 14" and requires 2 3/4" clearance above and 3 3/4" below motorboard. For 110-130V and 60/50 cycle AC. Power consumption 12 watts. Handsome hammertone gray finish. Shpg. wt., 20 lbs.

PK-100-A Net **49.50**

PK-90 VISCOUS-DAMPED TONE ARM

This transcription arm assures dependable and stable operation, utilizing the "floating action" principle of "viscous-damping." The arm is supported at a single point by a pivot and jewel bearing having negligible friction. Damping is accomplished by a silicone fluid occupying the gap between a ball and socket. This damping control permits high compliance and negligible tracking error, and prevents damage to either record or stylus should the tone arm be accidentally dropped. Low frequency resonance, skidding and groove-jumping are likewise minimized. The tone arm accepts all records up to 16" and accommodates virtually all hi-fi cartridges by means of precisely engineered adapters which simplify installation and provide proper stylus pressure.

This tone arm is a quality companion to the PK-100 with matching finish. Shpg. wt., 2 1/2 lbs.

PK-90 Net **15.95**



NEW! HIGH FREQUENCY TWEETER WITH ACOUSTIC LENS

DIRECT IMPORTATION
MAKES THIS PRICE POSSIBLE!

- FREQUENCY RESPONSE FROM 2000 CPS TO BEYOND AUDIBILITY
- LOUVERED ACOUSTIC LENS FOR UNIFORM SOUND DISPERSION
- HANDLES 25 WATTS OF POWER
- PRICED EXCEPTIONALLY LOW

14.95

New high frequency tweeter featuring a louvered acoustic lens for uniform sound dispersion and capable of handling up to 25 watts of distortion-free power. The directional tendency of high frequency notes is overcome by the natural wide dispersion angle of the short horn and the acoustic lens which disperses and radiates the high notes smoothly throughout the entire listening area. The lens is detachable for panel mounting, with a separate base for the tweeter furnished for external mounting where desired. Aluminum voice coil has 16 ohms impedance. Size: 4 1/4" long x 3" diameter, lens extends 2 1/2". Requires a crossover network, preferably one with a level control, such as the LN-2. With full instructions. Shpg. wt., 5 lbs.

HW-7 Net **14.95**

METAL-CASED CONE TYPE HI-FI TWEETER FREQUENCY RESPONSE 2000 - 16,000 CPS HANDLES 20 WATTS OF POWER

Highest quality cone type high frequency tweeter having a range from 2000 to 16,000 cycles. Especially efficient at higher end of audio spectrum where other cone type tweeters tend to lose clarity and volume. Entirely closed in a metal case with a base so that it can stand by itself or be mounted on a flat surface with mounting bracket supplied. Rated to handle 20 watts of power. A crossover network is required; the Lafayette LN-2 is ideal. Voice coil impedance 8-16 ohms. Size: 3 1/8" x 2 1/8" x 3" Diam. Shpg. wt., 3 lbs.



5.95 Net

HK-3 Net **5.95**

CROSSOVER NETWORK CAPACITIVE-INDUCTIVE NETWORK WITH CROSSOVER AT 2000 CPS BUILT-IN LEVEL BRILLIANCE CONTROL



8.75

The frequencies above 2000 cycles are channeled to the high frequency tweeter by means of the high-Q inductance and capacitance comprising this efficient crossover network. The highs and lows are brought into acoustic balance by means of a continuously variable level-brilliance control. Control has a 2 1/2 ft. long cable for remote mounting. Network matches 8-16 ohm speakers with insertion loss reduced to a minimum. Enclosed in metal case 6" L x 2 1/2" H x 2 5/8" D. With full instructions. Shpg. wt., 5 lbs.

LN-2 Net **8.75**

3 WAY CROSSOVER NETWORK

Carefully designed and engineered to Lafayette's own specifications. Insertion loss is well below the acceptable minimum. Crossover is at 350 and 5000 cycles. Permits full enjoyment of any 3 way system. Properly balances woofer, mid range speaker and tweeter inputs. Complete with 2 continuously variable "presence" and "brilliance" controls for tonal adjustment and full instructions. 8" L x 3 1/4" H x 2 3/4" W. Shpg. wt., 7 lbs.



14.95

LN-3 Net **14.95**

LAFAYETTE MATCHED HIGH FIDELITY PHONO SYSTEM



Reg. Value
~~158.55~~
SALE!
119.50

G.E. Triple Play
Diamond Sapphire Styli

RC-121

SK-58

Nothing

Finer
At
This
Price

NEVER—in the annals of HIGH-FIDELITY has a phono system of this quality—at this price—been offered. A Lafayette "best buy" system designed around the new Lafayette LA-59 amplifier. The performance of this Phono system surpasses the most critical requirements of music lovers. Twenty-four combinations of record equalization provide an almost endless variety of tone compensation to match varying recording characteristics. This system includes the famous Garrard RC-121 "Renown" 4 speed automatic and manual record changer, LAFAYETTE LA-59 18 watt amplifier with features found only in the most expensive amplifiers. G.E. triple-play—turnover cartridges with genuine G.E. DIAMOND SAPPHIRE STYLI, AND LAFAYETTE SK-58 12" coaxial HI-FI speaker. All units are supplied with plugs, jacks and prepared color-coded interconnecting cables for quick easy installation. For 110-125 volt, 60 cycle AC. Shpg. wt. 50 lbs.

HF-154—Complete Phono System Net **119.50**

Lafayette
Radio
DEPT RG2

165-08 LIBERTY AVE.
JAMAICA 33, N. Y.

NAME _____

ADDRESS _____

CITY _____

ZONE _____

STATE _____

SEND
FREE
LAFAYETTE
CATALOG

CUT OUT AND MAIL TODAY!

GET YOUR NEW

1957 *Radio Electronic* MASTER

(21st EDITION)

- What product best fills your needs?
 - What does it look like?
- How does it compare? • Who makes it?
 - What does it cost?

Up-to-the-minute answers to all these questions are in The MASTER. Containing four to five times the product coverage of any other buying guide—there is no catalog like it. It is 350 factory-prepared catalogs in one bound volume.

1546 PAGES...

the world's largest electronic parts catalog!



ONLY **\$295**
from parts distributors

SERVICEMEN, DEALERS! Buy, sell and bill direct from The MASTER. It shows list prices!

HAMS, EXPERIMENTERS! At your fingertips, those hard-to-get items found only in The MASTER.

HI-FI FANS! Pre-select components in your home. Hear them demonstrated at your dealer.

RESEARCH MEN! Specify, design more rapidly... all the latest data in one bound volume.

1546 PAGES OF THE MOST CURRENT DATA ON:
TUBES • TEST EQUIPMENT • CAPACITORS
CONTROLS • TRANSFORMERS • RELAYS
ANTENNAS • HI-FI • RECORDING & PA
WIRE & CABLE • RESISTORS • KITS, ETC.
• Over 125,000 items • Complete descriptions • Specifications—Prices
• 11,250 illustrations • Fully indexed
• 8½ x 11", 6 lbs.

No matter what electronic component you look for
**YOU FIND IT FASTER
IN THE MASTER**

Get the 1957 edition from local parts distributors — or write for list.

THE Radio-Electronic MASTER
60 Madison Avenue, Hempstead, N. Y.

New Tube Tester Data

Owners of Triplet tube checkers will want this list of settings for more than 30 new tube types.

TRIPLETT MODEL 3413

Tube Type	Knobs			Lever Position		Tube Type	Knobs			Lever Position	
	A Cir	B Fil	C Load	Up	Down		A Cir	B Fil	C Load	Up	Down
2B3	3	2	100	0	2	8CM7 Test 2	3	7.5	24	67	35
(Good Tube Reads 10)						9AU7	2	5	26	12	345
4BQ7A(Adapt.BY)2	4.2	20	12	34		9AU7 Test 2	2	5	26	67	458
4BQ7A(Adapt.BY) Test 2	2	4.2	20	67	48	10C8	1	7.5	22	12	35
5BE8	2	5	20	12	35	10C8 Test 2	2	7.5	21	678	59
5BE8 Test 2	2	5	20	679	358	12AB5	3	12.6	23	1368	57
5BQ7A	2	5	22	12	34	12AC6	1	12.6	21	256	47
5BQ7A Test 2	2	5	22	67	48	12AD6	1	12.6	32	6	12357
5BZ7	3	5	20	12	34	12AD6 Test 2	1	12.6	32	567	123
5BZ7 Test 2	3	5	20	67	48	12AE6	1	12.6	22	17	23
6BA8A	2	6.3	24	23	14	12AE6 Test 2	1	12.6	40	6	23
6BA8A Test 2	2	6.3	21	789	46	12AE6 Test 3	1	12.6	40	5	23
6BU8	1	6.3	20	2367	15	12AJ6	1	12.6	20	17	23
6BU8 Test 2	1	6.3	20	2789	15	12AJ6 Test 2	1	12.6	38	6	23
6BV8	2	6.3	20	23	15	12AJ6 Test 3	1	12.6	38	5	23
6BV8 Test 2	1	6.3	60	9	57	12AL8	1	12.6	22	1	59
6BV8 Test 3	1	6.3	60	6	58	12AL8 Test 2	1	12.6	38	26	357
6BY8	2	6.3	26	1278	59	12BL6	1	12.6	20	156	247
6BY8 Test 2	2	6.3	22	6	35	12BW4	4	12.6	20	7	59
6CM7	2	6.3	22	18	59	12BW4 Test 2	4	12.6	20	1	59
6CM7 Test 2	2	6.3	24	67	35	12CT8	2	12.6	22	12	34
6DG6	3	6.3	63	34	1578	12CT8 Test 2	3	12.6	16	678	59
6DQ6GA	3	6.3	17	450	78	12F8	1	12.6	21	238	479
8AU8	2	7.5	22	23	14	12F8 Test 2	1	12.6	37	1	47
8AU8 Test 2	2	7.5	22	789	46	12F8 Test 3	1	12.6	37	6	47
8BA8A	1	7.5	20	23	15	15A8	2	12.6	27	38	12
8BA8A Test 2	2	7.5	21	789	65	15A8 Test 2	2	12.6	24	450	26
8BH8	1	7.5	19	23	15	17AX4	3	19.6	20	5	38
8BH8 Test 2	2	7.5	21	789	56	17C5	3	12.6	17	2567	13
8CG7	2	7.5	25	12	34	17DQ6	3	12.6	17	450	78
8CG7 Test 2	2	7.5	25	67	48	17H3	3	19.6	21	38	15
8CM7	2	7.5	22	18	59	18A5	2	19.6	23	158	37

Set line control so meter reads 48 on line test

Make Money! You can sell these at a profit.

RCA VICTOR Combination Portable RADIO - "45" PHONOGRAPH

Only Olson dares to cut the price so low. Cash during our sale. This famous RCA Victor Portable Radio-Phonograph is completely battery powered and works anywhere.

LOOK AT THESE FEATURES
Plays all 45 RPM discs. Constant speed motor runs on 4 flashlight batteries. Radio is super-loud, iron-core IF with automatic volume control, powered by one A-B pack, oversize "RCA Victor Golden Throat" Speaker system. Built-in Ferrite antenna pulls in distant stations full range 540-1600 KC. Lightweight RCA tone arm with Sopotone cartridge and precision tip needle. Record storage compartment under lid. Size 5 1/2" h. 11" w. 12" d. Carrying handle folds into grille.
A-B Battery Pack—RCA VSO-64 or Burgess 4T260. Stock No. BA-38. Ea. \$3.85
FLASHLIGHT CELLS, 4 required RCA VSO-36. Stock No. BA-23. 10c

Model 6BY4 "Golden Throat"
Battery Operated

Reg. Price \$29.88
\$59.95



3 for \$88

Stock No. RA-263

Approx. Shpg. Wt. 8 lbs.

SHAV-PAK

Operates 115 V Shavers in Cars, Trucks, Boats, Planes



Your Choice

\$7.97

RA-264 input 6 Volt
RA-265 input 12 Volt

3 for \$23.00

Especially designed to run all makes and models of 115 volt shavers by merely plugging inverter plug into cigarette lighter receptacle. Delivers 115 Volts 60 cy. 15 watts. Size 4 x 2 1/2 x 2 3/4". Approx. Shpg. Wt. 6 lbs.

45 RPM

RECORD PLAYER

Ready To Plug-in



\$16.38

Stock No. RP-36

Here's a small, compact fully automatic turner only 10" w. x 7" d. x 7" h. Plays up to 12-7" records with one loading. Equipped with low pressure tone arm. Mounted in smooth working bearing. Has reject button. Cartridge is famous 1.5 volt Ronette with sapphire stylus. Works with any radio, amplifier or TV. Operated on 110 Volts AC 60 Cy. Complete with base, line & phono cords. Approx. Shpg. wt. 5 lbs.

POWERFONE WALL TELEPHONE

Stock No. PH-3



\$3.93

Pair

3 pair for \$11.00

Two station telephone set. Talk back and forth for up to one mile. Powerfone is guaranteed to give as good tonal quality as your telephone. Push button and push button on each instrument. Also has push-to-talk button. Sensitive enough to hear a whisper. Uses flashlight batteries. Complete with 2 batteries, 2 wall hangers, and 50 ft. of wire. Approx. Shpg. Wt. 3 lbs.

Extra 2-conductor cable for above
Stock No. W-103 100 ft. \$1.19
Stock No. W-104 250 ft. \$2.50

Crystal Hearing Aid EARPHONE

\$1.95

Stock No. PH-2
3 for \$5.50



High impedance. Weighs less than 1/2 oz. 3 ft. cord. Pleasant colored, inconspicuous when worn. Works well with crystal set.

DOUBLE HEADSET

Stock No. PH-6



\$1.95 PAIR
3 pairs \$5.60

2000 ohm impedance. Large magnet, removable bakelite caps. Adjustable steel headband, 3 1/2 ft. braided cord, standard phone tips.

GENERAL ELECTRIC DISPLAY MOTOR



Built-in Drive
7 RPM
110-120 Volt AC

Stock No. MO-10
\$3.87

3 for \$10.00

Originally designed to operate a rotating shelf refrigerator display. Develops sufficient power to handle quite large loads. Power output shaft 3/16" dia. has 3/4" dia. pulley attached also additional pulley plus a spring pulley belt. Perfect for operating any remote control device such as an indoor antenna. Supplied complete in original boxes including a 3-way AC receptacle & 5 ft. AC cord. Approx. Shpg. Wt. 2 lbs.

Portable Transistor RADIO KIT

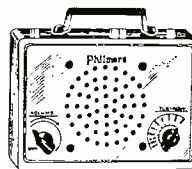

LIST PRICE \$20.00

\$12.94 EACH

Stock No. KB-38

Complete with loudspeaker

Build a powerful radio which will provide excellent loudspeaker reception over the entire broadcast band. Circuit consists of diode type detector plus dual transistor audio stages. Feature built-in high-Q loop antenna and oversized FM speaker. Housed in a clear plastic case with convenient carrying handle, over all size: 7 1/2" x 5" x 1 1/2". Kit supplied complete with 2 transistors, germanium diode, plastic cabinet and all other necessary components, ready to assemble. Full illustrated detailed instructions make assembly easy and fast. Ideal for picnics, beach parties, football-baseball games—anywhere that electric power is not available. Very low cost, battery lasts and lasts. Approx. Shpg. Wt. 3 lbs.
BA-37 Battery for above. 77c

ATTENTION MANUFACTURERS: If you have large quantities of surplus electronic parts you wish to sell or write OLSON at once. We pay top prices!

SEND FOR NEW FREE CATALOG

HOW TO ORDER

Mail your order to 280 E. Market St., Akron 8, Ohio. Send remittance with order. Add for postage 5c for each dollar's worth ordered—10c for each dollar's worth if you are more than 1000 miles away. OLSON REFUNDS EVERY CENT NOT COLLECTED. Or send no money—we'll ship C.O.D. and you pay mail or expressman for merchandise and postage. ALL MERCHANDISE 100% GUARANTEED. PLEASE—MINIMUM ORDER \$5.00.

OLSON BARGAIN STORES IN:
CHICAGO—623 W. Randolph St.
CHICAGO—123 N. Western Ave.
CLEVELAND—2020 Euclid Ave.
PITTSBURGH—5918 Penn. Ave.
MILWAUKEE—423 W. Michigan
BUFFALO—711 Main Street

Continuous Play TAPE MAGAZINE

Repeats Recorded Messages Endlessly



Reg. Price \$12.50

\$1.89

Stock No. X-643

3 for \$5.00

Makes and plays recorded messages endlessly. Can be erased and re-recorded as many times as desired. Brand new. Offered at this low, low price because we can't supply mounting hardware. Can easily be mounted on recorder with homemade bracket. Repeat messages in stores, carnivals, rehearsals, etc. Each magazine is loaded with 100 ft. of finest double coated tape. Will record and play both sides consecutively, 10 minutes at 3 3/4 IPS or 5 minutes at 7 1/2 IPS. Approx. Shpg. Wt. 2 lbs.

Sessions TIMER CLOCKS

Reg. \$6.45
Stock No. X-558

\$2.94 3 for \$8.75



Turns on TV sets, radios and appliances etc., at any time within a 12 hour period. Connect it to a radio, set it the night before and wake up to music. It will also turn on a lamp or start an electric coffee maker going. Sweep second hand. Mounts in a 3 1/2" dia. hole. Operates on 110-120 volt 60 cy. AC. Approx. Shpg. Wt. 1 lb.

Deluxe Model With "Lullabye Switch"

Reg. \$7.75 List \$3.55 3 for \$10.00

Contains all the features of above plus a built-in "Lullabye Switch" lulls you to sleep with music, shuts off the radio and starts again at any preset time. For 110-120 Volts 60 cy AC. Approx. Shpg. Wt. 1 lb.

Columbia PHONOGRAPH

PLAYS 33 1/3, 45 AND 78 RPM
LOOK AT THIS TERRIFIC DEAL

Columbia Model 412 Phonograph. \$29.95
Set of 5 Columbia 45 Extended Play Records. 7.50

Beautifully finished two-tone portable carrying case. Tone arm is Columbia with turn-over Ronette cartridge with dual sapphire needles. Automatic pop-up adapter for 45 RPM discs. Plays all 7, 10, and 12" records at 33 1/3, 45 and 78 RPM.
Powerful Alnico 4 speaker. High power amplifier with volume and tone controls. Case size 12 x 10 x 5 1/4". 115 Volt AC 60 cycle. Brand new. Factory sealed cartons. The 5 Columbia extended play records feature such artists and orchestras as: Xavier Cugat, Eddie Condon, Rampart Street Fiddlers, Liberate, Art Van Damme, Jimmy Boyd, Jean "Toots" Thielmans. Selections, 20 in all, range from popular to classical.



Stock No. AS-243

\$21.88

3 for only \$63.00

Approx. Shpg. wt. 11 lbs.

WEN SOLDERING GUN AND 500 RESISTORS



SAVE \$6.12

Stock No. AS-199

Both For

\$7.33

HERE'S HOW YOU SAVE
WEN 100 Watt Reg. Price
soldering Gun. \$5.95
Kit of 500 Resistors. \$7.50
TOTAL. \$13.45
Once-a-Year Discount
count. \$6.12
Your Cost. \$7.33

Famous Wen 100 Watt model soldering gun delivers full soldering heat seconds after the trigger is pulled, cools fast too. Brand new in factory sealed cartons. Operates on 115 VAC. Resistor kit contains 500 pieces, ALL POPULAR. Every resistor brand new and marked with value and tolerance. Range from 50 ohms to 20 megohms, 1/2, 1 and 2 watt sizes, 5%, 10% and 20% tolerances. All with long tinned leads. Don't miss the tremendous deal. Approx. Shpg. Wt. 5 lbs.

Musical Instrument MICROPHONE



Reg. \$13.50

\$5.11

3 for \$15.00

Stock No. M-107

Can be clipped onto any guitar, violin, cello, piano, etc., & connected to any amplifier or tape recorder. Will deliver outstanding solo amplification and capture the full, rich, natural brilliance of the instrument. Equipped with 25 ft. cable and plug. Approx. Shpg. Wt. 1 lb.

3-SPEED PHONO MOTOR AND TONE ARM



Worth \$9.50

You Get Both For

\$5.78

STOCK NO. AS-205

Genuine Monarch (Made in England) 3-speed, 33 1/3, 45, and 78 RPM motor and 8" turntable. Handy lever switches from one speed to another. Rim drive, rumble free. Tone arm is the famous Webster with Turn-over crystal cartridge. 3 volt output. Equipped with 3 mil and 1 mil osmium tipped needles, 50-7000 cps. Arm is counter-balanced. Shpg. Wt. 5 lbs.

JUNEERO Miniature MACHINE SHOP

The Made-in-England Marvel Bends, Shears and Punches Flat Strip Metal



Stock No. TL-125

\$3.93

Approx. Shpg. Wt. 4 lbs.

Bends and threads rod to complex specs. Make your own hard-to-get brackets for condensers, relays, and other resistors, transformers, etc. EASILY. Complete with stock of strip steel and instructions. The Juneero multi-purpose tool is a correctly designed and engineered device for making, modeling and repairing metal. Any angle bracket with complex bends, holes and slots can be made in minutes. The Juneero is equipped with cutting shears for strip metal, cutting shears for rod, bending jig for rod, bending die for making angle brackets, a punch and a vise. Size: 10-4x9". Comes complete with a good supply of strip steel for making any bracket.

Deluxe Model
Same as above plus a stock of rod material and a thread cutting die. Stock No. TL-128 \$5.11

OLSON RADIO WAREHOUSE

280 E. MARKET ST. AKRON 8, OHIO

lator that locks elements in place and a sure-grip mast clamp.

STYLED INDOOR ANTENNA

Midwest Naturlite Co., 6651 N. Clark St., Chicago 26, Ill., combines pleasing appearance and performance in an indoor antenna with the new "Decor-Tenna." Rotary tuning per-

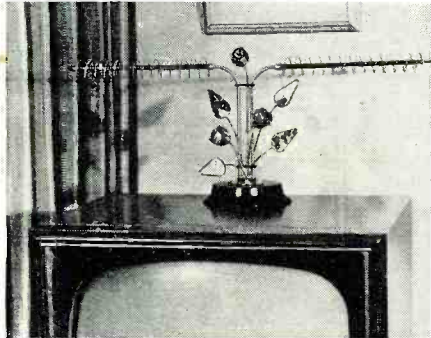

mits reception on v.h.f. and u.h.f. Available in black and gold or black and silver, the floral arrangement consists of metal-edged transparent foliage into which natural particles have been pressed for effect.

BUSINESS OUTLOOK

Snyder Mfg. Co. of Philadelphia, Penna., is looking forward to an upswing in business for 1957 over 1956. One of the factors in an anticipated rise of over 25 per-cent, opines president Ben Snyder, is the belief that color TV will begin to make itself felt before the year is out. The continued sale of second and even third sets to present one-set families, he feels, will also continue. In addition, improved antenna designs will create new markets and promote replacements of marginal antennas. On his recent tour of Europe, Mr. Snyder expressed the opinion that, if the TV market opens up there, a bonanza will result for American manufacturers of receivers, antennas, and other products. He feels that a better product can be made here to undersell European equipment.

LOWEST ANTENNA

JFD Mfg. Co., Inc., 6101 16th Ave., Brooklyn, N. Y., reports a fringe-area installation story with a reverse twist.



Accustomed to hearing reports of unusual height in distant antenna locations, officials were apprised of a "Col-

March, 1957

What does the future hold for you?

Electronic Technicians

If you seek further training or education, Hughes, located in sunny Southern California, is the place for you. As the West's leading center for advanced electronics, Hughes offers its electronic technicians the opportunity to work on some of the most advanced equipment in existence. On joining the organization you will participate in programs which provide everything from "on the job" training to specially designed Hughes courses.

Also, you may take advantage of the Hughes-sponsored evening courses offered in all of the nearby universities. Every year dozens of Hughes technicians receive their degrees!

The all-around experience and education you receive will qualify you to be a leader in the future age of electronics.

Hughes offers you top pay! And chances are, Hughes will pay all of your moving and travel expenses. Find out more about what Hughes can now offer you.

WRITE TODAY

For further information concerning these opportunities at Hughes, write to Mr. John C. Bailey at the address below.

Scientific Staff Relations

HUGHES

RESEARCH AND DEVELOPMENT LABORATORIES

HUGHES AIRCRAFT COMPANY, CULVER CITY, CALIFORNIA

FIELD ENGINEERS:

HERE'S THE GOOD WORD—



Bendix Radio

IS CONTINUING ITS RAPID EXPANSION AND NEEDS YOU!
 Bendix Radio, the leader in its field, has numerous, excellent opportunities for Field Engineering Personnel for both U.S. and overseas assignments. You will be responsible for the installation, overhaul and maintenance of long-range Bendix radar equipment.

ACT NOW! YOU'LL OBTAIN THESE IMPORTANT ADVANTAGES:

- ★ The prestige of representing the leader in its field.
- ★ Opportunity for professional development & advancement.
- ★ Excellent salary.
- ★ Overseas allowance.
- ★ Many other company benefits
- ★ Field allowance.
- ★ Relocation expenses.

It is preferable that you have had a minimum of two years college, plus at least four years engineering experience in radar or communications systems.

Send resume to: MR. O. A. BOWMAN
 Field Engineering
 Dept. R

Bendix Radio

DIVISION OF BENDIX AVIATION CORP.
 BALTIMORE 4, MARYLAND

antenna" installation in Death Valley, California that is believed to be the lowest antenna on record in this country. The "Star-Helix Colortenna" is on the roof of a home at Furnace Creek Ranch, 178 feet below sea level. Andy Ambrose, TV dealer who made the installation, says that all channels are received from Los Angeles despite the distance of 180 air miles and the depth of the valley. Other installations in the region are also reported as performing well.

INDOOR ALL-BAND ANTENNA

Channel Master Corp., Ellenville, N. Y., has added Model 3905 to its "Showman" indoor antenna line. The addition of a short folded dipole at the rear of the antenna enables reception across the u.h.f. band, as well

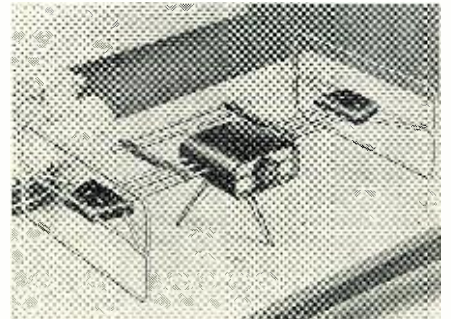

as in the v.h.f. band picked up by conventional "Showman" units. In u.h.f. reception, the elements normally used to receive v.h.f. signals act as parasitic reflectors. The new antenna also is recommended by the manufacturer for use with FM tuners, since it is also effective from 88 to 108 mc.

LIGHT CRANK-UP TOWERS

Alpar Mfg. Co., Redwood City, California, readies a shipment of aluminum crank-up towers to the New Zealand government. Other customers include individuals and governments in Europe, Africa, South America, Canada, Mexico, the Far East, Hawaii,

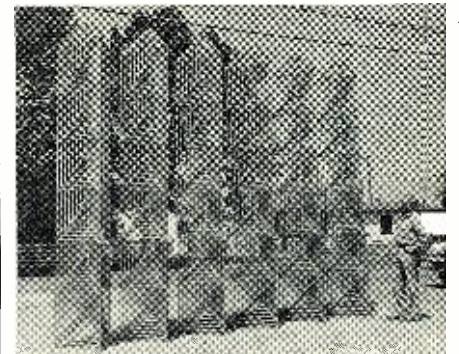

and Alaska. Similar towers are sold to the U. S. government for use in research, survey, and communications purposes. Shown at the minimum height of 12 feet, these weather-resistant towers can be cranked as high as 82 feet. When a storm threatens or antenna repair is necessary, towers can be lowered without the need to leave the ground.

COYNE
 TRAINS YOU
 IN SPARE TIME
 AT HOME

COYNE QUALITY TRAINING AT LOWEST COST

TELEVISION

RADIO-COLOR TV

Only from famous COYNE do you get this modern up-to-the minute TV Home Training. Easy to follow instructions—fully illustrated with 2150 photos and diagrams. Not an old Radio Course with Television tacked on. Includes UHF and COLOR TV. Personal guidance by Coyne Staff. *Practical Job Guides* to help you EARN MONEY QUICKLY IN A TV-RADIO SALES AND SERVICE BUSINESS—part time or full time. COSTS MUCH LESS—pay only for training—no costly "put together kits."

SEND COUPON FOR FREE BOOK
 SEND COUPON BELOW for Free Book and full details including EASY PAYMENT PLAN. NO COST OR OBLIGATION—NO SALESMAN WILL CALL.

B. W. COOKE, Jr., Pres. **COYNE ELECTRICAL SCHOOL** FOUNDED 1899

A TECHNICAL TRADE INSTITUTE OPERATED NOT FOR PROFIT
 500 S. Paulina Dept. 37-HT5 Chicago 12, Illinois

COYNE ELECTRICAL SCHOOL
 Television Home Training Div.
 500 S. Paulina St., Chicago 12, Ill., Dept. 37-HT5

Send FREE BOOK and details of your Television Home Training offer.

Name _____
 Address _____
 City _____ State _____

COMMUNICATIONS RECEIVER NATIONAL

RBL-5 (Govt Cost \$600)
 Mfd for U. S. Navy & Merchant Marine, frequency 15-600 KC, 6 bands. Cover distress band, beacons, ships at sea, etc. Use phones or speaker. BRAND NEW with tech. manual. . . . **\$59.95**

CAPACITOR ANALYZER & RESISTANCE BRIDGE—Capacity range 10 Mmf-100 Mfd. Resistance bridge 1 Ohm-10 Meg. Sloping front panel. Eye Tube & meter indicator **\$22.50**
 12x10x10; 12 lbs. used but OK.

TEST SET—WESTERN ELECTRIC
 #CALA. 60 ACP (Govt. Cost \$100.00) 3" Rd. 100 Microampere Meter Set in center of case—4 sets dual W. E. binding posts to provide outputs for measuring following ranges ±1% — 3V; 300 V; 600 V; 100 Microamps; 3 Mils.; & —300 V. Housed in Navy case w/carry handle & cover—8x8x4. BRAND NEW. . . . **\$14.95**

COLLINS TRANSCEIVER—MODEL MBF
 —115 V. ACDC—14x7x8—25 lbs. 60-80 MC—4 type 28D7-P.P. Parallel output, with all tubes (28). Good Cond. . . . **\$19.95**

ARC-5 TRANSMITTERS
 3-4 MC—Exc. cond. w/tubes **\$5.95**
 5-3-7 MC—Exc. cond. w/tubes **4.89**

ARC-5 RECEIVER
 3-6 MC—Autotune Head—w/tubes **\$6.95**

MIKE X FORMER—Mfd by Collins for TC S/Transcr. shielded, cased, Ratio—75-125,000 Ohms CT, BRAND NEW **\$1.29 ea., 5 for \$5.00**

807W/5933—Ruggedized version of 807, regular net 12.50 New sylvania boxed—\$1.59 ea. —dozen **\$15.00**

MINIATURE METER—0-200 Microamps. Full scale—1 1/2" sq. new mfd by DeJur with dial. . . . **\$4.95**
 Butterfly cond. assbly—300-1000 MC—TN-18

Toggle S W—SPST—6 A.—115 V. . . 3 for **\$4.95**
 Toggle S W—DPDT—6 A.—115 V. . . 2 for **\$1.00**
 2 MFD B'Tub—600 VDC—S. T. . . . 3 for **\$1.00**
 7 Pin. Min. Socket—1/2 shield—Mica Cinch—8 for **\$1.00**, 100 for **\$10.00**

New, Nested.
BRAND NEW JAN TUBES
 12SJ7—2 for **\$1.00** 6BA6—3 for **2.00**
 12SL7—2 for **1.00** 6U6—2 for **1.00**
 6J5—2 for **1.00** 5D21—3 for **4.95**
 VR105—3 for **2.00** 726B— **14.95**
 3A5—3 for **1.00**

ALL MDSE FOB NYC
REX RADIO SUPPLY
 88 Cortlandt Street New York 7, N. Y.

Sales Aids

RCA TELEVISION FILM

A new documentary film, presented by RCA, and produced by the William J. Ganz Co., traces the progress of TV from its inception to the present development and expansion of color TV.

Entitled "The Story of Television," the film unfolds on the theme that the signature of every century has been its skyline—from the Sphinx to the modern American skyline with its TV antennas. By means of animation, transmission and reception is explained with simplicity and directness. The film covers historical TV events, and finally describes how color works.

Copies of the movie are available on a loan basis through the Institute of Visual Training, 40 E. 49th St., New York 17, N. Y. for showings before civic groups, community organizations, educational institutions, etc.

The 27 minute film is available without cost to the exhibitor, except for a mailing charge.

* * *

TUBE PACKAGING PLAN

A new packaging plan for receiving tubes in the electronic products re-

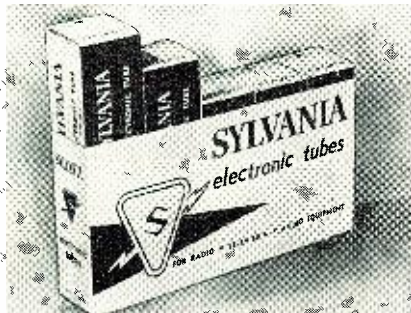

newal line has been introduced by Sylvania Electric Products Inc.

Available in individual carton and in "five-pack" form, this new packaging has been developed to assist the distributor in handling and merchandising the electronic tube line.

Both packages use a colorful black and yellow design featuring the familiar flashing "S" insignia.

* * *

STORE WINDOW DECAL

Rohn Manufacturing Co., of Peoria, Illinois, is offering a new four-color store window and general use decal to its dealers, service technicians, and distributors.

The 9½ by 6½-inch decal bears the message, "We recommend and sell Rohn 'Superior Design' TV Communications Towers and Accessories."

For further information, see the firm's representatives or write direct to the company at 116 Limestone, Bellevue, Peoria, Illinois.

-50-

HOBBYISTS...EXPERIMENTERS!

ELECTRONIC EXPERIMENTER'S HANDBOOK



Compiled by the Editors of POPULAR ELECTRONICS

LEARN HOW TO BUILD:

- Your Own AM Hi-Fi Tuner
- Thermistor Fire Alarm
- Electronic Gardening Gadgets
- A Device That Kills TV Commercials
- Electronic Toys
- Geiger Counter
- Transistorized Light Meter
- Your Own Lie Detector
- PLUS DOZENS OF OTHER HANDY, EXCITING ELECTRONIC DEVICES

BUY YOUR COPY OF THE
ELECTRONIC EXPERIMENTER'S HANDBOOK

ON SALE SOON
AT YOUR FAVORITE NEWSSTAND!

Price: \$1.00

Ziff-Davis Publishing Company
366 Madison Avenue
New York 17, New York



Here's how to GET MORE WORK OUT OF YOUR Oscilloscope!

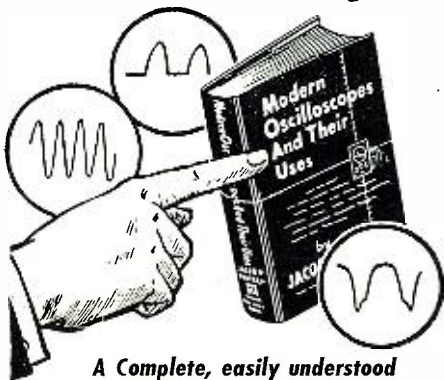

A Complete, easily understood guide to using the handiest service instrument of them all

MODERN OSCILLOSCOPES AND THEIR USES

By Jacob H. Ruiter, Jr.

Enlarged 2nd Edition

... contains the latest data ... everything you need to know about 'scopes!

MORE THAN 30 NEW PICTURES

... plus 50 more pages on use of 'scopes in Color TV servicing ... Industrial Electronics ... Teaching ... even in Atomic Energy work.

It gets right down to "brass tacks" in explaining how oscilloscopes operate. Then you learn exactly how to use them in lab work and on all types of AM, FM and television service—from locating troubles to handling tough realignment jobs.

'SCOPES ARE "GOLD MINES" ... When You Learn to Use Them Right!

Each operation is explained step by step. You learn to determine just where and how to use the 'scope on specific jobs; how to make connections and adjust circuit components; how to set the controls; and HOW TO ANALYZE OSCILLOSCOPE PATTERNS fast and accurately.

370 illustrations including dozens of pattern photos make things doubly clear.

No other type of specific service training can mean so much to you in boosting your efficiency and earning power! Send coupon NOW for 10-day FREE examination!



'SCOPE EXPERTS get better jobs ... bigger pay!

PRACTICE 10 DAYS—FREE!

232 Madison Ave., New York 16, N. Y. Dept. RN-37, RINEHART & COMPANY, Inc.

Send MODERN OSCILLOSCOPES AND THEIR USES for 10-day FREE EXAMINATION. If book is satisfactory, I will then send you \$6.50 promptly in full payment. If not, I will return book postpaid in good condition and owe you nothing. (SAVE! Send \$6.50 cash with order and we pay postage. Same 10-day return privilege with money refunded.)

NAME

ADDRESS

CITY, ZONE, STATE

OUTSIDE U.S.A. \$7.00 cash only. Money back if you return book within 10 days.

Within the Industry (Continued from page 32)

dent, properties; and **AUSTIN C. TAIT**, director of industrial relations ... **STANLEY PAIGE** has been appointed to the position of Great Lakes district manager for the audio division of *Ampex Corporation* ... *General Radio Company* announces the election of **LAWRENCE H. PEXTON** as treasurer, and **JOHN D. QUACKENBOS** as secretary ... The appointment of **HENRY F. ARGENTO** as vice-president and general manager, government and industrial division, *Philco Corporation*, has been announced. He succeeds **JAMES D. McLEAN**, resigned ... **WILLIAM T. BUSCHMANN** has been named electronic products merchandising manager for *Sylvania Electric Products Inc.* ... The appointment of **WILLIAM E. KRESS** and **JOHN L. UTZ** to the newly created position of market manager was announced by *Philco Corporation* ... **JAMES A. FINIGAN, JR.** has been appointed general sales manager for electronic sales of the *Remington Rand "Univac" Div. of Sperry Rand Corporation* ... **HAROLD S. GENEEN**, executive vice-president of *Raytheon Manufacturing Company*, has been elected a director of the firm ... *Simpson Electric Company* has appointed **WILLIAM R. JOHANSEN** to the post of assistant sales manager ... **WILLIAM L. LIEBERMAN** has been appointed to the post of quality control director of *The Pentron Corporation* ... *Air Associates, Inc.* announces the appointment of **LORIAN W. WILLEY** as vice-president ... **DONALD C. McDONALD** has been appointed to a new position of director of engineering by the *Friez Instrument Div. of Bendix Aviation Corporation* ... **JOSEPH C. WORTH** has been named director of the *Laboratory for Electronics, Inc.*, Special Products Division ... **GUY WITTER**, member of *Dean Witter & Co.*, has been elected a member of the board of directors of *Altec Companies, Inc.* ... *Utah Radio Products Corp.* has announced the appointment of **WILLIAM L. ALLEN** as industrial sales manager ... **GAIL S. CARTER** has been elected to the board of directors of *Merit Coil & Transformer Corporation*. Also, he has been appointed assistant to the president of the firm ... **HUGH P. MOORE**, board chairman of *Lerco Electronics, Inc.*, has been elected chairman of the Los Angeles council of the West Coast Electronic Manufacturers Association. He has been a director of the association for the past four years ... **RICHARD M. OSGOOD** has been appointed manager of the *Waltham Laboratories of Sylvania Electric Products Inc.* ... *Philco Corporation* has named **JOSEPH H. GILLIES** to the post of executive vice-president, operations; **LARRY F. HARDY**, executive vice-president, consumer products; and **DR. LESLIE J. WOODS**, executive vice-president, research and engineering. These are newly created positions ... **DR. ERWIN F. LOWRY**, manager of the research engineering

NOBODY ... but nobody who likes fun should forget to send in his order for this RELAY THAT THINKS!

Sigma 80030 is rated to snap and stay into either one of its two contact positions when you momentarily send 900 uA through its 5,000 ohm coil. But the sample we tested worked at only 420 uA! Which is only 2.1 volts d.c. Moreover this hermetically-sealed octal plug-in SPDT relay senses the direction of current through its coil! If you reverse the polarity, it snaps to the other contact. The large silver contacts are conservatively rated at 2A., 28 volts d.c. Lots more at act! So if you put this relay in a bridge, it will play all kinds of tricks for you. We send our circuits. Poor Old Uncle paid \$11.36 each! Ship, wt 1 lb.
BRAND NEW. Cat. No. 1306RVI4RN. Only \$2.95
BUGGLARS BEWARE! With this relay on the job your number is up!
FIREMEN, BEWARE! This relay will put you out of work!
CONTROL ENGINEERS! Show this ad to your boss. We've got a good supply of these relays right now.

IF YOU NEVER HEARD OF AN ELECTROSTATIC RELAY, YOU WILL IF YOU SEND FOR OUR NEW BULLETIN ON RELAY BARGAINS!

MATCHED MINIATURE METERS

Gorgeous new line—not surplus! Only 1 3/4" square. 1 1/2" hole. Handsome black calibration on white face. 2% accuracy. D'Arsonval movements. Guaranteed.

DC Microamperes: 0-50	\$5.95	0-100 or 100-1000	\$5.50	0-200	\$4.95	0-500
DC Milliamperes: 0-1	0-100	0-200	0-300	0-500	any one	\$3.50
DC amps: 0-10	\$3.95	RF amps: 0-3	\$5.95	AC Volts: 0-15 or 0-150	either one	\$3.95

COMMUNICATIONS RECEIVER

RCA's CRV-46151 6-tube superhet. 195 Kc thru 9.05 Mc. Very sensitive. Includes AVC, sharp and broad selectivity. Has AVC-MVC switching and BFO. You may replace the dynamotor with an AC power supply. Dope sheets and schematics included. Excellent cond. Shpg. wt. 30 lbs.
Cat. No. 3806RE3RN. Only \$19.95
Mounting Rack \$2.50

FREQUENCY METER AND TEST OSCILLATOR!

115 V., 50-800 cy. power supply. In frequency section, crystal oscillator heats VFO. Osc. section puts out sine or pulse modulated RF. With tubes, headset, cords, adapters, radiators, etc. and INSTRUCTION BOOK.
LU-3, 463-498.5 MC Cat. 2806TY1RN. \$19.95
LU-1, 470-493.5 MC Cat. 2806TY2RN. 17.95

FREQUENCY METER BARGAIN!

BC906 is also a wonderful Grid Dip Meter and Relative RF Strength Meter! Frequency 144-225 mc. covers VHF communications and 20-100 per TV channels. You tune a silver-plated cavity to resonance with a large National Velvet Vernier dial. A probe in the cavity feeds the diode plate of a 1S5 and the rectified negative voltage applied to the grid of the screen tube dials the plate current as shown on a 0-50 dc microammeter. The dial is individually calibrated with a curve showing 100 kc per dial division. The entire unit is in a compact carrying case only 1 1/2" x 8 1/4" x 6 1/2" with a leather handle. Schematic is pasted inside. Includes plug-in antenna. Specs. inside for one set. 1.5 V and 4Z batteries. This precision laboratory device is in excellent condition \$7.95

Wide-Pass Test Scope & 455 KC Panadaptor

Both in one compact unit! Brand new with schematic. Also 5.25 and 30 mc. inputs. The only modification required is to replace only one power transformer with 60 cy. units we show you how to find in your yell box and how to connect 1D-60/APA-10. A gen. that cost gov't. \$1,000!
Cat. 14061SC1RN. Only \$39.50
Excellent used depot re-packs. Hard to tell from new. Cat. 13861SC1URN. Only \$27.50

FREE! Big Bargain Catalog! Send for your copy.

All shpts. FOB whse. Send 25% dep. with all COD orders. Item sub. to prior sale & change of price without notice. Min. order \$2.50.

ARROW SALES, INC.

Western Mailing Address:
Box 3007-R NORTH HOLLYWOOD, CALIF.
Central Mailing Address & Sales-Showroom
2441 S. MICH. AV., Dept. R. CHICAGO 16, ILL.
California Distributors Stores
G. L. Electronics, Inc., 1637 Venice, Los Angeles
P.A.R.T.S., Inc., 8905 San Fernando Rd., Sun Valley

GET INTO ELECTRONICS



Valparaiso Tech trains for top flight positions. Tech. rep., field engineers, sales and specialists in communications, missiles, computers, radar, automation, color television. Basic and advanced theory and laboratory. Major companies visit school for our graduates. 21 months' course. High school grad. or equivalent. Dormitories—campus. Start April, June, Sept., Jan. G. I. approved. Write for catalog.
VALPARAISO TECHNICAL INSTITUTE
Dept. RD Valparaiso, Indiana

laboratories of the lighting division of *Sylvania Electric Products Inc.*, died suddenly . . . **MORTON LEE**, *British Industries Corp.*, passed away at the age of 46 . . . **JAMES PHILIP QUAM**, chairman of the board of the *Quam-Nichols Company*, died recently after a long illness . . . **LT. GEN. LEWIS A. PICK**, U. S. Army (Ret.), member of the executive committee of *ORRadio Industries, Inc.*, and former chief of the Army's Corps of Engineers, died recently at Walter Reed Hospital in Washington . . . **J. E. McWILLIAMS** and **HOWARD M. WINTERTSON** have been advanced to vice-presidents of *Blaw-Knox Co.* . . . **WALTER CHANNING** is now director of *Browning Laboratories, Inc.* . . . **CARL G. HOLSCHUH** has been named president and general manager of the *Sperry Gyroscope* division of *Sperry Rand Corp.* . . . **FRANKLIN P. HINMAN** has been appointed operations manager of the cathode-ray and power tube departments of *Westinghouse Electric Corporation's* electronic tube division . . . **DAVE FISHER** has been named the merchandising manager of *Sonic Industries, Inc.*

W. R. G. BAKER, vice-president of the *General Electric Company*, was recently reappointed treasurer of the Institute of Radio Engineers, Inc. Haraden Pratt was appointed to his fifteenth term as secretary. Donald G. Fink, director of research of the *Philco Corp.*, was reappointed editor of the *IRE*.

Appointed as directors were Alfred N. Goldsmith, consulting engineer; A. W. Graf, of *Graf, Nierman and Burmeister*; and William R. Hewlett, vice-pres., *Hewlett-Packard Co.* —30—

Stanford Research Institute has transformed one of the rolling hills west of Palo Alto, California into an experimental radar station with installation of a giant 61-foot diameter antenna and 100-megacycle transmitter. The equipment is being used to gather data about the reflection from meteor and auroral ionization of very-high-frequency and ultra-high-frequency communications signals.

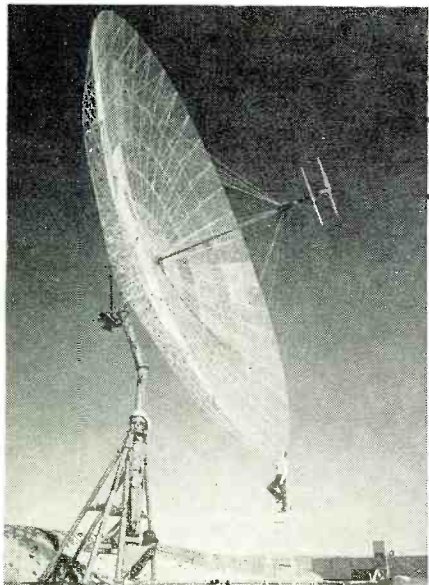

BARGAINS — OUTSTANDING SURPLUS ELECTRONICS

50 WATT, 6-CHANNEL RADIOTELEPHONE

THE RADIOTELEPHONE BARGAIN all the Pleasure and Fishing Boats are talking about! This Transmitter-Receiver (BC-669, part of CR-543) is beautifully and ruggedly built. Provides 6 fixed channels of crystal-control transmission and reception, in addition to manual tuning when desired for reception. Frequency range 100 to 4500 KC, excellent and FCC type approved for 2-3 mc marine band. With recommended 12 V. DC (or 24 V. DC) dynamotor power supply will deliver 50-60 watts output, supplied with instruction book, connecting cable, power supply constructional data, all tubes, all tested and guaranteed. See our Ad in Oct. '56 Radio Telev. News for illustration and complete data, or send for descriptive bulletin! **50 W. RADIOTELEPHONE (BC-669 A, B, or C), USED-EXCELLENT**, as described above. Shpg. wt. 185 lbs. EACH . . . \$99.50
SAME AS ABOVE, NEW-UNUSED, EACH . . . \$139.50
12 V. DC POWER SUPPLY, for above. Has 2 Dynamos, one for transmitter (540 V., at 450 mm.) and one for receiver. Produces 30/60 watts of power output. All wired and tested. EACH . . . \$89.50
COMPLETE 12 V. DC POWER SUPPLY KIT, assembly and wire yourself. All material and dynamotor included. Shpg. wt. 10 lbs. EACH . . . \$89.50
12-11 HANDSET, for above. Ant. & RF Tank . . . \$14.50

NEW, HANDY-TALKY (BC-611) CHASSIS



Here's the chance to build your own real compact, lightweight Handy-Talky or Walky-Talky. Designed to transmit and receive on one (crystal-controlled) frequency between 3.5 and 6.0 mc., any and all bands could remain the coils for operation on higher frequency amateur phone bands. This will result in increased antenna power output and longer distance transmission. By building your own case for this chassis, with space for larger batteries and increased capacity for increased power output and longer service from batteries will result. These chassis are NEW, unused, complete with telescoping antenna, but less tubes, coils, or crystals. Tubes required: 1-1R3, 1-1S5, 1-1T4, and 1-6X4. 2 miniature plug-in antenna required (sold separately). Antenna and 1-RF Tank. Battery voltages required (original 1-1.5 volt "A" and 109.5 volt "B" battery, the latter may be increased to 135 or 167.5 volts to produce higher transmitter output. Supplied with schematic diagram. Shpg. wt. 10 lbs. EACH-Chassis only . . . \$12.95
PAIR OF COILS, for above, Ant. & RF Tank . . . \$1.25

15-600 KC RECEIVER

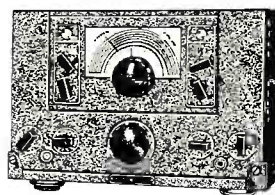

out the entire range of 15 to 600 KC in 6 bands. Employs 7 modern metal tubes in TRF circuit with regeneration, plus two audio filters to allow selection of two band widths, 600 or 1000 cps, at 20 db down with peak response occurring at 750 and 1000 cps respectively. Also incorporated audio limiter stage which reduces noise and interference. This is an excellent receiver for wireless operators, hams, and all others interested in the long and intermediate wave bands. Dim.: 17 1/2" L. x 13 1/2" H. (no shock mounts). Shipped complete with tubes, instruction sheets and diagram. Shpg. wt. 135 lbs. PRICE, EACH, NEW, Tested . . . \$79.50
PRICE, EACH, USED . . . \$39.50
PRICE, Metal Chest full of RBL spare parts such as capacitors, switches, resistors, one set of vacuum tubes, power transformer, etc. New materials. Shpg. wt. 30 lbs. PER SET . . . \$29.50

MOBILE FM RECEIVER

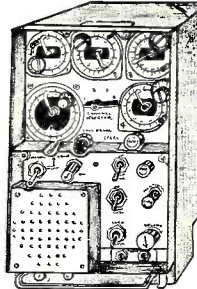

This is a "honey" in receivers, for hams, police cars, firemen, and roving photographers who want to get there first for prize photos. It's complete with built-in loudspeaker, squelch control, speaker-phone switch, sensitivity control, variable (permanently) tuning for each channel of 4 channels (permits presetting of 4 frequencies covering a range of 27.0 to 38.9 mc. By taking a half-turn off each coil winding, range can be extended to 42 or 43 mc. Operates from 12 V. DC, and includes dynamotor. Schematic diagram on bottom of each case. Dim.: 11 1/4" H. x 6 3/4" W. x 12 1/2" D. Shpg. wt. 60 lbs. NEW UNITS . . . \$39.50
USED, LIKE NEW . . . \$32.50

FM 50 W. 30-40 MC TRANS-RECEIVE STATION

FM 30-40 MC TRANSMIT-RECEIVE STATION, 50 WATTS OUTPUT. Mfd. by RBL, for Taxi, Industrial, or other application in 30-40 mc. Single channel, both transmitter and receiver are crystal-controlled, and will meet FCC specs. Receiver is double superhet. & with double limiter stages and audio squelch. All contained within metal cabinet, including 6" speaker and 110 V. AC power supply, dimensions, 40" H. x 21 1/2" L. x 11 1/2" D. Shpg. wt. 230 lbs. With Instruction Book. . . \$275.00
Like-New cond. EACH . . . \$275.00

REMOTE CONTROL FOR HAM MOBILE, MARINE OR FIXED STATION

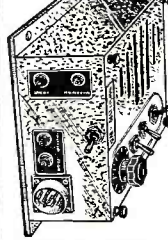

This is the popular Navy type TCS Remote Control, which includes a heavy-duty loudspeaker. Ideal for mobile (ham, taxi, truck, etc.) or Marine application either as a local or Remote Control Unit. Includes 3 toggle switches, one for tuning, "Trans." on or off; one for turning "Rec." on or off; and one for selection of "speaker" or "Phone" reception. Additional toggle switch permits "Radio" or "Intercom" usage. 2 pair of Microphone and phone jacks are provided, and connections are made through a Cannon receptacle connector (complete Schematic provided). Also provided is a T-pad volume control on front panel for regulating audio volume in speaker or phones. All units are NEW. Dim: 6 3/4" long, 5 1/4" high, and 3 1/2" deep. Shpg. wt. to base . . . \$12.95
CANNON PLUG CONNECTOR, to fit above, each \$1.25

LIMITED QUANTITY BARGAINS

GENERAL ELECTRIC 10 KW RF POWER AMPLIFIER, model BF-3A, designed to increase RF power output of FM Transmitters (88-108 mc) to 10KW. Can be modified to operate on other frequencies. Available NEW. Shpg. wt. 100 lbs. EACH . . . \$795.00
COLLINS MODEL MBF TRANSCEIVERS, covers 60 to 80 mc single channel crystal-controlled Transmitter & receiver. Full 2 watt RF output. Available NEW. Walky-Talky. Used—Good Condition. With tubes and cable less other accessories. Operates from 110V AC DC. Shpg. wt. 50 lbs. EACH . . . \$32.50
LOREN APN4 RECEIVING EQPT. Consists of R9 APN4 Receiver and ID-6/APN4 Indicator. See Oct. '56 ad in RTN for details. Excellent. Like new in original box with all tubes. May require exterior refinishing. No accessories. NOT TESTED. . . \$29.50
Shpg. wt. 80 lbs. PER SET . . . \$29.50
WILCOX 98A VHF GROUND-TOW STATION 50 Watt popular VHF Airport eqpt., complete with one receiver in excellent condition. . . \$325.00
Less tubes . . . \$325.00
LINK FM MOBILE, 30-40 MC TRANS-RECEIVING EQPT. Limited quantity of 6 volt DC Taxi or Truck FM Communications Eqpt. Transmitter is single channel (crystal controlled), 25 W. output, with self-contained dynamotor. Receiver is single channel crystal controlled, with separate vibrator pack. Each set includes Handset, Control Box with handset hanger, Loudspeaker, and connecting cables. Trans. model No. is Type 25 UFM-ED2, and Rec. is model 11 UF-ED3. Used—very good condition. Not tested. Complete with tubes. Shpg. wt., per set 100 lbs. PRICE EACH . . . \$99.50

WESTERN ELECTRIC 60 W. LOUDSPEAKER UNITS. Shock and Blast-Proof. For Horn or Baffleboard mtg. Response favors hi-freq. to 7,000 cps. Impedance 13 ohms. Dim.: 6" x 6" x 6" deep. Throat opening 1 3/4" Diam. Amico slug Approx. 6 lbs. Shpg. wt. 20 lbs. EACH . . . \$11.95
CONDENSER MICROPHONE, with 2-Stage Amplifier. Quality constructed for low-frequency. Artillery widened and extended by removing microphone from brass case. Uses 30 and 32 Tubes (not supplied in Stock). Banging or Detection application. 2-Stage Preamplifier. NEW UNITS. . . \$11.95
Shpg. wt. 25 lbs. EACH . . . \$11.95
FREQUENCY CALIBRATOR, 40-50 MC. Mfd. by Hazeltine. Permits checking accuracy of an signal by beat frequency method, between 40 and 50 mc. Uses crystal-controlled oscillator operating 8-10 mc, into Freq. Chopped, then into Buffer/Amplifier stage. Output is fed into mixer stage, along with signal being checked, demodulated and amplified and any resulting beat note determined by earphones. Includes built-in 110V. AC Power Supply, 8 tubes, and 10.0 mc crystal. Almost new condition, dim. of metal case, with hinged cover: 12" L. x 8 1/4" H. x 7 1/2" D. Shipping wt. 30 lbs. PRICE EACH . . . \$29.95
TEST EQUIPMENT IE-36, for checking SCR-522 VHF (100-156 mc) eqpts. Complete, in wooden case, includes tools, instruction book, etc. Excellent condition. Shpg. wt. 5 lbs. PRICE, EACH . . . \$49.50
TEST EQUIPMENT IE-19A, for Testing and Aligning SCR-522 eqpts. May be used with SCR-1, ARC-3, or other VHF (100-156 mc) eqpts. Includes I-95 Field Strength Meter, I-130A Signal Generator, and Battery Box BX-33. All Contained in Portable wooden chest, excellent condition. Shpg. wt. 100 lbs. PRICE, EACH . . . \$129.50
CRYSTAL-CONTROLLED, SINGLE CHANNEL, RACK MTS. RECEIVER 3-5.0 MC. Model RDE-1, mfd. by Communications Co. similar in design and physical appearance to Wilcox CW-3 and F-3 receivers. Includes 110 V. AC (built-in) power supply, and coils (plug-in) for 3 to 3.0 mc. operation. By changing coil padders (internal in coils), frequency range can be raised or lowered. NEW condition units. Shpg. wt. each 50 lbs. EACH . . . \$32.50
RCA IP25 INFRARED IMAGE CONVERTER TUBE, used in American Snooperscopes and Sniperscopes. All NEW-UNUSED Condition. Shpg. wt. 8 lbs. PRICE, EACH . . . \$49.50
BAUSCH & LOMB FRONT-END LENS, for above infrared color corrected. Speed F2.1, F.L. 3.5 inches. NEW-PREPARED EACH . . . \$19.50
BRITISH-MADE INFRARED IMAGE SNOOPERSCOPE TUBES. Used in British "Tabby" for seeing in the dark for "snooper" or sniperscopes. Will detect objects at night illuminated by "dark" infrared rays. Requires power supply of 3000 to 4000 volts at a few microamperes. Screen size is 1 3/4" dia. All tubes checked before shipment. Price includes Spas F.1, F.2, F.3 for \$10.00
FRONT-END LENS ASSEMBLY. For Spas F.1, F.2, F.3. f.1., 9.14 mm. Outside dia. at one end 60 mm. Length of mount 64 mm. Each . . . \$7.00
STEP-UP OR DOWN 120/240/460. 2KVVA. TRANSFORMER. Heavy-duty transformer, single phase. 50/60 cycles mounted in oil immersion type can approx. 22" high x 14" dia. Can be removed from can and operated air-cooled with negligible drop in efficiency due to rugged overdesign. NEW-UNUSED units, less oil. Shpg. wt. 300 lbs. EACH . . . \$44.50
All Above Material Subject to Prior Sale. 25% Minimum Deposit with All C.O.D. Orders. Order —\$5.00. All Prices F.O.B. Our Address.

— TELEMARINE —
COMMUNICATIONS CO.
 3030 W. 21st Street, Brooklyn 24, N. Y.
 Cable Address: Telemarine N. Y.
 Phone: ES 2-4300

Your choice of school
is highly important
to your career in



**INDUSTRIAL
ELECTRONICS**



**RADIO-
TELEVISION**



**ELECTRONICS
COMMUNICATIONS**

Become an
**ELECTRICAL
ENGINEER**
or an
**ENGINEERING
TECHNICIAN**
at

MSOE in Milwaukee

Choose from courses in:

ELECTRICAL ENGINEERING
Bachelor of Science degree in
36 months. Communications
or electrical Power options.

ENGINEERING TECHNICIAN
Assoc. in Applied Science de-
gree in 18 months.

Electronics Communications
Electrical Power.

MSOE — located in Milwaukee,
one of America's largest indus-
trial centers — is a national
leader in electronics instruction
— with complete facilities,
including the latest laboratory
equipment, visual aid theater,
amateur radio transmitter —
offers 93 subjects in electrical
engineering, electronics, radio,
television, electrical power,
and electricity.

Advisory committee of lead-
ing industrialists. Courses
approved for veterans. Over
50,000 former students.
Excellent placement record.

QUARTERS BEGIN OCTOBER,
JANUARY, APRIL, JULY

Choose wisely — your
future depends on it. Write
for more information today!



MILWAUKEE
SCHOOL OF ENGINEERING
Dept. RN-357, 1025 N. Milwaukee Street
Milwaukee 1, Wisconsin
Send FREE career booklet.

I am interested in.....
(Name of course)
Name.....Age.....
Address.....
City.....Zone.....State.....
If veteran, give discharge date.....

MS-57



THE TWO-DAY "Colorama" pro-
gram late in January, sponsored by
the Television Service Association of
Michigan, ushered in a year that will
bring a host of clinics and fairs spon-
sored by local, regional, and state
service associations.

The Michigan "Colorama" included
a display of the latest parts, tubes,
and equipment for the service indus-
try. The sixteen lectures that were
presented during the two-day session
included ten on color circuitry, equip-
ment, and servicing and six relating
to the business and economic aspects
of the electronic service industry. The
"Colorama" ended with a panel ses-
sion moderated by Jack Barton, first
president of the TSA of Michigan.

Several major service events are
scheduled for the month of April. The
Council of Radio & Television Service
Associations of Philadelphia is plan-
ning a three-day convention-type so-
cial and business gathering at the
Ritz Carlton Hotel in Atlantic City on
April 12, 13, and 14. Plans call for a
dinner and floor show in the hotel's
"Merry-Go-Round" bar on Friday eve-
ning, April 12. Coordinator for the
Council's three-day affair is H. Har-
rison Neel, president of the Northeast
TV Service Dealers Association of
Philadelphia.

The Midwest Electronic Service Fair
sponsored by the Indiana Electronic
Service Association will be held at the
Antlers Hotel in Indianapolis on April
19, 20, and 21. The Indianapolis Te-
levision Technicians Association is han-
dling all of the details for the exten-
sive clinic and fair that will include
displays of all of the latest service
products as well as technical lectures
and business discussions.

The spring meeting of the National
Alliance of Television and Electronics
Service Associations will be held in
New Orleans on April 28. The New
Orleans chapter of the Radio and Elec-
tronic Technician's Association is the
host organization for the NATESA
spring meeting.

The Texas Electronic Association
elected W. J. Inman of the Dallas Ra-
dio-TV Sales and Service Association,
to serve as its president for 1957. He
succeeded Van J. Roark of the Texas
Electronics Technicians Association of
Houston. The annual TEA Electronic
Fair and Clinic to be held in Fort
Worth, Texas, will have both the Dal-
las and the Fort Worth associations
serving as host organizations.

Chris Stratigos was elected presi-
dent of the Radio and Television Guild
of Long Island succeeding Murray
Barlowe, who had served in the office

for the two previous years. Ralph
Milne, editor of the *Guild News*, was
elected vice-president.

The issue of captive service as prac-
ticed by some set manufacturers and
distributors remains in the spotlight
with service associations everywhere.
The *General Electric Company*, whose
policy for controlling service on *G-E*
sets during the warranty period fanned
the flames of service resentment
against manufacturers' consumer serv-
ice practices, held a press conference
early in the year to clarify its position
with relation to the independent serv-
ice industry.

The sales of *G-E* TV sets and the
control of service policies are in the
hands of the company's Appliance and
TV Division. The company's Electron-
ics Component Division called the press
conference. For additional details on
this meeting, see the story on page 58
of this issue.

Licensing

The subject of service licensing is
pushing captive service out of the
limelight in many states where license
measures are being prepared for the
consideration of state legislatures. In
Missouri, where a license measure
sponsored by the Television Electronic
Service Association of Missouri is to
be introduced at this session of their
legislature, the newly formed Tele-
vision Electronic Association of Mis-
souri is preparing to oppose it vigor-
ously. John Glass, president of T. E.
A. M., says that his organization op-
poses service licensing because "it will
drive all small service shops out of
business and speed the trend toward
do-it-yourself servicing on the part of
TV set owners."

The Texas Electronics Association,
which plans to oppose vigorously any
service licensing measure that may be
introduced during the current session
of the Texas legislature, claims that
no license law can generate the basic
business morals that independent serv-
ice shops must have if they are to sur-
vive. Pointing out that, while license
laws are aimed primarily at the fla-
grant service gyps who catch suckers
through bait advertising and "sun-
downers," TEA members claim such
laws actually will not affect either of
these service factors.

"No license board can arbitrarily
take a business or technical license
away from a man because a number
of customers have complained about
his work," said one well informed TEA
member. "To remove a man's license,
it will be necessary to take him into
court and prove that his work was un-

satisfactory or that his charges were unreasonable. He will have to be tried under the same laws we have now. If we are unable to eliminate the crooks from our business under our present laws, we certainly won't be able to do it under a licensing system which must rely on the same laws.

"Many men who now operate full-time service businesses and a lot of our good, competent technicians started in the service business as 'part-timers.' If we make it impossible for a man to service electronic equipment as a part-time business we will eliminate the training school that provides us with some of our best men. We will have to compete with the equipment manufacturers for the services of trade-school graduates, which simply means that our supply source for experienced men will be eliminated."

TSA Views Service Future

Karl Heinzman, president of the Television Service Association of Michigan, writes: "May we at this time congratulate you and Mr. William Leonard on the feature article defining the activities of the TESA of Michigan in its effort to coordinate and organize the service industry against captive service, malpractices, shoddy competition, and unethical practices."

He goes on to outline developments that may emerge as the industry grows: 1. Manufacturers, recognizing profit potential, will enlarge the scope

of their operations to include, in addition to manufacturing, distribution, and service of all their products. 2. Large, aggressive service organizations will band together and offer the manufacturer and the consuming public package deals that will provide service for the first year after purchase as well as the years that follow. 3. Independent service technicians, dealers, distributors, and manufacturers will cooperate to keep alive a healthy industry.

This last alternative, Heinzman feels, will be most beneficial to the industry and to the consuming public. It can be achieved, not simply by fighting captive service as such, but by more positively educating independents in the technical and business sense. This is one of the goals of the TSA program.

RCA Service Stand

Policies of the *Radio Corp. of America* with regard to servicing were reaffirmed and clarified in a 5-point open letter by Frank M. Folsom on behalf of RCA. The statement, in sum:

1. Full customer satisfaction depends on a healthy independent service industry, to which RCA will continue to make information available.
 2. Independents must have equal opportunity to compete with factory service for consumer service arrangements.
 3. RCA plans to continue its serv-
- (Continued on page 162)

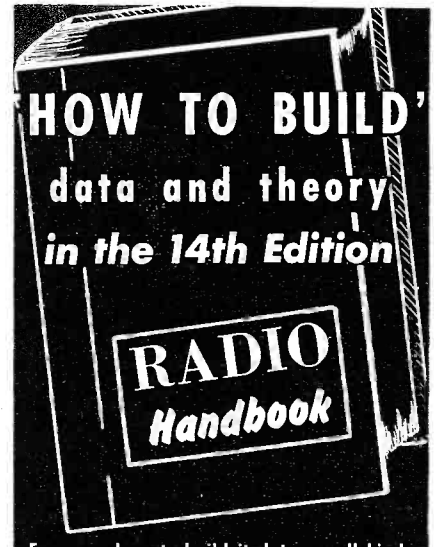

Far more how-to-build it data on all kinds of amateur and other practical radio equipment than any other publication, plus extensive simplified theory and explanations. Greatest, largest, practical radio handbook ever published. 766 pages!

\$7.50 at your dealer in U.S.A. (plus any tax)

WORLD'S RADIO TUBES (BRANS' VADE MECUM). NEW 12TH EDITION. Lists over 15,000 tubes from every tube making country. Printed in 16 languages. \$5.00



BUY FROM YOUR DISTRIBUTOR
Add 10% on direct mail orders to
EDITORS and ENGINEERS, Ltd.
Summerland 2, California

STANLEY ELECTRONICS

joins the tube crushing program

Broken Tubes — Smashed Tubes — Tubes in any condition are worth **5¢** ea.

FREE!

4-Piece Interchangeable
SCREWDRIVER SET
WITH EVERY ORDER
regardless of size!

UNCONDITIONALLY GUARANTEED FOR ONE YEAR
Prestested • Individually Boxed • Partial Listing
WRITE FOR NEW FREE CATALOG OF TUBES AND PARTS!

024	.43	6AF4	.78	6J8G	.80	7L7	.39
1A7GT	.43	6AQ5	.50	6K9GT	.47	7N7	.39
1AX2	.79	6AQ7	.69	6Q6GT	.39	7Q7	.39
1B3GT	.43	6A4	.80	6K7	.39	7Y4	.35
1B4P	.35	6AH6	.70	6K7GT	.43	7Z4	.40
1C5GT	.41	6AK5	.84	6K8Q	.68	12AT7	.41
1D5GP	.43	6AL5	.42	6K9GT	.64	12AU6	.64
1E7GT	.41	6AL7GT	.70	6L6Q	.68	12AT7	.64
1G6GT	.41	6AQ5	.44	6E4	.48	12AV6	.42
1H5GT	.43	6AQ6	.42	6E7	.48	12AU7	.64
1L4	.57	6AQ7GT	.70	6C57	.48	12AV6	.42
1L6	.47	6AM6	.80	6B7GT	.87	12AX7	.63
1L8A	.59	6AM8	.80	7A07	.41	12AX7	.63
1LCS	.49	6AS5	.48	6B7GT	.43	12AY7	.90
1LMS	.47	6AT6	.39	6K7	.43	12BA6	.46
1N5GT	.50	6AU4	.65	6B7	.50	12BA7	.60
1R4	.39	6AX5GT	.67	6B7GT	.57	12B6	.46
1RS	.51	6AV6	.39	6B7GT	.41	12BH7	.60
1S4	.59	6AV6	.39	6B7GT	.41	12BY7	.64
1S5	.51	6AX4	.67	6B7	.42	12C5	.48
1T4	.51	6AX5GT	.67	6B7	.41	12J5GT	.40
1T5GT	.51	6BA6	.47	6T7	.63	12N5	.49
1U4	.49	6A7	.57	6T7	.63	12SA7	.48
1U5	.50	6RC5	.50	6UB	.80	12SA7GT	.48
1U6	.53	6BD5GT	.53	6V6GT	.48	12S7	.47
1N2A	.46	6W2GT	.46	6X4	.39	12SK7GT	.45
2A3	.50	6EFS	.40	6W6GT	.53	12T7GT	.40
3A4	.51	6BG6G	1.18	6X4	.39	12K7GT	.45
3AL5	.57	6B6	.57	6X4	.39	12K7GT	.45
3AL6	.57	6B6	.57	6X8	.75	12L7GT	.60
3AV6	.57	6BK5	.68	6Y6	.60	12N7GT	.40
3BA6	.80	6A7A	.78	7A4XXL	.47	25Q7GT	.40
3BE6	.60	6B7GT	.75	7A5	.53	14A7	.45
3C5GT	.57	6B6	.58	7A5	.48	19B6G	1.18
3S4	.47	6B6GT	.80	7A6	.48	19T8	.70
3V4	.50	6C7A	.58	7A6	.44	25L6GT	.47
5AQ5	.80	6BY5G	.58	7E4	.44	25L6GT	.47
5AT6	.80	6B7	.88	7E5	.41	3BA5	.48
5L6	.49	6C7A	.58	7E5	.41	3B85	.48
5T4	.69	6C5GT	.35	7E7	.43	3B85	.48
5UB	.80	6CF6	.80	7E8	.47	3BL4GT	.47
5V4G	.49	6CC	.59	7C4	.39	35W4	.38
5V4G	.49	6CB	.51	7C5	.42	35Y4	.40
5X4G	.44	6CL6	1.17	7C6	.43	3E23	.41
5Y3G	.39	6CD6G	1.18	7C7	.45	3E23	.41
5Y3GT	.39	6CD6G	1.18	7E2	.25	3E23GT	.39
5Y4G	.43	6D6	.48	7E6	.30	4675GT	.40
5Z3	.54	6E3	.58	7E7	.49	60B6	.48
5Z4	.54	6E3	.58	7E7	.49	60B6	.48
6A7	.57	6M4GT	.38	7F6	.70	80C6	.48
6AB4	.80	6J5	.38	7Q7	.75	70L6GT	.45
6AB7	.80	6J5	.38	7Q7	.75	70L6GT	.45
6AC5GT	.39	6J7	.43	7J7	.75	11Z23	.37
6AC7	.67	6J7GT	.45	7K7	.75	11Z2GT	.62

Pull them out of your order. Dig them out of your garden. Crush them before shipping. You want to regard less of the shape in any tube it worth money. Any quantity — 1 to a million.

HERE'S HOW IT WORKS...
Suppose you send in 51 old, broken or smashed tubes. You will receive 5¢ credit for each tube to be applied toward the purchase of 51 new tubes of any type you want. If your order is for less than the number you have shipped to the crusher, you will receive a credit for the balance to be used against any future purchases. Pack and ship your tubes as scrap material post or freight prepaid to **Metallic Enterprises, Inc., 113 Mill St., Paterson, N. J.** with a packing slip listing the quantity of tubes shipped for credit. Send Stanley a duplicate of that slip with your order so that proper credit can be given. — **DO NOT SEND ANY TUBES TO STANLEY.**



Brand New **DUMONT AND RCA** Inc. TV PICTURE TUBES
One year Guarantee—in factory sealed carton—No dud required

10 inch	\$10.95
12 inch	\$12.95
14 inch	\$14.95
16 inch	\$16.95
17 inch	\$17.95
19 inch	\$20.95
20 inch	\$20.95
21 inch	\$22.95

Add \$4.00 to above prices for aluminized tubes

TERMS: FREE POSTAGE on all prepaid continental U.S.A. orders on receiving tubes only. 50¢ handling charge on all orders under \$5. 25% deposit on all COD's. Picture tubes F.O.B. Passaic, N. J. via Railway-Express.

STANLEY 935 MAIN AVE.
PASSAIC, N. J. Gregory 1-2498
ELECTRONICS CORP.

AIREX

THE HI-FIDELITY SUPERMARKET

WHERE THE PRICE IS ALWAYS RIGHT

RECORD CHANGER BARGAINS

NEW WEBSTER CHANGER
Heavy duty 4 pole motor. Fully automatic. Less cartridge... **\$19.95**

WEBSTER NEW 4 SPEED: changer with automatic shut-off and intermix. New 16 RPM speed. With dual sapphire styli... **\$26.95**

NATIONALLY FAMOUS CASER RELUCTANCE CARTRIDGE TYPE RPX 052A. Triple play .003 mill sapphire & .001 mill diamond. Clip-in stylus. Stylus pressure 6-8 grams... **\$17.95**

NATIONALLY FAMOUS RELUCTANCE CART TYPE 050A. Triple play sapphire needles for all records. clip-in stylus, stylus pressure 6-8 grams... **\$6.95**

DYNAKIT MARK II

The most compact high fidelity 50 watt amplifier made. 100 watt peak. Intermodulation distortion less than 1% at 50 watts, less than .25% below 35 watts. Response 6-60Kcs ± 5 db ± 1 db 20-20Kc. Input 5 volts for 50 watt output. Damping factor of 15. 8 and 16 ohm taps. Uses 2-EL34, 6AN8 and 5U4GB. Complete with all components. Prewired XXXP circuit board. Only top quality parts used throughout. **\$69.75**

With bottom cover and cage. 27 lbs...

Grommes Hi-Fi Amplifier Kits

10 Watts, 18 watts peak. Resp. 20-20,000 cps ± 1 db. Preamp., 4 input, hum-80 db, 2% Hum. Dist at 10 watts. Complete with detailed step by step instruction manual, all components, step-by-step instructions, & solder. Easy to make, 2-12AX7, 2-6V6. **\$24.95**

5Y3. Bass & Treble boost. Limited quantity.

New 20 watt Grommes amplifier kit, incl. 61PCX, 30 watts peak. Response 20-20,000 cps $\pm 1/2$ db, hum-80 db, full equalization & compensation. Complete with cage, detailed instructions, wires and solder **\$59.50**

FM-AM TUNER KIT

Easy to assemble. Professional quality performance. 3 double tuned IF stages. Foster-Seeley discriminator. Automatic frequency control & defeat. 7 tubes plus rectifier. Distortion less than 1%. Hum level -70dB. Sensitivity 6 microvolts for 20 DB quieting on FM & 20 microvolts on AM. Selectivity 200Kc band width 8 DB down; AM SKC band width 5 DB down. $5/4$ " high x $9/16$ " wide x 8" deep. Complete with step-by-step instructions. **\$29.95**

FM TUNER ONLY—\$23.95 • COVER—\$3.95
These units are ideal in combination with the Grommes Hi-Fi Amplifier. Kits listed above.

MULLARD HI-FIDELITY TUBES

Type	Replaces	Price	Type	Replaces	Price
EL37	6CA7	\$4.35	ECC82	12AU6	\$2.20
EL37	6G6, 5881;		ECC83	12AX7	\$2.50
EL84	KT66	\$3.50	EF86	2729;	\$2.75
ECC81	6XQ5	\$2.40	6267	5U4	\$2.95
	ECC81 12A17	\$2.90	G232	5V4; 5U4	\$2.95

FAMOUS UTAH SPEAKERS

12" coaxial, exclusive built-in crossover network assures a frequency response from 35 to 17,500 cps, 12 watt cap, 8 OHMS... **\$12.88**

15" woofer—response 30 to 8,000 cycles, 21.5 oz. magnet, 25 watt capacity, $1 1/2$ " voice coil, **\$19.95**

8 OHMS impedance. Reg. \$34.95

5" super tweeter—response 3000 to 19,500 cps, 25 watt capacity, $3/4$ " voice coil, 8 OHMS impedance, with built-in crossover network... **\$7.95**

JENSEN SPEAKER ENCLOSURE KITS

Now you can build any of the basic Jensen speaker enclosures at tremendous savings. All kits are cut from $3/4$ " plywood panels and all baffles are pre-cut. All hardware, glue, sound absorbing material and complete simple instructions are included. You need only a screwdriver. Brochure available.

K-101, Imperial Cabinet Kit... **\$89.00**

K-103, Tri-Plex Cabinet Kit... **\$48.00**

K-105, 15" Base Ultra-Flex Cab Kit... **\$48.00**

K-107, Concerto Cabinet Kit... **\$39.00**

K-109, 12" Base Ultra-Flex Cab Kit... **\$39.00**

K-111, 8" Base Ultra-Flex Cab Kit... **\$23.00**

K-113, Treasure Chest Cab Kit... **\$18.00**

Complete TV Set—Designed & Engineered by Tech-Master with Sylvania Aluminized Tube

Designed for fringe area operation
6 microvolt sensitivity • Automatic gain control • Auto-transformer high voltage system... **\$136.95**

tuned IF • Heavy duty power transformer • 2 stage video amplifier sweep circuit • High gain Standard Coil tuner • 17 KV high voltage output • Automatic brightness control • Complete with mounting brackets, Alnico V speaker and knobs. **\$177.95**

Standard Coil Cascade TV Tuner

Replacement for any type TV set. 41 MC. IF. Shaft length $3 1/4$ ". In lots of 3, **\$6.95 ea.**

Building Your Own Hi-Fi System? Write Us FOR PRICES ON OUR PACKAGE DEAL QUOTATION.

All merchandise is brand new, factory fresh & guaranteed. Mail & phone orders filled on receipt of certified check or MO of 20% of items as a deposit. Balance C.O.D. F.O.B. Y. Prices & specifications subject to change without notice.

AIREX RADIO CORP.

64 Cortlandt St. N.Y. 7, N.Y. CO 7-2137

ice organization's program for procuring repair and replacement parts on a basis that is fair and competitive with independent service dealers.

4. The policy of making all parts available to the service industry at large through all distributors will continue.

5. Recognition of the independent service industry in its advertising program and literature will be continued.

Mr. Folsom credited the outstanding performance of the servicing profession as sharing the responsibility for the present high level of the electronics industry as a whole. He also pointed out that less than 10 percent of service on all RCA Victor TV sets now in use is performed by the RCA Service Co., with more than 90 percent being handled by independents.

New Missouri Group

A local NATESA affiliate has been organized covering St. Francis, Jefferson, Washington, Reynolds, and Iron counties. Ed Engel, dealer at 304 Bailey Rd., Crystal City, Mo., is president.

Chicago Group for Licensing

After years of study, TESA of Chicago has thrown its support behind the principle of licensing as a means of bringing stability to the TV-radio service industry, and is bringing before the state legislature its own bill to put licensing in action.

A summary of the bill's contents, in question-and-answer form, has been circulated by TESA to interested parties, and an open meeting for discussion of the bill's provisions is being called.

TESA officers for the new year include Joseph Isaak, pres.; William Corlew, John Cahill, and Clarence Wilhelm, vice-presidents; Sydney Terman, secy.; and Bud Frohardt, treasurer. Frank Moch was re-elected as chairman of the board and Fred Levine as NATESA director.

A mutual membership plan has been set up whereby union shops become members of TESA-Chicagoland and vice versa.

Buffalo Officers

Irving Toner has been re-elected to the office of president of TESA of Greater Buffalo. Other officers include Pascal Pratt, vice-pres.; Homer G. Johnson, secy.; Ralph D'Agostino, treasurer.

Friendly Distributor

In a letter to RTA of Santa Clara Valley, Calif., distributor H. G. Smith endorses the position that the independent distributor is just as endangered by the encroachment of manufacturers in service as is the service dealer, since manufacturers attempting to dominate service will work through their own distribution channels. He urges a policy of mutual support and cooperation between independents in the service industry and in distribution.

KITS! KITS!

HERSHEL'S KITS ACCLAIMED BEST!

ALL KITS CONTAIN THE FINEST ASSORTMENTS. OVER 10,000 SOLD!

- 30 TUBE SOCKETS
- 2 1/2-lbs of HARDWARE
- 15 ROTARY SWITCHES
- 10 Electrolytic Condensers
- 40 Radio & TV KNOBS
- 40 BY-PASS Condensers
- 60 CARBON RESISTORS
- 60 MICA CONDENSERS
- 100 SET SCREWS
- B 1N22 XTAL DIODES
- 50 Ceramic Condensers
- 15 Variable Condensers (Air and Mica)
- 50 RF CHOKES
- 20 POWER RESISTORS
- 1 Phono Motor 115 Vac.
- 50 TERMINAL STRIPS
- 200 ft. HOOK-UP WIRE
- 1 TRANS. 6.3V-110 Vac.
- 5 Meissner Plug-In COILS
- 5 PILOT PANEL LITES
- 50 FUSES 3AG UP
- 1 Meter Rectifier O-1MA.
- 1 IGN. COIL 3V-15,000 VSEC.
- 25-Ft. Phono-Mike Cable
- 3 SELENIUM RECTIFIERS (65 MA. 110V.)
- 1 PHOTO Electric CELL

YOUR CHOICE ANY KIT LISTED IN THIS AD **97c**

- 10 STRAIN INSULATORS
- 1 TELEGRAPH KEY
- 5 MICRO SWITCHES
- 75-Ft. 300 OHM TV LEAD-IN
- 25 TV STAND OFFS
- 24 SHOCK MOUNTS
- 1 PHONO XTAL with NEEDLE
- 1 PIX TUBE BRIGHTENER
- 3 CONDENSERS (500 MMFD 20,000 Volt)
- 100 Ft. of SPAGHETTI
- 1 RCA Flyback Trans.
- 10 BATHTUB CONDENSERS
- 10 GRAIN WHEAT LAMPS
- 5 RADIO-PHONO CHASSIS
- 4 LOOP ANTENNAS (RADIO)
- 1 PHANTOM ANTENNA A-62
- 100 SPRINGS (RADIO-PHONO)
- 5 RADIO NOISE FILTERS
- 25-Ft. RG-58/U COAXIAL CABLE with PLUGS
- 2 Powerful ALNICO 5 Magnets

All New MYSTERY PACKAGE of ELECTRONIC PARTS

Worth \$40.00
Our Price **\$3.95**

It's the surprise of your life! 20 pounds of BRAND NEW usable C.O.V. surplus. The ideal gift for hams, etc.

Ship Wt. 20 lbs.

OIL CONDENSER \$1.65

2 MFD, Pyranol VDC-W/Mounting Oil Brackets. removed from New. $4 1/2$ " x $4 1/4$ " x $2 1/2$ " eq. equip.

ARC-5 COMMAND TRANSMITTER \$8.95

7 to 11 MC. New in cardboard. Hottest Buy in the Country.

TERMS: Cash with order or 25% DOWN—BALANCE C.O.D. ALL PRICES NET F.O.B. DETROIT MINIMUM ORDER \$2.00

HERSHEL TYler 8-9400
RADIO CO.
5249 GRAND RIVER Detroit 8, Michigan

a TERRIFIC BARGAIN in a

SOLA CONSTANT-VOLTAGE TRANSFORMER
Ends fluctuating line voltage!
Big Discount Off...



the factory price at a 1-input 2,000 VA unit! And here's another bonus! This Air Forces 2,000 VA overstock, Sola Cat. No. 30768, has 4 inputs! 90-125 V., 150-250 V., 60 cy. or 50 cy. Isolated secondary is constant 115.0 V. $\pm 1\%$ from no-load to full-load of 17.4 amp. So, if you choose, use it as a 220:115 V. step-down. And slash \$97.50 off the factory 1-input price!

Brand new in original wood box. **\$147.50**
cu. ft. Ship. wt. 254 lbs. F.O.B. Pasco, Wash. Only

THE M. R. COMPANY
P. O. Box 1220-A Beverly Hills, Calif.

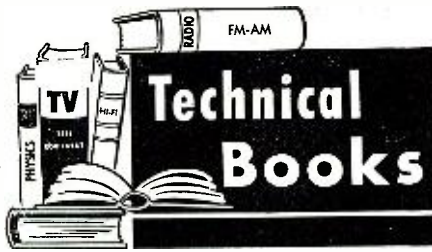

"HANDBOOK OF INDUSTRIAL ELECTRONIC CONTROL CIRCUITS" by John Markus & Vin Zeluff. Published by McGraw-Hill Book Company, Inc., New York. 344 pages. Price \$8.75.

This is a compilation of some 300 control circuits which have been published between 1948 and 1955 in *Electronics*. The circuits are grouped in chapters according to function and emphasize automatic control throughout. The text has been rigorously edited to eliminate any extraneous material. Each circuit is concisely described, with information on its general nature, performance characteristics, operation, critical components, and suggested application.

Each circuit is cross-indexed to permit locating specific circuits quickly. Engineers working in the industrial control field will find this book invaluable.

"NUMERICAL INTEGRATION OF DIFFERENTIAL EQUATIONS" by A. A. Bennett, W. E. Milne, & H. Bateman. Dover Publications, Inc., New York. 103 pages. Price \$1.35. Paper bound.

This is designed both for students and persons actually working in the field of computation. Divided into four chapters, the text covers the interpolational polynomial, successive approximations (by Bennett), step-by-step methods of integration (Milne), and methods for partial differential equations (Bateman).

Copious references and an extensive bibliography are also included for those wishing additional study material.

"RADIO-TELEVISION AND BASIC ELECTRONICS" by R. L. Oldfield. Published by American Technical Society, Chicago. 333 pages. Price \$4.95.

Since only the castaway on his desert island is unaffected by electronics, many non-technically trained persons have evinced an interest in this subject. This book should be of help to the interested and informed layman who wants to know more about the world in which he lives.

Without previous training in the sciences, the reader can learn about electricity, magnetism and electromagnetism, resistance, capacitance and capacitors, inductance and e.m.f., d.c. and a.c. currents, the instruments used for measuring, electron tubes, amplifiers, oscillators, acoustics, microphones, transmitters and receivers, speakers, hi-fi systems, television, transistors and a host of other subjects about which the educated man



Check these 'MARCH-MAD' VALUES!
HUGE \$1 DOLLAR SALE!

FREE!
ANY \$1 ITEM FREE WITH \$10 ORDER!
THIS OFFER UNLIMITED!

AMERICA'S HEADQUARTERS FOR QUALITY TRANSISTOR, SUBMINIATURE HOBBY PARTS & EQUIPMENT AUDIO • TOOLS ELECTRONICS

FREE!
8 PAGE FLYER HUNDREDS OF BARGAIN & BONUS ITEMS! Write today!

LEKTRON'S FAMOUS



DOLLARBUYS

SATISFACTION GUARANTEED!

- WIRE BY THE POUND** at scrap prices! Standard factory cut tinnecl hookup lengths. Ass'd. colors, sizes, stranding. 2 1/2 lbs. Reg. \$8. **\$1**
- SIX TIMING DEVICES.** Multi-gearred gun mechanisms, timed for 2 secs. Hand wound, accurate. Reg. \$3 each. Wt. 1/2 lb. **\$1**
- SURPRISE PACKAGE!** Every kit an experimenter's dream! 100 useful hobby radio parts. **\$1**
- 50 MICROSWITCHES.** Sensitive, bakelite encased. Metal leaf & dime-size. 100. Ass'd. contacts: 115 VAC, 10A. **\$1**
- 60 PLUGS & RECEPTACLES.** Wide variety chassis, speaker, panel, audio, power types. Wt. 2 lbs. Reg. \$8. **\$1**
- 12 POPULAR CONTROL TROLS.** volume, bias, radio & TV types. Dual & switch too. Pop. sizes, shafts. Up to 1 meg. **\$1**
- 2 CARBON MIKE XFMRs.** 200 ohm to hi-imp. grid. Encased. 2" sq. Wt. 1 lb. Reg. **\$1**
- 12 "TIP" JACKS.** ICA, Johnson, molded red & black types. Test equipment, panels, transistors, radios. Reg. \$3. **\$1**
- THREE 6VDC RELAYS** for mobile, low voltage use. Operate on 4 to 12 VDC. SPST. 10A. Wt. 1 lb. Reg. \$3 ea. **\$1**
- 15-PC. TOGGLE, JACK, BOX** sets, 9 pin handle toggle switches, 3 phone jacks, 3 alum. boxes. **\$1**
- 15W HI-FI OUTPUT XFMR.** UTC PA series. Push-pull 616's to 4, 8 & 500 ohm secondaries. Encased. Wt. 3 lbs. Reg. \$6. **\$1**
- 15 ERIE & CENTRALAB TRIMMERS.** Ceramic, ass'd. values. Singles & duals. Wt. 1/2 lb. Reg. **\$1**
- 3 OUTPUT XFMRs.** For 3-4 ohm V.C. Wt. 2 lbs. Reg. \$6. **\$1**
- 000-999 COUNTER.** Motor Root reset type; direct drive. Lowest price anywhere! Hundreds of uses. Reg. \$6. **\$1**
- 0-60 MIN. PHOTO-TIMER.** Famous Rhodes "Mark Time." Built-in 115VAC microswitch. Lens knob & escutcheon. Wt. 1 lb. Reg. \$6. **\$1**
- SCOP! TWO 7" LOOP-STICKS.** Heavy ferrite core, 5/8" dia. Extremely hi-Q. For superhets, transistors. Wt. 1/2 lb. **\$1**
- 12 ROTARY & PANEL SWITCHES.** single & double gangs, micro, power, push. A.C. Wt. 3 lbs. **\$1**
- BENCH VISE.** Heavy steel, w/clamp type base, 1 1/2" jaws. Reg. \$2. **\$1**
- 16 PRINTED CIRCUITS** on 8x16" boards. Design your own many uses! Wt. 1 lb. Reg. \$5. **\$1**
- 4 SUB-MINI RECTIFIERS** designed for printed & transistor circuits. 1/2 wave. 18x3/8" w/ leads. Reg. \$6. **\$1**
- SWITCH TRANSFORMER.** 115VAC, 60 cycle to 24V @ 3 Amps. Fly transformer for shop, surplus gear, hobbyists. Wt. 3 lbs. Reg. \$6. **\$1**
- TRANSISTOR LOOP-STICKS.** 1000 Ohm trans. input impedance. **\$1**
- TRANSISTOR COUP-LETS.** 1000 Ohm trans. 100K coupled amp. stages. 1/8" imp. 5000 DC ohms; center tapped. 7/8x7/8". **\$1**
- WORLD'S SMALLEST RADIO KIT.** 2 1/2x1 1/2x 3/4". Permeability tuner, diode, pre-drilled case. All parts, instructions. Reg. \$3.50. **\$1**
- SUN BATTERY & photo-cell.** 1 1/4" dia. Better than famed B2M! Reg. **\$1**
- 125 RESISTORS.** Carbon 1/2 to 2W, 40 values: 5% ohms to 10 meg. 50% tool! Reg. \$1 \$15
- 3 LBS. HARDWARE.** 2000 pcs. ass'd. screws, springs, washers, etc. **\$1**
- G-E PREAMP KIT** for magnetic ear phones. Chassis, parts, diagram. Less G5C7 (\$8c extra). **\$1**
- 30 SPULBULBS.** 1.1 to 6V. screw and bayonet types, miniature. **\$1**
- 100 CERAMIC CONDENSERS.** Ass'd. types, top makers. 300 values, color-coded. Discs, too. **\$1**
- 4 CRYSTAL DIODES.** Most commonly used. 1N34, 1N56, 1N58, 1N69 in poly bag. Reg. \$1 \$5
- 100 COIL FORMS.** 15 types, Assorted sizes. **\$1**
- 60 TUBULAR CONDENSERS.** 30 types. .0005 to 0.5mf to 1500V. **\$1**
- 70 TERMINAL STRIPS** and boards, 15 types, 1 to 20 screw and solder points. Wt. 1 lb. Reg. \$5 **\$1**
- 70 RESISTORS.** Insulated IRC, A-B, etc. 5 ohms to 10 meg; 1/2, 1 & 2 W. 1% & 5%. Wt. 1 1/2 lb. Reg. \$10.95 **\$1**
- 70 MICA CONDENSERS.** 30 values: .00001 to .01 mf. to 1000V. Silver, 50%. Wt. 1 lb. **\$1**
- 60 STANDARD KNOBS.** Ass'd. colors, bakelite & plastic. Wt. 2 lbs. **\$1**
- 8 TRANSISTOR SOCKETS.** For sub-miniature tubes, micro. Mica filled. **\$1**
- 4 SILICON DIODES.** Reg. 1N21, two 1N22, 1N23. **\$1**
- 40 SUBMINIATURE RESISTORS.** in poly box. 1/4" long! 20 values, 15 ohms to 10 meg. **\$1**
- 5000 OHM RELAY.** by Allied Control. 4PDT. For plate and control circuits. **\$1**
- 60 TRANSFORMERS & SOLENS.** IP, RP, antislug-tuned coils, chokes, 25 types! Wt. 3 lbs. **\$1**
- MINI-METER BUY!** 1 1/4" round, 0 to 6 amps. AC. Chromed. For model railroads, power supplies, mobile. Reg. \$3. **\$1**
- 5 ROLLS TAPE,** electrical, plastic, friction, rubber. For home, shop or lab. Reg. \$2.50. **\$1**
- 15 AC/DC LINE CORDS** for clocks, motors, etc. 2-cond. w/molded plugs. **\$1**
- 10 "POLY" BOXES.** Ass'd. sizes, clear plastic binged boxes w/ snap locks. Reg. \$2.50. **\$1**
- 40 MINIATURE CONDENSERS.** Ass'd. miniature, subminiature, printed circuit types; Centralab, **\$1**
- 30 POWER RESISTORS.** WW, carbofilm, sandcoated vitreous. 13 values, 5 to 50W; 35 to 11000 ohms. Wt. 2 lbs. Reg. **\$1**
- 20 PRECISION RESISTORS.** WW & carbofilm. 30 values, 56 ohms to 1 meg; 1/4, 1 & 2W. 1% tol. Wt. 1/2 lb. Reg. \$21. **\$1**
- 25 TUBE SOCKETS,** 4 to 11-prong miniatures, subminiatures, octals, zipins. Tube shields, too. **\$1**
- 10 ELECTROLYTICS.** For FP, 2500 to 5000 mfd. at 450V. Wt. 3 lbs. **\$1**
- 8-PC. NUTDRIVER SET.** Plastic handle, 3/16, 7/32, 1/4, 5/16, 11/32, 3/8, 7/16" steel socket wrenches in plastic case. **\$1**
- 15-PC. TWIST DRILL SET.** 1/16 thru 1/4" by 64ths; in graduated plastic holders. Reg. \$4. **\$1**



LOOK! Personal/Pocket SUPERHET RADIO
WIRED—READY TO PLAY! BIG SET PERFORMANCE. NO EXTERNAL CONNECTIONS. FULLY GUARANTEED!
ONLY 12.99

This amazing pocket radio sold elsewhere for \$20-\$27! Molded ivory case, 5 1/2x3 1/2x1 1/4" slips easily into pocket. Built-in super-sensitive ferrite antenna. Big set performance in volume, sensitivity, selectivity, marked. Broadcast band, 530-1650 kcs. Conrad frequencies plainly Guaranteed satisfaction! Wt. 1 lb.



SOLAR-CELL TRANSISTOR RADIOKIT

A KIT KING EXCLUSIVE!
 Dual-powered, pocket size! Sensitive, selective, w/ample volume. Sun battery for daytime or electric light. Mercury cell for night—outlasts regular batteries times MINUTES!
 COMPLETE—ALL PARTS MOUNTED! Pre-drilled styrene cabinet, step-by-step instructions, hi-train transistor, diode, latest loopstick permeability posts, 60 posts, jacks, wire, hardware. Wt. 3 oz. **\$5.88**

HOW TO ORDER

BATTERIES \$2 EXTRA
 CARRYING CASE
 W/SHOULDER STRAPS...\$1.99
Check items wanted. Return entire ad w/check or M.O., including sufficient postage; excess returned. C.O.D. orders 25% down. Rated, net 30 days. Print name, address and amount money enclosed in margin. RTM-3

LEKTRON SPECIALTIES
131-133 Everet Ave. Chelsea 50, Mass.

Top Pay Jobs in TV-ELECTRONICS-RADIO

High pay, opportunity, prestige, security... all yours, as a qualified Electronics Technician! Get your training NOW in the big, recognized shops, Labs, and TV-Radio Studios at National Schools in Los Angeles, foremost since 1905. Here you work with latest Electronics equipment—professionally installed—finest, most complete facilities offered by any school. Expert, friendly instructors. Personal attention. Graduate Employment Service. Help in finding home near school. Part time job while you learn. Mail coupon NOW, TODAY... for full information.

NATIONAL SCHOOLS

National Schools Dept. RXH-37
4000 So. Figueroa Los Angeles 37, Calif.
Send Free Electronics Opportunity Book Today

Name _____ Age _____
Address _____
City _____ State _____

ONE DOLLAR BUYS

- 1 - 5" PM SPEAKER alnico #5 magnet.....\$1
- 100 - ASSORTED 1/2 WATT RESISTORS.....\$1
- 10 - 6 FT. ELEC. LINE CORDS with plug.....\$1
- 5 - TV CHEATER CORDS with both plugs.....\$1
- 100' - TWIN LEAD-IN WIRE 300Q heavy duty...\$1
- 3 - AUDIO OUTPUT TRANS. 6K6 or 6V6 type...\$1
- 50 - ASS'T. TUBULAR CONDENSERS 85°.....\$1
- 1 - \$8 INDOOR TV ANTENNA hi-gain 3 section..\$1
- 1 - \$4 CRT BOOSTER new life to old tubes.....\$1

More Sensational Values
1000 Hundreds more "Dollar Buys"
Write for New Catalogue—FREE

CAPITAL ELECTRONICS
218 FULTON ST., N. Y. 7, N. Y. CO-7-7842

Buy The World's First Color Television Annual!

136 pages covering every phase of Color TV

- FUNDAMENTALS OF COLOR TV (A Complete Course)
- COLOR SETS ON THE MARKET
- PICTURE TUBES AND COMPONENTS
- TECHNICAL ANALYSIS OF SETS
- SERVICING AND INSTALLING
- TEST INSTRUMENTS FOR COLOR TV
- CONVERTERS, COLOR WHEELS, VITASCAN

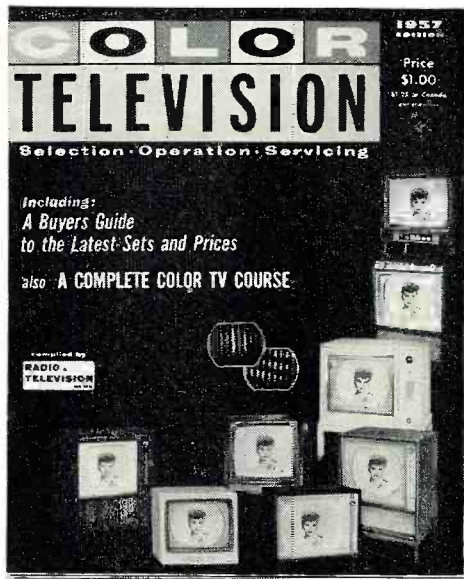

NOW ON SALE AT ALL NEWSSTANDS—ONLY \$1.00

HERE'S HOW TO GET YOUR START IN RADIO ELECTRONICS

No matter what part of radio-TV-electronics you plan to enter, this is the **BASIC** training you need!

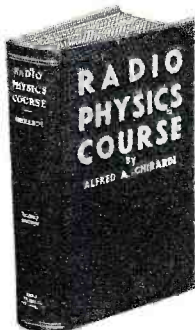

Here's basic training you can really understand... training that can help fit you for a good pay radio-television-electronic career!

Ghirardi's **RADIO PHYSICS COURSE** is the oldest book of its kind... and still a best seller because it is so amazingly clear and complete. More experts now in electronics got their basic training from this giant book than any other of its type—and they'll recommend it to you today! Starts with Basic Electricity (over 300 pages) then takes you step by step through the entire radio-electronics field. Covers principles, theories and practices that are basic to even the most modern equipment. 972 pages; 508 pictures. \$56 helpful self-review test questions. Price only \$6.50.

RADIO PHYSICS COURSE by A. A. Ghirardi
Complete basic training for beginners

—STUDY 10 DAYS FREE!

Dept. RN-37, RINEHART & CO., INC.,
232 Madison Ave., New York 16, N. Y.

Send Ghirardi's **RADIO PHYSICS COURSE** home-training book for 10 days free examination. I will then either return book promptly or send you \$6.50 plus postage in full payment. (SAVE!) Send \$6.50 with order and we pay postage. Same 10-day return privilege with money refunded.)

Name

Address

City, Zone, State

OUTSIDE U.S.A.—\$7.00 cash only. Money back if book is returned in 10 days.

RAD-TEL MARCH SPECIALS!

#75 MICA CONDENSERS

Kit of 50—all popular sizes in regular and silver construction. FM and TV use.

Lots of 3 kits

1.85 ea.

Single, \$1.95 ea.

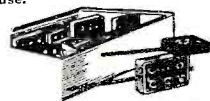

#285 PRINTED CIRCUIT SOCKET KIT

9 Pin & 7 Pin
Reg. Net 13c to 20c each. 5 models in each! **40c**
KIT OF TEN

BUY ONE OF ABOVE KITS AND GET ONE KIT FREE. Same kit only. Ad must accompany order. Applies only to kits #75 and #285.

#219 VIBRATOR POWER TRANSFORMER

250 VAC, 40 ma. vertical mounting. List, \$2.25.
49c ea.
Lots of 3

29c ea.

AUDIO OUTPUT TRANSFORMER

#90 6V6

#89 50L6

#2B72 1T5

49c ea.



WIRE KIT

3' to 15' stranded, solid hook-up wire, plastic, etc. Striped ends. All usable sizes.

1 lb. 50c

2 lbs. 75c

5 lbs. \$1.50

VERTICAL OUTPUT TRANSFORMER

Prim. res. 318 or Sec. 8-47r. Turn ratio is 58.7. WELL KNOWN MAKE

99c

Single, \$1.25

#292 FILTER CHOKE 1.3 H., 260 ma., 60 ohms. Lots of 3

29c ea.

Single, 49c ea.

#284 TUBE SOCKETS KIT

Kit of 20 popular types!

\$1.00

Write Dept. RN-3 for FREE Catalog of Tubes & Parts!
No C.O.D.'s please. Allow for postage. Subject to prior sale. No handling charge with this ad!

115 COIT ST., IRVINGTON 11, N. J.

is expected to be conversant. An excellent "first book" for the layman.

* * *

"**RADIO TELEMTRY**" by Myron H. Nichols & Lawrence L. Rauch. Published by *John Wiley & Sons, Inc.*, New York. 455 pages. Price \$12.00. Second Edition.

Both lay and technical interest in the field of telemetering has been stimulated by the widespread publicity being given to our guided missile and satellite programs. While this volume is written for the engineer and those directly involved in such development projects, the fact that such a book has been published is indicative of the vital part such techniques is coming to play in our lives.

After an introductory and historical chapter the text deals with methods, foundations, and techniques involved in telemetering. Fourteen complete and elaborate appendices plus a bibliography and glossary complete the text. Treatment is mathematical and students are advised to have a good working knowledge of calculus, trig, and algebra to tackle this text.

* * *

"**CALCULUS REFRESHER FOR TECHNICAL MEN**" by A. A. Klaf. Published by *Dover Publications, Inc.*, New York. 421 pages. Price \$1.95. Paper bound.

This publisher is performing a real service by issuing a series of technical volumes in a simple and inexpensive format which puts these books within the reach of anybody's pocketbook.

In the interest of "upgrading" technical men who may have "forgotten more math than they ever knew," this is a compact, no-nonsense review of the basics of integral and differential calculus. Specific applications in the engineering field are included and there are 542 problems and answers with which the student can test his grasp of the subject. Some 36 pages of useful formulas and tables have been included so this book can be used for reference as well as review.

* * *

"**TRIGONOMETRY REFRESHER FOR TECHNICAL MEN**" by A. A. Klaf. Published by *Dover Publications, Inc.*, New York. 606 pages. Price \$1.95. Paper bound.

This is another of this publisher's "Refresher" volumes which are designed to improve the techniques by which engineers handle their jobs. Some 24 pages of formulas and tables combined with 1738 problems and answers for the student's use make this book valuable as a reference work as well as providing the necessary "sharpening" to bring long-forgotten high school and college trig courses into focus for daily application.

* * *

"**IMPROVE YOUR TV RECEPTION**" by John Cura & Leonard Stanley. Published by *Iliffe & Sons, Ltd.*, London S.E. 1. 103 pages. Price 5 s. plus 4 d. postage. Paper bound.

This is a complete and clear "operating manual" for the owner of a tele-

vision receiver. The authors have pointed out that the correct adjustment of the various front panel controls can make a world of difference in the quality of the received picture and proceed to explain what each control does and how it is to be adjusted for best reception.

A section entitled "Facts and Fallacies" answers some 136 questions most often asked by set owners regarding their equipment. This book neither covers nor encourages "do-it-yourself" servicing, being confined solely to those controls within the province of the user. The equipment covered is of British manufacture.

"DAVE RICE'S OFFICIAL PRICING DIGEST" compiled and published by *Electronic Publishing Co., Inc.*, 180 N. Wacker Drive, Chicago 6. 246 pages. Price \$2.50.

A new edition of this quarterly publication for the service technician is now available and lists approximately 66,000 radio and television parts along with their list or resale prices.

These "Digests" provide technicians with a single up-to-date source for the prices of all items they use or sell in their work.

"HI-FI FROM MICROPHONE TO EAR" by G. Slot. Published by *Philips Technical Library*, Eindhoven, Holland. 165 pages. Price \$2.75 postage prepaid direct from publisher.

This volume is one of the "Popular

Series" in the *Philips* catalogue, hence the treatment is, for the most part, non-technical. There are chapters devoted to the development of modern records, pickups and what they do, the needle and its role in hi-fi reproduction, needle and record care, record players and changers, amplifiers, speaker operation and characteristics, acoustic problems and their solutions, hi-fi testing, and tape recording.

The text is well illustrated, mostly by photos of European-built equipment, but since the world of music knows no barriers, this book will be of interest to all audiophiles.

"TV TUBE LOCATION AND TROUBLE GUIDE" by Rider Staff. Published by *John F. Rider Publisher, Inc.*, New York. 46 pages. Price \$1.25. Paper bound.

This volume in the publisher's "Tube Location" series covers sets made by *RCA* from 1947 through 1956. As was the case with earlier volumes in this series, a comprehensive index is included in the front of the book listing sets by model and chassis number. The user is then referred to the appropriate page where the top chassis view of each receiver is given along with a listing of the tubes used in the circuit and a trouble chart.

Technicians who do considerable work on receivers made by *RCA* would do well to have a copy of this book to cut down unnecessary and time-consuming troubleshooting.

ALL NEW
BIGGER THAN EVER!



FREE
NEWARK'S
Complete
ELECTRONICS
Catalog No. 65
Here's everything in Industrial
Electronics, High Fidelity,
Radio, TV and Amateur
Equipment

Write
today

NEWARK
ELECTRIC COMPANY

Mail Order Division . . . Dept. R-3
223 W. Madison St., Chicago 6, Illinois
4736 W. Century Blvd., Inglewood, Calif.

Apology to Readers of Radio & Television News
Due to the tremendous response to our wonderful values in tubes, our huge staff at Video Electric Co. was unable to adhere to our Same Day Shipment policy. For this reason, some orders were delayed a number of days. We at Video wish to offer our profound apologies for any inconvenience caused our customers. We are attempting to remedy the situation at once.

PROMPT SHIPMENT ON ALL ORDERS

\$3700 DON'T PAY MORE FOR SET
Per Hundred TESTED LONG LIFE DEPEND-
ABLE RADIO & TV TUBES •
BUY VIDEO INDIVIDUALLY
BOXED • ALL GUARANTEED
FOR ONE YEAR OR YOUR MONEY BACK

Some Standard Brand—Others With Famous VIDEO Brand

0A2	5U4G	6H6GT	12AT7
0A3	5U8	6J4	12AU6
0A4	5V4G	6J5GT	12AU7
0B2	5V6GT	6J6	12AV6
0C3	5Y3	6K6GT	12AX7
0Z4	5Y4G	6L6	12AX4GT
1A7GT	6A4	6N7GT	12AX7
1B3GT	6AC7	6S4	12A27
1C7G	6AG5	6S7G	12B4
1F4	6AF4	6SA7	12AC6
1H4	6AH4GT	6SB7Y	12BE6
1H5GT	6AK5	6SC7	12BH7
1I6GT	6AL5	6SD7	12BT7
1L4	6AM8	6SF7	12C06
1L6	6AN4	6SG7	12SA7
1LA6	6NB	6SH7	12SC7
1L6S	6Q5	6SJ7GT	12SH7
1LH4	6AQ7GT	6SK7GT	12SJ7GT
1LN5	6AS5	6SL7GT	12SK7
1NSGT	6AS7G	6SN7GT	12SN7GT
1S4	6AT6	6SQ7	12SQ7
1S5	6AU4GT	6SS7	12V6GT
1T4	6AU5GT	6S7	12X4
1U4	6AU6	6T8	14A7
1U5	6BU5GT	6U4GT	14B6
1V2	6AV6	6U7G	14Q7
1X2	6AX4GT	6U8	19BG6G
2A7	6AK5GT	6V3	19T8
2D21	6B6	6V6GT	25A6
2X2	6BC5	6W4GT	25AV5GT
3A4	6BC7	6W6GT	25R06GT
3A5	6BE6	6X4	25C06G
3AL5	6BF5	6X5GT	25C06
3AUG	6BG6G	6X8	25L6GT
3BC5	6BH6	6Y6G	25W4GT
3C6	6BJ6	7A5	25Z6GT
3Q4	6BK5	7A7	35L6GT
3Q5GT	6BK7	7B5	35W4
3S4	6BL7GT	7B7	35Y4
3V4	6BN6	7C5	36
4B27	6BQ6GT	7C6	35Z3
4B7	6BQ7	7C7	35X5GT
5A8S	6BY5G	7F7	50A5
5A8S	6BZ7	7F8	50B5
5A8S	6C4	7N7	50C5
5AT8	6CB6	7Q7	50L6GT
5AW4	6CD6G	7Z4	80
5A74	6C76	7Z4	80
5J6	6CS6	12A6	117N7GT
5T4	6CU6GT	12AH7GT	117P7GT
5T8	6E5	12AT6	117Z3

40¢

FOR ANY
TUBE

we will not be
undersold

VIDEO

ELECTRIC COMPANY
79 CLINTON PL. NEWARK, N. J.
Phone HUmboldt 4-9848

We Have OVER 1000
USED TV SETS

At All Times In Our Huge Warehouse

Buy one or more of these WORKING
TVs to sell or use as your own second
set! All Sets in GOOD WORKING con-
dition!

Your Choice—Console or
Table Model

10" . . . \$23.00	19" . . . \$58.00
12" . . . \$28.00	20" . . . \$64.00
14" . . . \$33.00	21" . . . \$72.00
16" . . . \$40.00	24" . . . \$99.00
17" . . . \$46.00	

When ordering TV's, state whether
table model or console is desired.
Also preference on make of set. All
TV's sent railway express P.O.B.
Newark. On any quantity WIRE or
CALL today!

FREE BONUS ANTENNA
GIVEN WITH ANY TV SET
ORDER!!

FREE RCA "CHEATER" CORD
GIVEN WITH ANY TUBE OR-
DER OF \$7.00 OR MORE!!

FREE POSTAGE in U.S.A. and
Territories on orders over \$5.00.
25¢ handling charge on orders
under \$5.00. 25% deposit re-
quired on C.O.D.'s. Please send
approximate postage or freight
on Canadian and foreign or-
ders. Subject to prior sale.

SEND for our FREE com-
plete TUBE & PARTS LIST
and order blank.

QUARTZ CRYSTALS

Fast Service—Unconditional Guarantee!

Crystals ground and etched to your specified frequency at the lowest cost in the industry—supplied in popular FT-243 holders, 1/2" pin spacing, .093" pin diameter—also in DC-34 holders, 3/4" pin spacing, pin diameter .156 or FT-171 holders, pin spacing 3/4" with banana plug pins (fits 5-prong tube socket).



In FT-243 holders from 1005KC to 9000KC. In DC-34 or FT-171 holders from 1100KC to 8000KC (specify holder wanted).

Tolerance:

.05%\$1.35
.01% 1.50
.005% 2.50

With thousands of frequencies in stock for immediate delivery, we list a few of the more popular frequencies. Write for complete listing. Crystals listed ore in FT-243 holders but can be supplied in FT-171 holders at 79 cents. (Add 5¢ per crystal for postage and handling.)

2910	6150	7206	8106
2945	6300	7225	8125
3000	6400	7240	8140
3190	6500	7250	8150
3195	6575	7273	8175
3245	6625	7275	8200
3525	6700	7300	8240
3885	6706	7306	8250
3955	6750	7325	8300
3995	6775	7340	8350
4110	6800	7350	8375
4190	6850	7373	8400
4845	6900	7375	8425
5030	6950	7400	8450
5300	7000	7406	8475
5305	7006	7500	8500
5700	7025	7606	8525
5800	7050	8000	8550
6000	7075	8006	8575
6025	7100	8025	8600
6040	7106	8040	8625
6050	7125	8050	8650
6075	7140	8073	
6100	7150	8075	
6125	7200	8100	

YOUR CHOICE
50¢
EA.
OR
11 FOR \$5.00
POST-PAID

WRITE FOR FREE CRYSTAL CATALOG

Novice Crystals 80 meter band within 1KC of specified frequency from 3701KC to 3749KC in 40 meter band from 7152KC to 7198KC within 1KC of specified frequencies 79¢; in DC-34, FT-171 or FT-243 holders (specify holder wanted) 79¢. (Add 5¢ per crystal for postage and handling.)

Stock crystals in FT-243 holders from 5675KC to 8650KC in 25KC steps 50¢.

FT-241 lattice crystals in all frequencies from 370KC to 540KC 50¢.

100KC Frequency Standard Crystals	4.50
200KC Crystals	2.00
455KC Crystals	1.00
500KC Crystals	1.00
1000KC Frequency Standard Crystals	3.50
Dual socket for FT-243 crystals	.15

Low frequency FT-241 crystals from 880.20KC to 1040.62KC in steps of 1040 cycles 75¢

(Write for complete listing.)

Texas Crystals

The Biggest Buy in the U.S.

8538 W. GRAND AVENUE · RIVER GROVE, ILL.
ALL PHONES — GLADSTONE 3-3555

Terms: All items subject to prior sale and change of price without notice. All crystal orders MUST be accompanied by check, cash or M.O. WITH PAYMENT IN FULL. NO C.O.D.s. Postpaid shipments made in U.S. and possessions only. Add 5¢ per crystal for postage and handling charge.



EQUIPMENT CATALOGUE

Precision Equipment Co., 3706A Milwaukee Ave., Chicago 41, Ill., has issued a new 24-page catalogue listing a wide variety of office equipment, industrial ovens, flow lockers, safety ladders, as well as a completely transistorized portable p.a. system for sales meetings, conventions, etc.

Much of the equipment illustrated and described in this catalogue is suitable for service shop applications. Interested persons are invited to write for a free copy.

SOLDERLESS WIRING

Electric Terminals Corp., 2021 Center St., Cleveland 13, Ohio has issued a new 8-page technical bulletin which illustrates, describes, and furnishes sizes and specification data on its new time-saving solderless terminals and connectors for crimping to wire extremities.

Copies of "Solderless Wiring Devices" are available without charge.

SWITCHES AND RELAYS

A complete catalogue of its switches and relays has been issued by Jaidinger Mfg. Co. Inc. of 1921 W. Hubbard St., Chicago 22, Ill.

The publication shows approximately forty different "Jaico" switches and relays, ranging from standard size units to the miniature and describes the operation and characteristics of each. The catalogue also shows many of the new developments in these components and gives complete specifications, size, capacities, and other information of importance to engineers, designers, and manufacturers.

HEXACON SOLDERING TIPS

Hexacon Electric Co., 119 W. Clay Ave., Roselle Park, N. J., is offering free copies of its new catalogue No. 144, which lists and illustrates its entire line of long-life soldering tips.

With 40 stock sizes and shapes and many special styles to choose from, the company now offers a complete line of long-life types. The various shapes of plug and screw tips are illustrated along with data on tip diameter and length, style of tip point, and size of tip point. The soldering irons in which the tips will fit are indicated.

ELECTRONIC PRODUCTS

Superior Tube Company is providing up-to-date information on its line of cathodes and other tubular electronic parts in a revised catalogue which has just been released.

Designated as Catalogue No. 51, the 20-page publication describes two new additions to the firm's line: a narrow

BE QUALITY WISE... BUY QUAL-KITS!



HI-FI AMP. KIT
Complete 6 tube-10 watt amplifier. Push-pull beam power output, built-in pre-amp. 5 position selector switch, 3 position record equalization, LP, RIAA, Eur. Response 1/2 db. 20-20,000 cps. Output 10 watts at less than 2% IM. Low noise level and harmonic distortion. **\$28.50**

Every kit complete with 28 page fully illustrated instruction and assembly manual. Cover and legs optional.



HI-FI AM-FM TUNER KIT
Advanced 7 tube circuit plus Rectifier for full sensitivity and selectivity. Distortion less than 1% Sensitivity is 5 uv for 30 db quieting on FM, 25 uv AM. Armstrong FM Circuit with limiter, Foster-Seeley Discriminator. 20-20,000 cps response. Full AFC control — no drift. Easy assembly. **\$28.95**

Add 10% Fed. Tax Write for FREE catalog and name of nearest dealer carrying these remarkable units.

QUALITY-ELECTRONICS

319 Church St. Dept. T-3 New York 13, N. Y.

Watch for Our New Title

RADIO & TV NEWS

Next Month

NOW!

Step ahead faster

as an INDUSTRIAL ELECTRONICS TECHNICIAN



Turn your experience into a big, new better-paying career!

Day by day industrial plants are adding more electronic devices—for sorting, counting, checking almost any control job you can name. Cash in on industry's great need for men who can keep these devices in top working order. Make more money, feel more secure, doing work that is second nature to you. With what you already know about electronics you have a long head start in a field just beginning to boom. GET INTO IT RIGHT NOW with the help of

PRACTICAL INDUSTRIAL ELECTRONICS LIBRARY

No long sessions on math or theory! These 4 practical volumes show you how to keep the plant's electronic equipment working... how to locate and correct tube and circuit troubles... how to install, service, and maintain even brand new equipment without being stumped by new circuits.

FREE TRIAL—EASY TERMS

4 volumes (1969 Ed.) 1102 illus. Chute's Electronics in Industry
Miller's Maintenance Manual of Electronic Control
Markus & Zeluff's Handbook of Industrial Electronics Circuits
Henny & Fahnestock's Electron Tubes in Industry

McGraw-Hill Book Co., Dept. RTN-3, 327 W. 41 St., N. Y. C. 36

Send me the Practical Industrial Electronics Library for 10 days' examination on approval. In 10 days I will send \$2.50, then \$4.00 a month until \$22.50 is paid. (A saving of \$4.50 under the regular price of \$27.00.) Otherwise I will return books postpaid. (Print)

Name

Address

City Zone State

Company

Position

For price and terms outside U. S. write McGraw-Hill Int'l., N. Y. C.

neck disc cathode and "Cathaly P-51."

Copies of this new catalogue are available without charge by writing the company at 1851 Germantown Ave. in Norristown, Pa.

NEW SEMICONDUCTORS

Raytheon Manufacturing Company, 55 Chapel St., Newton 58, Mass., is offering a new and enlarged version of its semiconductor products booklet which is currently available from the firm's industrial tube distributors.

The 8-page publication contains complete and up-to-date information on the company's transistor and diode line. Pertinent characteristics and specifications on over 80 of these units are included. Over one full page of representative physical specifications are included for the firm's typical product line. The transistor section lists 34 different types.

If a distributor is not located near you, copies may be obtained from the Receiving and Cathode Ray Tube Operations division of the company.

SIMPSON PANEL METERS

Simpson Electric Company, 5200 W. Kinzie St., Chicago 44, Ill., is now offering copies of its new 6-page panel meter bulletin, No. 2057.

The publication contains descriptions and specifications along with latest prices on the over eight hundred models which go to make up the company's stock line. The brochure includes photographs of meter styles and various types of meter movements available, along with dimensional drawings for meter mounting.

Local distributors have this bulletin available or it may be obtained direct from the manufacturer.

SILICONE REFERENCE GUIDE

Dow Corning Corporation of Midland, Mich., has released copies of its new "1957 Reference Guide" to silicones. Almost 150 commercially available silicone products are described, including several which were developed within the last year.

The products are grouped by usage (water-repellents, dielectrics, release agents, etc.), enabling engineers to locate a material by what it does as well as by what it is. Descriptions are brief and factual with emphasis on charts, tables, and graphs. The guide, which runs to 12 pages, is printed in two colors. It is available without charge on request.

RCA LAB INSTRUMENTS

The Commercial Electronic Products Division of Radio Corporation of America, Camden, N. J., has issued a 6-page brochure covering its new line of thirteen instruments which have been designed especially for advanced electronics.

Included in the new line are measuring and generating equipment. The former includes precision d.c. voltmeters, wide-band a.c. voltmeters, audio-frequency impedance bridges, and r.f. power meters. The generating equip-

SCR-522 VHF Transceiver—100-156 Mc. 4 channels, crystal controlled, complete with tubes
New \$39.50 Used \$29.50

AN/APR5A—Airborne superhet radar search rec. Freq. range 1000 to 6100 MC. Rec has a 10 MC IF band width operating from 80/115V AC, single phase 60 to 2600 cps, and one amp. at 26V DC—complete with tubes. \$149.50

COMMAND ARC-5 TRANSMITTER
T-20...4 to 5.3 MC New
T-21...5.3 to 7 MC \$5⁹⁵
Used T-23 100-156 MC \$3.95
New T-23 100-156 MC \$13.95
Used T-23 100-156 MC \$9.95
3 to 4 mc. like new \$5.95
Excellent
RECEIVERS Used
190-550 KC \$9.95
1.5-3.0 MC 7.95

RCA MOBILE RECEIVER
30-41 mc. AM Crystal Controlled. \$14.95 each.
DYNAMOTOR FOR ABOVE
6V DC Input-250 V DC Output. \$6.95 each.
RCA MOBILE TRANSMITTER
30-41 mc. AM Crystal Controlled. \$14.95 each.
DYNAMOTOR FOR ABOVE
6V DC Input-375 Volts 250 ma Output. \$9.95 each.
ALL 4 ABOVE USED UNITS \$39.50

FM WOBULATOR CAPACITOR
Frequency modulation unit with a permanent magnetic field and a moving coil mechanism driving a metal diaphragm supported at the rim. This diaphragm sets in a moving plate of the frequency modulator capacitor. W/instructions. Build TV sweep sig. gen. BRAND NEW \$2.75
2 for only \$4.95

Sweet Oscilloscope Deals
INDICATOR UNIT. For conversion to test scope, panadapter, analyzer, etc. Double deck chassis. 5CPI mounted in tube shield. Less small tubes and crystal, but complete with 5CPI. \$9.95
Exc. Cond. each

ASB-7 Radar Indicator Unit: For conversion to test scope or for use as modulation monitor. Has standard test-scope CR tube, H Cent, V Cent, Brill, Foc, Gain, and range selection switch. External power source was used. Tubes: \$9.95
4-6AC7, 3-6H6, Less 1-5BPI. New

BC929 RADAR, \$9.95
BC-929 A Radar Indicator Scoop. This unit could be rebuilt into a fine test scope. It is an ideal size. 8x9x14 priced with tubes 2-6SN7, 2-6H6, 6G5, 6X5 and 2X2. This is a red hot buy. Scoop Price New w/schematic & Conversion Data \$9.95

LORAN APN-4
FINE QUALITY NAVIGATIONAL EQUIPMENT

Determine exact geographic position of your boat or plane! Complete, BRAND NEW installation consists of: 1D-6B/APN-4 Indicator; R-9B/APN-4 Receiver; PE-206 Inverter; Set of Plugs; Visor for Indicator; Operation manual; \$129.50
Brand New. Export packed.
ID6B INDICATOR, R9B RECEIVER, \$69.50
Excellent

UHF TRANSCEIVER, APG-5
2500 Mc complete with 2C43, 2C40, 3E29, 1B27, VR105, 5Y3, 6AL5, 2 each \$39.50
2X2 and 8 each 6AK5

PE109 INVERTER
12VDC input, 115 VAC, 1 1/2 amp, single phase, 400 cycle output.
Brand New \$34.50
Exc. Used \$27.50

WRITE FOR NEW BULLETIN

ALL ITEMS F.O.B. CHICAGO 25% Deposit required with orders

R W ELECTRONICS Dept. N 2430 S. Michigan Ave. Chicago 16, Ill.
PHONE: CAumet 5-1281-2-3

\$45.00 Hi-Fi Headset

Uses annular grooved plastic fibre cones with voice coils as in speakers, and chamois ear pads to obtain spacing for correct acoustical load. GIVES FINEST MUSIC REPRODUCTIONS! Imp.: 300 Ohms per unit or 600 Ohms when wire series.

USED. EXC. COND. \$4.95
WITH BRAND NEW CHAMOIS CUSHIONS \$6.19

APG 5 or 15 CAVITY

10 Cm. 2C43 osc Xmitter, 2C40 Loc. Osc. Rec. 1B27 TR; tunes 2400 to 3000 MCS, less tubes. Price \$4.95

Radio Receiver 11-tube UHF tunable 234-258 MC receiver with schematic. Complete with tubes, 3 ea. of 6AK5, 7 ea. of 9001, 1 ea. of 12A6, Like new Less Tubes \$6.95
..... \$2.95

SCOPE TUBES

2AP1
3BP1
3CP1
3EP1
3HP1
5AP1
5CP1
\$1.95
ea. 4 for \$7.00

DYNAMOTORS

Type	Input	Output	Excellent New
BD-77	12 VDC	1000 VDC	350 MA \$14.95
BD-83	12 VDC	375-150 MA	1.95
DM-37	24 VDC	625 VDC	225 MA 2.95
DM-34	12 VDC	220 V	80 MA 2.95 4.95
DM-65	12 VDC	440 VDC	400 MA. 14.95 19.95
DA-1A	24 VDC	230 VDC	100 MA. 4.95
DM-28	24 VDC	230 VDC	100 MA. 4.95
DM-32A2	12 VDC	250 VDC	60 MA 4.95

MOBILE HEAVY DUTY DYNAMOTOR: 14 V. INPUT-output: 1030 VDC 260 MA. Tapped 515 V. 215 MA, use or 6 V DC INPUT-500 V. 175 MA. While they last—DM-42-Excel. Condition. \$4.95
Brand New

MG-149F Inverter, 24 VDC input, 115AC, 400 cycles, 500 VA single phase. \$15.95
Exc. \$9.95
Used \$9.95
RS-38 Navy Carbon Hand Mike.
Exc. \$2.45 ea.
I-96A Signal Generator 100-156 Mc, complete w/cords and cables, like new \$69.50
RAX Navy Aircraft Receiver 200-1500 Kc. Used exc. \$17.95

MN-26-C—Remote Control Navigational Direction finder and communication receiver. Manual DF in any one of three freq. bands, 150 to 1500 KC. 24V. Self contained dynamotor supply. Complete installation, including receiver, control box, loop, azimuth control, Left-Right Indicator, plugs, loop transmission line and flex. shafts, oper. & main. manual. Ideal for use in boats, etc.
BRAND NEW \$39.50
MN-20-E Loop 4.95
MN-52-CRANK Drive, New 2.50
MN-28-C New 4.95
MN-26-C Revr., New 19.95
MN-40-E Azimuth Indicator, New 9.95
DYNAMOTORS for above, 12VDC, MN-26 9.95

METER—3"-0.5 Ma. 270° Indication—By Pass Shunt and add scale. Excellent Condition \$1.25
Five for \$5.00

KOPELOVE SURPLUS VALUES

TS/92 AMPLIFIER ALIGNMENT UNIT
20-250 mc. 110 volt, 60 cycle power supply included.
only \$19.95
TS/170-ARNS TEST OSCILLATOR

A complete test transmitter or signal generator for Glide Slope Receivers or other UHF applications. 300 mc range. Modulated 80 to 150 cycles. Used with AN/ARNS Only \$14.95
HEAVY-DUTY AIR PUMP Complete with hose, gauge, moisture absorption unit. Ideal for all kinds of manual air pump applications Only \$5.95
FREE! Send for bulletins of hundreds of surplus items.

All items shipped FOB our warehouse. On C.O.D.'s include 25c with order. Ohio residents add 3% sales tax. All items subject to prior sale.
KOPELOVE ELECTRONICS COMPANY
Dept. RN-357, 1919 East First Street, Dayton 3, Ohio

college grads get ahead faster!

... have higher incomes ... advance more rapidly. Grasp your chance for a better life. Share rewards awaiting college-trained men. Important firms visit campus regularly to employ Tri-State College graduates. Start any quarter. Approved for Vets.

Bach. Sc. degree in 27 months
Complete Radio Eng. courses (TV, UHF, FM, Electronics). Also Mech., Civil, Elec., Chem., Aero., Eng. 36-months in Bus. Adm. (Gen. Bus., Acctg., Motor Transport Mgt.). Superior students faster. More professional class hours. Small classes. Enrollment limited to 150. Beautiful campus. Well-equipped labs. Prep courses. Enter Mar., June, Sept., Jan. Earnest, capable students (whose time and budget require accelerated courses and modest costs) are invited to write Jean McCarthy, Dir. Adm., for Catalog and "Your Career In Engineering and Commerce."

TRI-STATE COLLEGE
1637 College Avenue Angola, Indiana

REDMOND BLOWER

110V. 60 cyc. .3 Amp. 1600 Rpm. 3 3/4" Blower wheel—Outlet 2" Diameter. Suitable for cooling Transm. tubes, etc. . . . ea. **\$7.95**
2 for \$15.00

SMALL BLOWER—Operates on 12 V. to 24 V. DC or 24 V. to 36 V. AC. . . . ea. **\$2.95**

SMALL PIONEER DYNAMOTORS
Ideal for Amateur or Commercial Service 5.5 to 6 volt DC input—output 400 volts at 175 MA cont. or 275 MA intermittent duty. Comes complete with A & B filters. RF shield filter. Intercom. . . . ea. **\$14.95**
cooling fan. . . . each

DYNAMOTOR STARTING RELAY
12V DC coil. Solenoid type fully enclosed. Will easily handle 50 amps. Contacts and mounting winding isolated from ground. . . . ea. **\$1.75**
2 for \$3.00

MARION 2 1/2" METER
Basic 0-1 mil has dual scale. 0-100 ma and 0-500 VDC. Complete with 500 Volt Meter **\$3.95**
Multiplier

MARION 3 1/2" METER
0-150V. DC. Basic 0-1 mil. additional 1 mil scale supplied. . . . ea. **\$3.95**

REVODEX MICROMETER DIAL
1" Diameter dial. Satin Chrome plated. Grad. 0-100 div. Black face front Grad. 1-10. Actually counts 1000 div. or 10 turns. Contains hardware and full instructions. For rotary inductors, helipot, or any other device with 1/4" shaft. . . . ea. **\$2.95**

Filament Transformer
Pri. 110V. 60 c. Secondary 6.3V @ 10 amps. Good quality. . . . ea. **\$1.65**

G. E. RELAY CONTROL
(Ideal for Model Controls, Etc.)
Contains a stamper, midget 8,000 ohm. relay (trips at less than 2 MA), high impedance choke, bi-metal strip, neon pilot and many useful parts. The sensitive relay is worth much more than the total 10
low price of ea. **\$9.25**

RELAYS
Sealed Claire SPST. Norm. closed 3000 ohm coil 2 1/4 ma. . . . ea. **95c**
Claire Telephone Type 11,300 ohm coil DPDT cont. 10 amp 125V. Seris. 4MA. ea. **\$3.95**
Cutler Hammer Contactor—110V 60 cy. 4 pole s.t. Norm. open 25 amp contacts. Hermetically Sealed Relay Coil 110V AC 60 cy SPDT Contacts 5 Amps. . . . ea. **\$1.85**
12 Volt DPDT DC. . . . ea. **\$1.35**
Relay.
Cramer Time Delay Relay, 220V 60 cy. 45 sec. adj. 2 pole DT. . . . ea. **\$6.95**
G.E. Plug in Relay 5 prong 2000 ohm coil 4 mil. SPDT. . . . ea. **\$1.75**
2 for \$3.00
Telephone type relay 12 V. DC @ 10 ma. triple pole single throw. Normally open. . . . ea. **\$1.25**

OIL CONDENSER SPECIALS BRAND NEW

2 MFD 600 VDC .50	1 MFD 3000 VDC 1.85
4 MFD 600 VDC .75	4 MFD 3000 VDC 3.95
6 MFD 600 VDC .85	4 MFD 4000VDC 14.95
8 MFD 600 VDC .95	6 MFD 4000VDC 16.95
10 MFD 600 VDC 1.05	10 MFD 600 VDC 1.45
12 MFD 600 VDC 1.50	5 MFD 7500 VDC 1.49
2 MFD 1000 VDC .85	1 MFD 10,000
4 MFD 1000 VDC 1.35	2 MFD 10,000 VDC 22.00
15 MFD 1000 VDC 2.95	1 MFD 15,000 VDC 39.95
1 MFD 1200 VDC .45	1 MFD 15,000 VDC 29.50
1 MFD 1500 VDC 1.05	1 MFD 25,000 VDC 49.50
2 MFD 1500 VDC 1.10	5 MFD 330 AC (1000 DC) .95
6 MFD 1500 VDC 1.95	20 MFD 330 AC 2.50
10 MFD 1500 VDC 3.50	8 MFD 680 AC (2000 DC) 2.35
1 MFD 2000 VDC .85	
2 MFD 2000 VDC 1.50	
4 MFD 2000 VDC 3.50	
10 MFD 2000 VDC 6.95	
4 MFD 2500 VDC 4.95	

NEW PANEL METERS
G.E., WESTINGHOUSE, W.E., SIMPSON, etc.

1 1/2" 0-50 Mill	2.95	0-150 Ma (Basic)	3.45
RF with ext.		1.5 Ma	3.45
Thermocouple	3.95	0-1 Amp DC	3.95
2" METERS		0-2 Amp DC	4.95
18-36 Volts DC	1.85	0-500 Volts DC	4.95
0-50 Microamp	2.38	50-0-50 Amps	4.50
0-5 Amps DC	2.38	DC	4.50
0-200 Mill AC	2.35	0-150 Volts DC	3.95
0-150 MA RF	3.49	0-1 Mill	3.95
Int. Thermo	3.49	0-12 V. AC and	
0-9 Amps R.F.	2.95	0-3 V. AC (dual range)	3.95

BUD CE2008
Variable Condenser. Isolantite insulation. Air gap .03 Capacity 300 MMF. Reg. net \$4.65 ea. OUR PRICE **\$1.65**

CHOKE—FULLY CASED

10 HENRY 80 Mill (unshielded)	90c
8 HENRY @ 200 Ma	\$1.95
10 HENRY @ 315 Ma	3.50
3 HENRY @ 630 Ma	3.50
6 HENRY 450 Mill	4.95

Read 'n' Save Bargains
Precision Meter Multiplier—1 Megohm 1% tolerance. . . . ea. **\$1.49** ea.
IRC MPA 1 Meg Resistor 35 Watts. **.85c**
HEINEMANN CIRC. BREAKER
110 V. 60 cy. 20 amps. Curve 4. **1.25**
.01 MMF 1000 VDC MICAS. 5 for .95
.0004 2300 VDC MICAS. 5 for .95
1 MFD Oil Condenser 400 VDC. 20c ea.
Thordarson Filament Transf. pri 115V. 60 cy. Secondary 2 1/2 V. 10 amps. 7500V Insul. 5 V. 9 Amps. **3.25**
Receiving element fits standard W.E. or Conn. telephone handsets **65c**
Filament transf.—pri 115V. 60 cy. sec. 6.3V @ 10 amp. **\$1.65**

All merchandise sold on a 10 day money back guarantee basis

Min. Order \$3.00—25% with Order—F.O.B. New York

PEAK

ELECTRONICS COMPANY
66 W. Broadway, New York 7, N. Y., WO-2-5439

ment line includes pulse generators and r.f. signal generators.

The brochure, entitled "Instruments of Laboratory Precision," is available without charge on written request to the Division.

NEWARK FLYER

Newark Electric Company, 223 W. Madison St., Chicago 6, Ill., has released copies of its "Catalogue-Flyer No. 66" containing 32 pages of special value items in the radio, TV, hi-fi, electronics, and amateur fields.

The flyer lists kits of all types, parts, test equipment, intercoms, books, tubes, switches, ham gear, hi-fi components, speaker and equipment cabinets, tape recorders and record players, and audio components.

Write the distributor direct for a copy of this bargain catalogue.

CONSOLIDATED PUBLICATIONS

Consolidated Electrodynamics Corporation, 300 N. Sierra Madre Villa, Pasadena, Calif., has just issued a series of bulletins of interest to the industry.

The first is a 12-page catalogue (Bulletin 1528) which describes the firm's Series 7-300 galvanometers. Complete specifications and circuit application data are provided. Bulletin 1572 describes the company's pressure pickup repair service. The third (Bulletin 1570) gives full data on the Type 3-131 26-volt d.c. power supply, while Bulletin 1561B provides details on "Datatape," the company's new magnetic tape recording and playback system for recording stress, pressure, temperature, and vibration.

Write the manufacturer direct for any of these bulletins.

MOLDED TUBULARS

General Electric Company, Schenectady 5, N. Y., has announced the availability of a new 8-page publication covering its line of molded "PVZ" tubular capacitors.

The bulletin, designated GET-2671, contains descriptive information and lists ratings and dimensions. These capacitors are for application in computers, missiles, telephone equipment, and other high-grade military and commercial electronic equipment.

Copies of the brochure are available without charge from the company. Please be sure to list the bulletin number.

RCA TUBE MANUAL

A new edition of its Receiving Tube Manual has been announced by the Tube Division of Radio Corporation of America, Harrison, N. J.

Revised, expanded, and brought up-to-date, the new RC-18 manual contains technical data on more than 575 receiving tubes, including types for black-and-white and color television and series-string applications. In addition, more than 75 picture tubes, including color types, are covered.

The manual covers basic tube theory and application information while the

TELEVISION & ELECTRONIC TECHNICIANS

Working for Peanuts?
Join the crusade for the independent serviceman

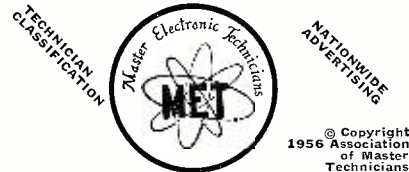

Help stop the squeeze by big business that is attempting to deprive the independent electronic serviceman of his profit and livelihood. If you are interested in becoming a Master Electronic Technician, for complete details, write

ASSOCIATION OF MASTER TECHNICIANS
765 South Street Boston 31, Mass.

MORSE CODE
Learn Morse Code
FAST
by SOUND with
UNCLE SAM'S RECORDINGS
Code signals are transmitted at SLOW speed to allow you time to DUPLICATE them in DIDAH language or with whatever instrument you have to work with . . . also at FAST speed so that you will be FAMILIAR with how they SOUND when you hear them on the air.

ALWAYS READY
TO HELP YOU
TO TEST YOU
TO TEACH YOU
GIVES YOU MESSAGES TO DECODE

Send ONLY \$1.25 for your 7 inch 45 RPM Record
Dealer and Jobber Inquiries Invited
UNCLE SAM RECORDINGS, Dept. C-3
59 E. Van Buren St. Chicago 5, Illinois

STEREOPHONIC RECORD PLAYBACK HEAD IN-LINE MODEL TLD
For conversion, replacement, new equipment. Includes data, schematics for amplifiers, etc.
ORDER FROM:
NORTRONICS, INC.
1015 S. 6th Street
MINNEAPOLIS 4 MINN.

Audio-philie \$19.50

We pay **MOST** the **FASTEST** for:

AIRCRAFT ELECTRONICS	Transmitters	Receivers	INSTRUMENTS
ADF	Indicators	Dynamotors	Air Speeds
			Altimeters
			Compasses
			Gyros

NATCO AVIATION ELECTRONICS
3012-B West Burbank Blvd. Burbank, Calif.

ELECTRONICS

PREPARE FOR A GOOD JOB!
BROADCAST ENGINEER
RADIO SERVICING AUTOMATION

TELEVISION SERVICING
BLACK & WHITE—COLOR

APPROVED FOR VETERANS AND SURVIVORS OF VETERANS
BUILDING AIR CONDITIONED
SEND FOR FREE LITERATURE
BALTIMORE TECHNICAL INSTITUTE
1425 EUTAW PLACE, BALTIMORE 17, MD.

section on electron tube applications has been expanded to include a description of television applications such as tuner circuits, video amplifiers, sync circuits, a.g.c. circuits, and deflection systems. Other sections include information on generic tube types, interpretation of tube data, and electron-tube installation.

Copies of the manual are available from the Commercial Engineering Dept. of the Tube Division for 75 cents a copy or from the company's tube distributors throughout the country.

TV SERVICE COURSE DATA

Supreme Publications, 1760 Balsam Road, Highland Park, Ill., is now offering a free, four-page folder which describes its newly published "Television Servicing Course."

The brochure describes the philosophy behind the preparation of this single-volume training course and tells what type of material has been included. Write the publisher for a copy of the brochure or further details on the course.

MICRO SWITCH CATALOGUES

Micro Switch, a division of Minneapolis-Honeywell Regulator Co., Freeport, Ill., has issued two new catalogues of interest to the industry.

The first is a six-page brochure which describes the company's line of heavy-duty precision switches for machine tools and other industrial equipment. The second publication is a 24-page catalogue (No. 77) covering enclosed switches for airborne equipment.

Copies of either or both of these new publications are available on request direct to the manufacturer.

CLOSED-CIRCUIT TV GEAR

The Broadcast & Television Equipment Department of Radio Corporation of America, Camden 2, N. J., has issued a 28-page booklet covering its monochrome and color TV equipment for closed circuit and on-the-air applications.

The brochure points out how inter-city sales meetings, conferences, and demonstrations can be handled using closed-circuit networks in either black-and-white or color. Educational, industrial, medical, and other specialized applications are also covered. The second half of the brochure is devoted to a description of the various items of equipment which comprise the company's line of closed-circuit gear.

RESISTORS AND RHEOSTATS

Hardwick, Hindle, Inc., Newark, N. J., is now offering copies of its "Standard Stock Bulletin 53" covering its entire line of resistors and rheostats.

The information on the line is presented in tabular form for maximum utility and greatest ease of use. Included are vitreous enameled rheostats with insulated shafts and mounting bushings, fixed and adjustable

March, 1957

FREE 3in-1 PRECISION SCREWDRIVER SET WITH EVERY ORDER

regardless of size!

ALL TUBES UNCONDITIONALLY GUARANTEED FOR 1 YEAR

take your pick any assortment

100 receiving tubes **\$38**

On orders of less than 100 tubes — 41c each

BRAND NEW TV PICTURE TUBES

RCA and DUMONT Licensed

Partial Listing No dud required

Type	T.M. Price
10BP4	\$10.95
12LP4	12.95
12QP4	10.00
14CP4	15.25
15DP4	16.95
16CP4	18.50
16FP4	19.25
16KP4	17.00
16RP4	\$17.00
17BP4	19.00
17GP4	21.00
17LP4	18.00
190A4	22.00
20CP4	24.00
21ALP4A	24.00
21EP4	24.00

Picture tubes F.O.B. PASSAIC, N. J. via Railway Express

PRETESTED TUBES—INDIVIDUALLY BOXED

024	6AU6	6SH7	12BA8
1B3GT	6AU6GT	6SJ7GT	12BE6
1H5GT	6AV5	6SW7GT	12A27
1LC5	6AV6	6SL7GT	12BH7
1LNS	6AX4GT	6SN7GT	12BY7
1NSGT	6AT5	6XQ7	12SA7
1Q5GT	6AM4GT	6SR7	12SG7
1R5	6BA6	6T8	12SJ7GT
1S4	6BC6	6U8	12SK7
1S5	6BE6	6V3	12SL7GT
1T4	6BG60	6V6GT	12SN7GT
1TSGT	6B16	6W4GT	12SQ7
1U4	6BK5	6WG6T	12SR7
1U5	6BK7	6X4	191B
1X2	6HL7GT	6X5GT	191HG6G
3Q4	6D0GT	6Y6G	25H6GT
3S4	6D7	7C5	25L6GT
3V4	6DY5G	7C8	25Z5
5U4G	6E27	7E7	25Z6GT
5V4Q	6C4	7F7	35B5
5Y3	6CB6	7FB	35C5
6AP4	6CD6G	7N7	35L6GT
6AC7	6F6	12AL5	35W4
6AG5	6H6GT	12AT7	35Y4
6AG7	6J5GT	12AUG	36Z5GT
6AF4	6J6	12AU7	50A5
6AK5	6R6GT	12AV6	50B5
6AL5	6L5	12AW7	50C5
6AQ5	6S4	12AX7	50L6GT
6AS5	6S8GT	12AX4GT	117Z3
6AT6	6SA7	12B77	

Free Postage on all prepaid continental U.S.A. orders. 50c handling charge on all orders under \$5.00. 25% deposit on all C.O.D. Subject to prior sale.

TUBE MART

DISCOUNT HOUSE

Pracott 3-0330

The Lokpot Bldg. Passaic, N. J.

BUILD 16 RADIO

Reg. U. S. Pat. Off. CIRCUITS AT HOME WITH THE NEW DELUXE PROGRESSIVE RADIO "EDU-KIT"

A Practical Home Radio Course ONLY \$22.95

FREE: Set of Tools, Soldering Iron, Tester, Membership in Radio-T Club; Consultation Service; TV Radio, Hi-Fi Quiz Books, FCC Amateur License Training, Printed Circuitry, Pliers-Cutters, Alignment Tool.

The "Edu-Kit" offers you an outstanding PRACTICAL HOME RADIO COURSE at a rock-bottom price. You will learn radio theory, construction and servicing. You will learn to build radios, solder and wire in a professional manner, trouble-shoot radios. You will build 16 Receivers, Transmitters, Code Oscillator, Signal Tracer and Signal Injector circuits, and learn how to operate them. You will receive an excellent background for TV. In brief, you will receive a basic education in Electronics and Radio, worth many times the small price you pay.

You will receive all parts, tools and instructions necessary to build 16 different radio and electronic circuits, each guaranteed to operate. Our kits contain tubes, tube sockets, variable, electrolytic and paper dielectric condensers, resistors, tie strips, coils, hardware, tubing, punched metal chassis, Instruction Manuals, etc. In addition, you receive Printed Circuit materials, including Printed circuit chassis, special tube sockets, hardware and instructions. You also receive a useful set of tools, pliers-cutters, an alignment tool, a professional electric soldering iron, and a self-powered dynamic Radio and Electronics Tester. The "Edu-Kit" also includes Code instructions and the Progressive Code Oscillator. You will also receive lessons for servicing with the Progressive Signal Tracer and the Progressive Signal Injector, TV, Radio, Hi-Fi and Quiz Books, FCC Amateur License Training.

All parts, components, etc. of the "Edu-Kit" are 100% unconditionally guaranteed, brand new, carefully selected, tested and matched. Everything is yours to keep. The complete price of this practical home radio and electronics course is only \$22.95. Sold only by Progressive "Edu-Kits".

You will learn to trouble-shoot and service radios, using the professional Signal Tracer and the unique Signal Injector, and the dynamic Radio and Electronics Tester. Our Consultation Service will help you with any technical problems.

J. Stasitis, of 25 Poplar Pl., Waterbury, Conn., writes: "I have repaired several sets for my friends, and made money. The "Edu-Kit" paid for itself. I was ready to spend \$240 for a Course, but I found your ad and sent for your Kit."

PROGRESSIVE "EDU-KITS" INC. 497 UNION AVE. DEPT. 63-E, BROOKLYN 11, N. Y. ORDER FROM AD—RECEIVE FREE BONUS RESISTOR & CONDENSER KITS WORTH \$7

90-DAY UNCONDITIONAL MONEY-BACK GUARANTEE I enclose full payment of \$22.95 for "Edu-Kit" set postpaid. I will pay postman \$22.95 plus postage for "Edu-Kit" sent COD. Rush me, FREE descriptive literature concerning "Edu-Kit." Also send me FREE valuable Radio, TV literature.

NAME _____ ADDRESS _____

TV TELLS HOW TO ANSWER RADIO RADIO T.V. QUESTIONS SERVICE LIBRARY



HERE IS LATE INFORMATION IN A HANDY FORM FOR RADIO AND TELEVISION REPAIRMEN, SERVICEMEN AND STUDENTS

AUDELS T.V. RADIO SERVICE LIBRARY—Over 1500 Pages—1085 Illustrations & Diagrams. 1001 Important Facts & Figures on Modern T.V., Radio Electronic Devices at your fingers' ends Highly Endorsed.

INCLUDES TRANSISTORS and Transistor Circuits, Rectifiers, Record Changers, P. A. Systems, Tape Recorders, Photograph Pick-ups, F.M., Auto Radio; Radio Compas, Short Wave, Radar, etc.

ASK TO SEE IT! IT WILL PAY TO KNOW—The Basic Principles—Construction—Installation—Operation—Repairs—Trouble Shooting Shows How to get Sharp, Clear, T.V. Pictures. In-stall Aerials—How to Test Explains Color Systems, Methods of Conversion, Terms, etc. Includes Ultra High Frequency—Valuable for Quick Reference and Home Study.



\$8 COMPLETE 2 VOLUMES Get this Information for Yourself 7 DAY TEST—PAY ONLY \$1 MO.

MAIL ORDER—AUDEL, Publishers, 49 W. 23 St., New York 10, New York

Mail AUDELS T. V. RADIO SERVICE LIBRARY (2 Volumes) \$8 on 7 days free trial. If O. K. I will remit \$1 in 7 days and \$1 monthly until \$8 is paid. Otherwise I will return them.

Name _____ Address _____ Occupation _____ Employed by _____

RN 3

ISOLATION TRANSFORMER BARGAIN
(110V.-110V.)

Fully shielded with line cord and receptacle.
200 WATTS . . . \$4.75 **2 for \$8.95**

POWER TRANSFORMER BARGAIN

Primary 115 V. 60 cy. Sec. 425-0-425V
@ 200 ma., 6.3 V. @ 5 amp., **\$3.99**
5 V. @ 4 amp. Standard mounting, **2 for \$7.50** ea.

ZENITH REMOTE CONTROL
110 V A.C.—60 cy.

Assembly consists of a motor driven gear reduction unit with hand control reversing switch at end of 17 foot cable. Instant start, stop and reverse. 4 RPM. ea. **\$9.95**

OIL CONDENSER .001 15,000 VDC
4x4x4 MFD **95c** Ceramic Condenser 2 for **99c**
600 VDC

WESTERN ELECTRIC 115 V AC RELAY
Stepping relay 44 steps, 115 V 60 Cyc Coil
6-12 Volt DPDT, 10 Amp Contact **\$4.95**
coil. \$1.89 ea.; 3 for \$4.95

VEEDER ROOT COUNTER **VACUUM CONDENSER**
5 Digit ratchet counter, Resettable. EIMAC—Type VC50-32
\$2.95 50 Mmf @ 32,000 VDC **\$7.95**

G. E. RELAY CONTROL

(Ideal for Model Controls, Etc.)
Contains a sigma midget 8,000 ohm, relay (trips at less than 2 MA), high impedance choke, bimetal strip, neon pilot, and many useful parts. The sensitive relay alone is worth much more than the total low price of **\$1.10** Each 10 for **\$9.25**
FREE Model Control Book with Purchase of 10.

SENSITIVE PLUG-IN RELAY **WESTON**
DPDT 14,000 OHM COIL 0-1 MILL METER
Plugs Into Octal Socket **\$1.99** each 270° SCALE 2" CASE
MODEL #1329 ea. **\$4.95**

12-14 VOLT DYNAMOTOR **ANTENNA RELAY**
375 Volt at 150 Ma. 12 Volt DC., DPDT plus
with Filter **\$4.95** extra SPST 10 amp contact. Low loss
ins. ea. **\$1.39**

PANEL METERS
2" METERS 3" METERS
150-0-150 Micro-amp **\$4.95** 0-10 Milliamp. **\$2.95**
DB 0 to +15. **2.95** 0-150 Milliamp. **3.95**
0-500 Volts DC. **3.95**
0-15 Amps DC. **2.95**

OIL CONDENSER BARGAINS
1 mfd 600 VDCs .25 8 mfd 1000 vdc. \$1.35
2 mfd 600 VDC .45 12 mfd 1000 vdc. 1.59
4 mfd 600 vdc. .75 6 mfd 1500 vdc. 1.95
8 mfd 600 vdc. .95 2 mfd 2000 vdc. 1.50
10 mfd 600 vdc. .99 3 mfd 2000 vdc. 2.25
1 mfd 1000 vdc. .60 4 mfd 2000 vdc. 2.95
2 mfd 1000 vdc. .75 4 mfd 5000 vdc. 14.75
4 mfd 1000 vdc. 1.25 1 mfd 3000 vdc. 1.85
2 mfd 10KV DC. 27.50

BIG BARGAINS IN LITTLE TUBE
Kit of 25 WIRE WOUND RES. 5 to 50 watt. \$1.95
Kit of 10 TRANSMITTING NIPAS. 1.50
500 MMF CERAMIC CONDENSERS. 1.50
15 MEG 1% METER MULTIPLIER. 1.49
1 MFD 400VDC OIL COND. 10 for .95

Min. Order \$3.00—25% with order F.O.B. New York
10 DAY GUAR. PRICE OF MDSE. ONLY

ADVANCE ELECTRONICS COMPANY
6 WEST BROADWAY, NEW YORK 7, N. Y.
Phone REctor 2-0270

NEW! 4-Transistor Pocket Radio!

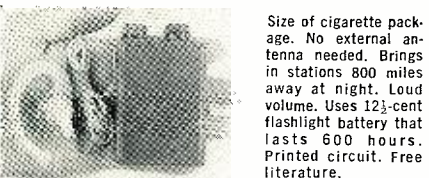

Size of cigarette package. No external antenna needed. Brings in stations 800 miles away at night. Loud volume. Uses 12½-cent flashlight battery that lasts 600 hours. Printed circuit. Free literature.

Complete kit, \$23.50. Fully wired, \$29.50.

2-transistor kit, \$15.50. 1-transistor kit, \$9.50.

Order now from

GARDINER ELECTRONICS CO., Dept. 11
2545 East Indian School Road • Phoenix, Arizona

vitreous enameled resistors with mounting brackets, the company's "Blue Ribbon" line, and the 10- and 20-watt fixed vitreous enameled types. Copies of this bulletin are available without charge from the manufacturer.

COMPUTER COMPONENTS

Sylvania Electric Products Inc., 1740 Broadway, New York 19, N. Y., has issued an elaborate 64-page book covering its line of specially designed tubes and components for electronic computers.

Data on twin-triode and multigridded computer tubes is provided along with semiconductor computer components, silicon point-contact computer diodes, computer crystal diodes, computer transistors, and special purpose tubes for computers.

Physical and electrical specifications are given on all the components along with pertinent application data. Copies of this elaborate reference manual are available on letterhead request from Dept. K40P of the company. —50—

PHOTO CREDITS

- 38. JFD Manufacturing Co.
- 43. Bell Telephone Laboratories
- 44. Gerald F. J. Tyne
- 45. R. McV. Weston
- 52, 53. University Loudspeakers, Inc.
- 54, 56, 57, 59 (center), 144. General Electric Company
- 59 (left) Radio Corporation of America
- 59 (right) International Instrument, Inc.
- 62. Acoustic Research, Inc.
- 63. Jensen Manufacturing Co., Inc.
- 86. U. S. Army
- 95. Irving Kaufman
- 108. Browning Laboratories
- 109. Collins Audio Products
- 121. Westinghouse Electric Corp.
- 148. Lafayette Radio
- 159. Stanford Research Institute

ERRATA

In the circuit diagram for "A Densitimer for the Darkroom" on page 51 of the December, 1956 issue, the regulator tube (V₁) may be either an OA2 or an OD3/VR150.

In the article "All-Transistor Amateur Transmitter" on page 62 of the December, 1956 issue, the tank coil, L₁ should be of Miniductor #3007 instead of #3003 as indicated in the parts list.

In the schematic diagram of "A Professional Tape Recording Amplifier for Home Hi-Fi Systems" on page 73 of our December, 1956 issue, an incorrect value was given for R₂. This value should be 33,000 ohms instead of 10 megohms.

Some readers have experienced difficulty in locating the Pentron tape deck and oscillator coil. The tape deck has recently been replaced by the redesigned Pentron TM-56, which is similar except for the single lever shift control. This current production model is available at parts suppliers and may be used instead of the 9T-3M. The oscillator coil is available from Pentron Corp., 777 S. Tripp Ave., Chicago 24, Ill. as the part No. 311-A-13.

There is an error in the block diagram (Fig. 3) of the article "Sylvania Color TV Circuits" (page 54, February, 1957 issue). The line originating at the chroma amplifier and feeding to the a.g.c. amplifier and sync amplifier should actually originate at the first video amplifier. In addition, the inconvenience of using a mirror for convergence adjustment, mentioned in the article, can be overcome easily. Since the convergence and other controls on the top front of the set are actually located in a removable box, the box can be removed and placed in front of the set during adjustment so that the screen can be observed directly. Later production models use a tuner different from the one shown in Fig. 1 and positioned in a slightly different way.

BC-1016 Recorders—Less control head and inkers—in good condition—complete with tubes **\$29.95**
BC-659 Transmitter Receivers, complete with tubes—less crystals—in good condition. **\$27.50**
TCS-4 to 14 Collins Receiver Transmitters, complete with cables, remote control units, antenna coils, microphones—less power supplies—Used—good condition. **\$59.50**
TCB-1 (16G5) Collins Transmitters with pre-amplifiers, in good condition. **\$135.00**
UG Teletype terminal portable multichannel tone link system—Excellent condition. **\$135.00**
VG-PPI Repeaters—Excellent appearing condition. **\$185.00**
MN-5 Transceivers—30 to 42 mc with control leads and tubes. Good appearing condition. **\$43.50**

TEST SETS
TGI-3CA Signal Generators—79B Communications Pulse Generators—TS-10, TS-11, TS-12, TS-13, TS-35 and 35 A TS-36, TS-102, TS-110, TS-155 A TS-182, TS-184, TS-191, SG-14/U, SG-18, and many other various test units—transformers—resistors—potentiometers, capacitors, rotary equipment, etc.

SURPLUS ELECTRONICS OUR SPECIALTY:
Write for our Bulletin
WRITE—WIRE—PHONE
your requirements.
Quantity prices available on request.
Prices fob Dorchester, Mass., and subject to prior sale.

ELECTRO CRAFT COMPANY
5 Milton Avenue
Dorchester 24, Massachusetts
TAIbot 5-3410 — TAIbot 5-3451

EASY TO LEARN CODE

It is easy to learn or increase speed with an Instructograph Code Teacher. Affords the quickest and most practical method yet developed. For beginners or advanced students. Available tapes from beginner's alphabet to typical messages on all subjects. Speed range 5 to 40 WPM. Always ready—no QRM.



ENDORSED BY THOUSANDS!
The Instructograph Code Teacher literally takes the place of an operator-instructor and enables anyone to learn and master code without further assistance. Thousands of successful operators have "acquired the code" with the Instructograph System. Write today for convenient rental and purchase plans.

INSTRUCTOGRAPH COMPANY

4711 SHERIDAN ROAD, CHICAGO 40, ILLINOIS

ELECTRIC BRAIN KIT

Can you think faster than this machine?

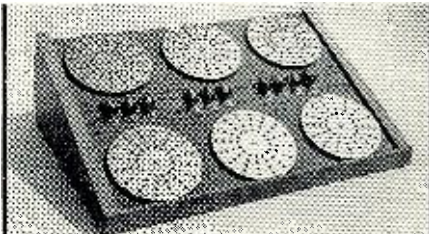

Control Panel of GENIAC set up to do a problem in check valve research.

Be careful before you answer. GENIAC the first electrical brain construction kit is equipped to play tic-tac-toe, cipher and encipher codes, convert from binary to decimal, reason (in syllogisms) as well as add, subtract, multiply and divide. Specific problems in a variety of fields—actuarial, policy claim settlement, physics, etc., can be set up and solved with the components. Connections are solderless and are completely explained with templates in the manual. This covers 33 circuits and shows how new ones can be designed.

You will find building and using GENIAC a wonderful experience; one kit user wrote us: "this kit has opened up a new world of thinking to me." You actually see how computing, problem solving, and game play (tic-tac-toe, nim, etc.) can be analyzed with Boolean Algebra and the algebraic solutions transformed directly into circuit diagrams. You create from over 400 specially designed and manufactured components a machine that solves problems faster than you can express them.

Schools and colleges, teachers of science or math, engineering, philosophy or psychology will find these excellent demonstrators of circuitry, solutions in symbolic logic, theory of numbers, cryptistics, and automation.

SEND for your GENIAC kit now. Only \$19.95 with over four hundred components and parts, fully illustrated manual and wiring diagrams. We guarantee that if you do not want to keep GENIAC after one week you can return it for full refund plus shipping costs. Add \$1 west of the Miss. \$21.95 outside U.S.A.

Dept. RT-37, Oliver Garfield Co.
126 Lexington Ave., N. Y. 16, N. Y.

Classified

RATE: 50¢ per word. Minimum 10 words. May issue closes March 11th. Send order and remittance to: RADIO & TELEVISION NEWS, 366 Madison Ave., N. Y. C. 17.

RADIO ENGINEERING

COMPLETE radio, electronics theory & practice; television; broadcasting; servicing; aviation, marine, police radio. 18 or 21 months. Catalog. Valparaiso Technical Institute, Dept. N, Valparaiso, Ind.

DESIGN—Construction Service or Consultation on any type of Electronic Device. Electronic Service Engineers, Poteau, Oklahoma.

FOR SALE

DIAGRAMS! Repair Information! Radios—amplifiers—recorders \$1.00. Televisions \$1.50. Give make, model, chassis. TV Miltie, Box 101RA, Hicksville, New York.

DIAGRAMS for repairing radios \$1.00. Television \$2.00. Give make, model. Diagram Service, Box 672-RN, Hartford 1, Conn.

TUBES—TV, Radio, Transmitting And Industrial Types At Sensibly Low Prices. New, Guaranteed, 1st Quality, Top Name Brands Only. Write For Free Catalog or Call Walker 5-7000, Barry Electronics Corp., 512 Broadway, New York 12N, N. Y.

100 KILOCYCLE Crystal Calibrator \$4.50. 100 KG PRZ-6A Crystal \$6.95. Allied Electronics, 111 North 41st, Omaha, Nebraska.

TELEVISION Antenna Towers, Heavy Duty self-supporting 50 feet high. May be extended to 100 feet with additional sections and Guy Wires, #23AT400 net \$89.95. Triangular heavy duty Mast Roof Mounts \$3.50. Tubular Lead 3¢ per foot. Ground Rods 6 for \$5.00. Three-Way Antenna Switches Taco #873 \$1.95. Couplers, VEE-DX Hi-Lo \$1.00. IFD Hi-Lo-UHF \$1.00. Crown Roller Bearing Guy Ring \$3.50. Penn GRA-140 \$1.00. 100 Feet Rotor Cable \$2.50. Allied Electronics, 111 North 41st, Omaha, Nebraska.

LISTEN in on Police, Fire, Forestry, Pipeline, Taxi, Civil Defense, Marine and other 2-way radio systems with Monitoradio. Prices \$49.95 up. Write for free descriptive literature. Allied Electronics, 111 North 41st, Omaha, Nebraska.

MICROPHONES, 35 Types on hand, all prices. Allied Electronics, 111 North 41st, Omaha, Nebraska.

COMPLETE Television Sets \$11.95. Jones TV, 1115 Rambler, Pottstown, Pa.

DISGUSTED with "HI" HI-FI Prices? Unusual Discounts on all your High Fidelity requirements. Write now. Key Electronics Co., 120 Liberty St., N. Y. 6, N. Y.

5 KVA Variacs \$50, 1 KVA Transformers 440/220 to 220/110 \$12.50, #18 insulated wire 1¢ ft. 10,000 ft. 100 lb. roll \$35, 6 KVA Saturable Reactors \$60, 5 mfd 600 V Pyranol Condensers \$5. Scientific Equipment, 106 Verbena, Oak Ridge, Tenn.

ONE of the original General Electric FM receivers covering the old band 44-48 mc. \$10.00. Box 51 % RADIO & TV NEWS.

NEW—Limpander model 100, the Consonant Amplifier-Limiter with high speed noise squelch. Electronic Systems Engineering Company, 903 Cravens Building, Oklahoma City, Oklahoma.

NEW S.C.R. 522. With tubes and P.E. 98 \$29.95. Used excel. \$17.95. P.E. 98 new \$5.45. P.E. 94 new \$2.25. D.M. 35 new \$9.95. Boyds Surplus Sales. Box 124, Mt. View, Alaska.

WANTED

SELL Your Way To Wealth! Wanted Surplus military and commercial aircraft electronics: ARN-7, ARC-3, 51R-3, APN-9, RC-348, RTA-1B, BC-788, I-152, L-5, MN-53, 18S-4, BC-610, CW-3, test equipment and All Vacuum Tubes. Top prices paid. For fattest checks—sell to Rex! Bob Sanett, W6Rex, 1524 S. Edris Drive, Los Angeles 35, California. Phone: REpublic 5-0215.

AN/APR-4, AN/APR-9, other "APR-," "ARR-," "TS-," ARC-1, ARC-3, ART-13, everything surplus; Tubes, Manuals, Laboratory equipment. Describe, price in first letter. Engineering Associates. 434 Patterson Rd., Dayton 9, Ohio.

PLATINUM Electronic Scrap. Highest prices. Estimates by mail. Satisfied customers from coast to coast. Ship with perfect confidence. Cash sent by return mail. Noble Metals Co., Box 1113, Santa Monica, California.

CYLINDER and old disc phonographs. Edison Conqueror, Idelia, and Oratorio models. Berliner Gramophones and Zono-o-phones, Columbia cylinder Graphophones, and coin-operated cylinder phonos. Want old catalogues and literature on early phonos prior to 1919. Will pay cash or trade late hi-fi components. Box 50 % RADIO & TELEVISION NEWS.

WANTED: Receiver R5/ARN-7, MN-62A Transceivers, RT18/ARC-1, AN/ARC-3, BC-788C, I-152C, Collins, Bendix equipment, Test Sets, Dynamometers, Inverters. We pay highest prices. Advise quantity, condition, price first letter. Aircraft Radio Industries, Inc., 15 East 40th St., New York City, telephone Lexington 2-6254.

ART-13/T47A Transmitters, \$175.00; ART-13/T47 Transmitters, \$125.00; BC-788 C Altimeters, \$175.00; ARC-3 Transceiver Complete, \$325.00; R5/ARN-7 Radio Compass, \$175.00; BC-348 Rec'r Modified, \$25.00; BC-348 Rec'r Unmodified, \$50.00; ARC-1 Transceiver, \$300.00; BC-342 Rec'r, \$50.00; BC-312 Rec'r, \$40.00; I-152-C Indicator, \$50.00. Ship Via Express, C.O.D. Subject To Inspection To H. Finnegan, 49 Washington Ave., Little Ferry, N. J.

CASH Paid! Sell your surplus electronic tubes. Want unused, clean transmitting, special purpose, receiving, TV types, magnetrons, klystrons, broadcast, etc. Also want military & commercial lab test and communications gear. We swap too, for tubes or choice equipment. Send specific details in first letter. For a fair deal write, wire or telephone: Barry, 512 Broadway, New York 12, N. Y. Walker 5-7000.

REPAIRS AND SERVICING

HIGH Fidelity Speakers Repaired. Amprite Speaker Service, 70 Vesey St., N. Y. 7, N. Y. Ba. 7-2580.

TV TROUBLES? Send Model Symptoms and \$2.00 for Analysis. Electronic Service Engineers, Poteau, Oklahoma.

HEATH Kit Computers Wired-Tested. Electronic Service Engineers, Poteau, Oklahoma.

TAPE RECORDERS

RECORDERS. Tape, Hi-Fi. Wholesale Prices. Catalogue. Klarston, 215 E. 88th St., N. Y. C. 28.

PRE-RECORDED Tapes, Recorders, Accessories. Unusual Values, Catalog. Efesco Sales, 270-E Concord Avenue, West Hempstead, N. Y.

TAPE Recorders, Tape. Unusual Values. Free catalog. Dressner 69-02 R, 174 St., Flushing 65, N. Y.

WHOLESALE Catalogue: Recorders. Tapes. Radios. Records. Phonographs. Towers—155, Philadelphia 5.

HELP WANTED

RADIO and Electrical Mechanics Electronic or aircraft or commercial experience. Must know AC/DC fundamentals. Radio Mechs. must have 2nd Class Radio-Telephone License. 90% discount travel worldwide. Excellent life insurance, health and retirement plans. Steady promotion. N.Y. International airport, rotating shifts. Write Employment Office: Pan American Airways 28-01 Bridge Plaza North, Long Island City, New York.

CORRESPONDENCE COURSES

USED Correspondence Courses and Books sold and rented. Money back guarantee. Catalog free. (Courses bought.) Lee Mountain, Pisgah, Ala.

INSTRUCTION

ENGINEERING Degrees earned by home study. (Residential courses also available.) Pacific International University, (American College of Engineering), Box 27724-C, Hollywood 27, Calif.

MISCELLANEOUS

EAVESDROP with a pack of cigarettes, miniature transistorized radio transmitter. Complete Diagrams and Instructions. \$1.25. Q. Carrier Co., 734 15th St., N.W., Washington, D. C.

TELEPHONE Extension in your car. Answer your home telephone by radio from your car. Complete diagrams and instructions. \$1.25. Q. Carrier Co., 734 15th St., N.W., Washington, D. C.

DECALS—Trademarks, Service, Sales, etc. Write Allied Decals, Inc., 8378 Hough, Cleveland, Ohio.

MARINE Crystals. Airmailed \$2.95. Quantity discounts. Cap, 3023.5, etc. Since 1933. C-W Crystals, Box 2065, El Monte, Calif.

TRADE-in TV sets. Ship anywhere. 10"-\$8, 12"-\$12, 16"-\$18, 17"-\$20. Send money order for immediate shipment. Justis Bros. Newport, Del.

HQ for the 5 TOP QUALITY brands of

TUBES

AT SENSIBLE PRICES!

• 90-Day RETMA guarantee • Brand New
• Individually boxed • First quality only
WRITE FOR LATEST RECEIVING AND TV TUBE PRICE LIST, FREE!

1B35	..53.35	307A	..S .60	1620	..\$3.50
1Q22	..44.50	355A	..11.00	1625	..1.00
2C35	..2.25	357A	..14.00	6510	..1.00
2C35	..2.00	371B	..75	2051	..65
2C39A	..11.00	403A	..1.20	5517	..1.35
2C51	..9.75	403B	..3.25	5636	..2.95
2C51	..9.75	404A	..12.50	5636A	..2.95
2D21	..70	416A	..25.00	5642	..1.00
2E24	..2.34	416B	..39.00	5643	..4.95
2K45	..35.00	417A	..75	5646	..5.00
2K45	..35.00	417A/B	..50	5651	..1.40
2K55	..15.00	5842	..12.00	5654	..1.40
3B24	..1.50	4450TH	..44.00	5676	..4.50
3B24W	..4.75	KU-610	..3.50	5670	..1.15
3B29	..1.95	WL/655/	..90.00	5675	..8.00
3C23	..3.95	GL673	..12.50	5687	..1.85
3C31	..1.00	701A	..1.85	5691	..4.75
3C45	..7.00	703A	..1.35	5692	..4.75
3130	..25.00	723A	..7.50	5703WA	..4.50
3K2000LK	..Write	723A/B	..3.00	5718	..2.00
*4-65A	..15.00	750TL	..35.00	5719	..2.00
*4-125A	..30.25	800	..90	5725	..2.00
*4-250A	..35.00	802	..2.25	5726	..75
*4-400A	..45.00	803	..2.00	5727	..1.25
B24/ELC3	..4.50	803	..2.00	5749	..1.25
4C35	..13.50	805	..5.00	5763	..1.25
4PR60A	..40.00	807W/	..1.10	5814	..1.00
5C22	..27.00	5933	..1.75	5840	..4.50
6AK5W	..1.40	813	..8.50	5876	..8.00
6B24	..15.00	814	..1.00	5883	..2.95
6C21	..13.50	815	..2.00	5910	..45
6J4	..1.75	816	..1.50	5915	..50
6J6W	..7.75	816	..7.25	6111	..4.95
15E	..1.20	837	..1.25	6112	..4.95
FG32	..4.35	838	..70	6130/	..6.00
*3245	..5.45	845	..3.00	6245	..6.00
VC50/32KV	..8.00	866A	..1.20	6161	..52.50
RK-60/	..1.40	872A	..1.00	6189	..2.50
1641	..1.25	918	..1.10	6201	..3.00
RK65	..7.50	927	..1.00	6240	..30.00
5D23	..2.25	930	..1.00	6539	..9.00
HK872 or	..35	954	..40	8008	..3.25
73	..35	955	..40	8020	..1.00
VK34	..3.95	956	..35	9001	..75
FXR-130	..5.00	956	..35	9002	..95.00
203A	..2.50	958A	..35	9003	..1.35
211	..50	991	..25	9004	..30
250R	..2.95	CK1005	..35	9006	..20
HK252	..5.00	CK1007	..45		
GL299	..2.00	CK1026	..2.35		

and many others, over 1000 types in stock! WRITE!

2 COLOR TUBE CARTONS

Keeps your tube stock neat. New safety partition prevents tube breakage. Distinctively lithographed in glossy red and black. The most distinctive tube carton available today. Minimum quantity: 100 of any one size. Write for case lot prices.

SIZE FOR TUBE PER 100
Miniature .6AU6, etc. .51
GT .6SN7, etc. .125
Large GT .1B3, etc. .150
Large G GU45, etc. 2.00

WHITE GLOSSY BOXES
Completely blank. No printing or color. Otherwise same as above. Same high quality, same low prices. Specify "WHITE" when ordering. When color is not stated, 2 color cartons will be shipped.

TUBE STACKERS
White glossy only. Ministacker holds 10 Mini tube cartons; "GT" stacker holds 10 "GT" cartons.
SIZE PER EACH
Ministacker12¢
GT2¢



5" DUMONT SCOPE MODEL 274A AT LESS THAN HALF PRICE!

Genuine Dumont model 274A, 5" oscilloscopes, regularly sold for \$150, now available for LESS THAN HALF PRICE! Look at these features: Frequency response within 50% from 20 to 200,000 cps with recurrent sweeps from 8 to 30,000 cps. Similar X and Y amplifiers and provision for intensity modulation. Portable, light weight. Shpg. wgt. only 35 lbs. Used, clean, checked out and guaranteed.
SPECIAL! F.O.B. N.Y.C. \$65.00

TEST EQUIPMENT BARGAINS!

ABSORPTION WAVEMETER. GEN'L. Radio type 758A 55-400 MCS. (Worth \$40.00) NEW! . . . \$12.50
5" OSCILLOSCOPE. Dumont 208B. Vv. good. 110.00
OSCILLOSCOPE. RCA WO-85A. Vv. good. 195.00
TV XTAL 13 CHANNEL MARKER. Kay "Mega-marker" incl. all 13 xtals. Vv. good. \$49.50
SIGNAL GENERATOR. Measurements Corp. model 78FM. 86-110 Mcs. 30 Kc. deviation. Excellent condition \$175.00

TV Sweep Generators RCA MODEL WR-59A SPECIAL EXCEL. \$75 COND.

TRANSFORMER SPECIAL! 3100-0-3100 volts @ 1/2 amp!

PRIMARY: tapped for 98-104-110-116-123 volts, 60
SECONDARY: 3100 volts each side of center @ 500 ma. 15 KV impregnated mica insulation. Conservatively rated. Meas. 9" L x 8" H x 7 1/2" W. New, guaranteed. Shpg. wgt. 60 lbs. \$34.50

WRITE FOR "BARRY'S GREEN SHEET." FREE!

TERMS: 25% deposit with order, balance C.O.D. All merchandise guaranteed. F.O.B. N.Y.C.

Subject to Price Variation & Stock Depletion

BARRY ELECTRONICS CORP.

512 Broadway, Dept. RN, N.Y. 12, N.Y.
Call Day or Night—24 Hour Phone Service
Phone: Walker 5-7000

NEW BUILT "TAB" POWER SUPPLY

1100VDC @ 200ma Brute Force filter, oil capacitors, Bleeder, Bridge \$66. Rectifiers & Fil 6.3V @ 8A & 125VDC Bias \$48. Kit with chassis \$39. Built Same only 550VDC @ 200ma \$36. Kit \$28. Built 2200VDC @ 200ma DC Supply \$66.

ELECTRONIC FLASH! LUCKY PURCHASE \$59 SHAWLITE 40011 SPECIAL \$20

Assembled & ready to work! Not a Kit. Latest features SUPER CIRCUIT—Low cost flash less than 3¢. Inbuilt AC & Batteries* all in one case, powerful, compact. Guide No. Color 604. B&W 200+. Recycles 2 secds. Limited Qty Special \$20. *Batteries not included. Two (2)/240V \$10.



Photoflash Cond. 525MFD/450V/53W SEC. NEW LOW leakage. Famous mfg. \$6 @ 2/\$11. 6/530, 25/\$100

KITS! KITS!

All Kits Contain Most Popular Values & Sizes

EXTRA: 11 KITS FOR.....\$10

- | | |
|------------------------|----------------------|
| 25 Precision Resistors | 25 Power Resistors |
| 10 Switches | 65 Mica Cond. |
| 75 Knobs | 5 Crystal Diodes |
| 75 Carbon Resistors* | 250 ft. Hookup Wire |
| 36 Panel Lamps | 100 Fuses |
| 10 Electrolytic Cond's | 35 Ceramic Cond |
| 15 Volume Controls | 10 Rotary Switches |
| 25 Tube Sockets | 60 Inductors & Coils |
| 50 Tubular Cond's | 5 Microswitches |
| 500 Lugs & Eyelets* | 10 Wheat Lamps |
| 10 Bathroom Oil Cond's | 40 Insulators |
| 10 Xmit Mica Cond's | * In Plastic Box |
- 1 EACH KIT ONLY..... 99¢

NEW "TABTRON" SELENIUM BRIDGE

Gtd. RECTIFIERS One Yr. FOLLOWING LIST. FULL WAVE BRIDGE

Curr.	18/14	36/28	52/42	130/100
Cont.	Volts	Volts	Volts	Volts
1AMP	\$1.40	\$2.80	\$3.70	\$7.25
2AMP	2.00	3.40	5.30	10.25
3AMP	2.90	4.10	5.75	12.70
4AMP	3.50	4.60	6.25	14.25
6AMP	3.95	6.70	11.25	25.00
10AMP	5.85	11.35	19.40	41.25
12AMP	7.20	14.25	22.00	43.85



VARIABLE 0 TO 6 & 12 VOLT/12 AMP DC Power Supply

Battery Eliminator, Charger, Model RR, Plater, Aircraft, Marine or any DC reg. Extra hvy duty Selenium Rectifier, 2 meters V & A. Designed for continuous service & up to 20 Amps intermittent. Built & ready to work (not a kit). MODEL TG12.....@ \$33.00



"TABTRON" HI CURRENT PWR SUPPLIES

ONE YEAR GUARANTEE Variable 0-28VDC. Completely Built. Incls: Full Wave Selenium Rectifier, Transformer, Variac, Volt & Amp Meters, Switch, Terminals & Fuse, In Hvy duty Steel Cabinet. Standard 115V/60cy Input or 200T and 3 phase to order. SPECIFY.



Sk No.	Cont.	Rating	W-Meters
T28V5A	0-28 VDC	at 5 Amp	\$ 50
T28V12A	0-28 VDC	at 12 Amp	\$125
T28V24A	0-28 VDC	at 20 Amp	\$155
T28V50A	0-28 VDC	at 50 Amp	\$285

New, Unused • Individually Boxed

TUBES FULL RETMA WARRANTY

No Electrical or Mechanical Rejects

0Z4	.45	6AV5	.80	6K6	.45	12AX7	.55
1AX2	.95	6AV6	.45	6SA7	.45	12BA6	.30
1B3	.65	6AX4	.85	6SA7	.50	12BE6	.65
1R5	.50	6AX5	.85	6X7	.50	12BH7	.65
1T4	.50	6BA6	.45	6SK7	.80	12BY7	.37
1U5	.45	6BC5	.40	6SL7	.35	12SA7	.64
1X2	.85	6BE6	.45	6SN7	.55	12SK7	.45
3V4	.75	6BG6	1.15	6SQ7	.55	12SN7	.56
5U4	.45	6BK7A	1.11	6T4	1.15	12SQ7	.50
5V4	.60	6L7	.90	6T8	.40	6083	.69
5Y3	.65	6BN6	1.19	6V6	.55	25L6	.42
6AC7	.65	6BQ6	1.90	6W4	.35	25W4	.45
6AG5	.45	6CA7A	1.39	6X8	.40	6083	.69
6AK5	.60	6C4	.35	6X5	.45	35W4	.50
6AL5	.40	6C6	.50	6X8	.85	35Z5	.45
6AQ5	.45	6DG6	1.08	6T8	.40	6083	.69
6AT6	.40	6CF6	1.25	12AT7	.65	50C5	.52
6AU4	.95	6CL6	1.65	12AU6	.41	50L6	.35
6AU5	.65	6C9	.40	12AX4	.50	79	.85
6AU6	.45	6J6	.45	12AX4	.68	83V	1.22

FAMOUS BRAND PHONO CARTRIDGES

Original Boxed, Money Back Gtd. RPK050A .001 & .003 (SS).....\$6.75 RPK052A Golden Treasure (DS).....\$15.25 RPK053A Golden Treasure (DD).....\$28.00 Replacement Needles "TETRAD" Diamond RPJ013A Dual (DS) .001 & .003 "TETRAD".....\$10.98 RPJ01D or RPJ03D Single (D) "TETRAD".....\$8.98 RPJ01S or RPJ03S Single (S).....\$1.65 RPJ003 or RPJ004 Single (D) "TETRAD".....\$8.98 MG or 78 Single (D) "TETRAD" if any make.....\$8.98

NEW IMPROVED "TAB" HI-FI SPEAKERS

With Inbuilt Network Ticonal Alnico 5 Plus Magnet, 4 to 8 Ohms 15" TRIAX, 25 Watt/20-20,000 Cycles. MODEL F15H3X.....\$36 12" TRIAX, 20 Watt/40-20,000 Cycles.....\$27 MODEL F12H3X.....\$27 12" COAX, 20 Watt/35-18,000 Cycles. MODEL F12H2X.....\$22

FINEST HI-FI RECORDING TAPE

1200 Ft.—7" Reel \$1.45 Lots Money Back Gtd. of 12 Highest quality controlled plastic base tape made by new Ferro-Sheen process. Precision coated & slit Gtd. Constant output. Splice Free. Freq. 7 1/2 IPS 40-15KC Oxide Wnd In. 3 FOR \$1.50 EACH; SINGLY @ \$1.59 EA.

NEW 1st quality "MYLAR" 2400 Ft.—7" REEL Ferro-sheen processed @ \$4.49, 3/\$12; 12 for \$45.

"TAB"

TERMS: Money Back Gtd (cost of mfg only) 5% min order F.O.B. N.Y.C. Add shpg charges or for C.O.D. 25% Dep. Tubes std. via R-Exp. only. Prices shown subject to change.

111R LIBERTY ST., N. Y. 6R3, N. Y., RE 2-6245

INDEX OF Advertisers

MARCH 1957

While every precaution is taken to insure accuracy, we cannot guarantee against the possibility of an occasional change or omission in the preparation of this index.

ADVERTISER	PAGE	ADVERTISER	PAGE
Aero Products Company.....	90	Lafayette Radio Corp.....	150, 151
Advance Electronics Company.....	170	Lampkin Laboratories, Inc.....	120
Airex Radio Corp.....	162	Lektron Specialties.....	163
Allied Radio Corp.....	9, 30, 115, 127, 128, 129, 130, 131, 132, 133, 147		
Altec Lansing Corporation.....	91		
American Elite, Inc.....	98, 136	McGee Radio Company.....	142, 143
Amphenol Electronics.....	110	McGraw-Hill Book Company.....	166
Anchor Products Co.....	108	M. R. Company, The.....	162
Antenna Specialists, Inc.....	148	Mallory & Co., Inc., P. R.....	Fourth Cover
Argos Products Company.....	147	Milwaukee School of Engineering.....	160
Arkay Kits, Inc.....	101	Moss Electronic Distributing Co.....	134, 135
Arrow Sales, Inc.....	154, 158		
Ashe Radio Company, Walter.....	28	Natco Aviation.....	168
Association of Master Technicians, Inc.....	168	National Radio Institute.....	3, 7
Audel Publishers.....	169	National Schools.....	17, 163
		Neshaminy Electronics Corp.....	95
B & K Manufacturing Co.....	14	Newark Electric Company.....	165
Baltimore Technical Institute.....	168	North American Phillips Co., Inc.....	16
Barry Electronics Corp.....	171	Nortronics.....	168
Bendix Radio.....	156	Nova-Tech.....	126
Blonder-Tongue Laboratories, Inc.....	103		
Burstein-Applebee Co.....	137	Oelrich Publications.....	137
		Olson Radio Warehouse.....	153
CBS-Hytron.....	19	Pampa Electronics Corp.....	96
Candler System Co.....	154	Peak Electronics Company.....	168
Capital Electronics.....	163	Phaotron Instrument & Electronic Co.....	111
Capitol Radio Engineering Institute.....	21	Pilot Radio Corp.....	94
Champion DeArment Tool Co.....	124	Precision Electronics.....	89
Channel Master Corp.....	31	Progressive "Edu-Kits," Inc.....	169
Chicago Standard Transformer Corporation.....	139		
Cleveland Institute of Radio-Electronics.....	15	Quality Electronics.....	166
Columbia Electronics.....	122		
Coyne Electrical School.....	138, 156		
Delco Radio.....	29	R.C.A. Institutes, Inc.....	13
DeVry Technical Institute.....	5	Radio Corporation of America.....	6, 23, 86, 107
Duotone Company, The.....	92	RW Electronics.....	167
Dressner.....	154	Radiart Corp., The.....	22
Dyna Company.....	97, 101	Radio-Television Training Association.....	99, 100
Dynamic Electronics-New York, Inc.....	114	Rad Tel Tube Co.....	164
		Rauland-Borg.....	104
		Raytheon Manufacturing Company.....	Second Cover
Editors & Engineers, Ltd.....	161	Recoton Corporation.....	97
Electro-Craft Co.....	170	Reeves Soundcraft Corp.....	11
Electronic Chemical Corp.....	139	Rek-O-Kut Company, Inc.....	88
Electronic Instrument Co., Inc.....	33, 34	Rex Radio Supply.....	156
Electro-Sonic Laboratories, Inc.....	104	Rinehart & Co., Inc.....	117, 140, 158, 164
Electro-Voice.....	27	Rockbar Corporation.....	20
Fair Radio Sales.....	149	Sams & Co., Inc., Howard W.....	26, 144
Fisher Radio Corporation.....	87	Sarkes-Tarzian, Inc.....	125
		Scott-Mitchell.....	122
		Service Instrument Co.....	114
G & G Radio Supply Co.....	141	Shure Brothers, Inc.....	32, 109
Gardner Electronics Co.....	96	Sonotone Corporation.....	18
Garfield Company, Oliver.....	170	Stan-Burn Radio & Electronics Co.....	154
General Electric.....	93, 102	Standard Electrical Products.....	108
Goodheart, R. E.....	137	Standard Line.....	145
Granco Products.....	170	Stanley Electronics Corp.....	161
Grantham School.....	120	Stevens Walden, Inc.....	106
Greenlee Tool Co.....	138		
Hallcrafters.....	10	"TAB" Technical Appliance Corporation.....	172
Harjo Sales Co.....	154	Technical Appliance Corporation.....	121
Harvey Radio Co., Inc.....	138	Telemarine Communication Co.....	159
Head Engineering College.....	122	Tele-Test Instrument Corporation.....	114
Heath Company.....	72, 73, 74, 75, 76, 77, 78, 79, 80, 81, 82, 83, 84, 85	Texas Crystals.....	166
Henshaw Radio Supply.....	154	Tran-Kit Electronics Co.....	104
Hershel Radio Co.....	162	Transvision, Inc.....	115
Hickok Electrical Instrument Company, The.....	106	Triad Transformer.....	115
Hi-Lo TV Antenna Corp.....	105	Triplet Electrical Instrument Corp. Third Cover.....	167
Hughes Research & Development Laboratories.....	155	Tri-State College.....	167
		Tube Mart.....	169
Indiana Technical College.....	116	Uncle Sams Recordings.....	168
Instructograph Company.....	170	United Catalogue Publishers, Inc.....	152
International Business Machines Corp.....	24, 25	United Radio Corp.....	154
International Resistance Co.....	112, 113	University Loudspeakers.....	12
Johnson Company, E. F.....	93	V. S. I. Television School.....	137
		Valparaiso Technical Institute.....	158
Karlson Associates, Inc.....	90	Video Electric Co.....	165
Kester Solder Company.....	108		
Klein & Sons, Mathias.....	8	Ward Products Corporation.....	71
Kopelove Electronics Co.....	167	Warren Industrial Co.....	126
		World Radio Laboratories.....	116
		Wuerth Tube-Saver Corp.....	106
		Zytron Tube Company.....	116

performance matched
test equipment

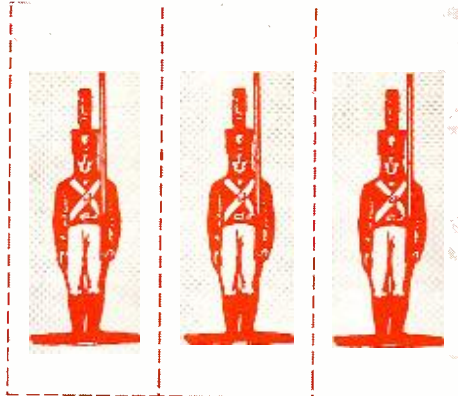

basic

fundamental

essential

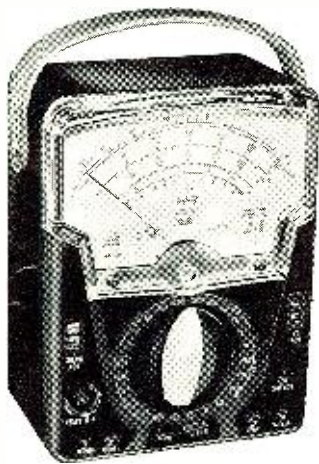

MODEL 631
VOM-VTVM

two in one tester for 100% service—VOM covers 90% of your usage, battery operated VTVM available for the other 10% when you need it.. **\$64.50**

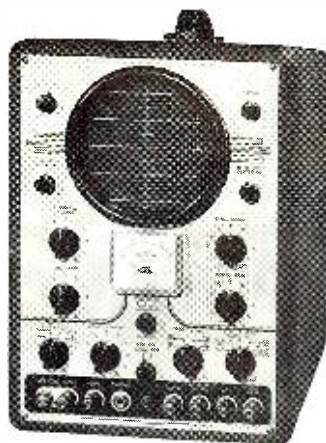

MODEL 3441-A

three in one scope—oscilloscope, peak-to-peak meter, audio oscillator—essential for more than 50% of your Black and White Servicing—all Color Servicing. 10 mv sensitivity. 4.5 mc bandwidth. **\$249.50**

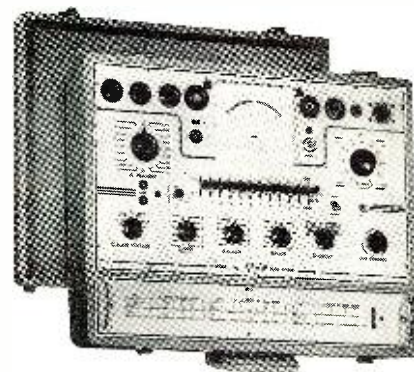

MODEL 3423

four in one—mutual conductance tube tester, transistor tester, germanium diode tester, selenium rectifier tester—checks for accuracy as circuit demands depending on the tolerance of the circuit. The patented circuit for the tube testing employs actual signal (4KC) for grid and DC bias voltage making it independent of line voltage hum. It also has a complete coverage of all tube types—six plate voltages (including 0-10 variable). Micromhos scales read 0-1,800, 0-6,000, 0-18,000 and 0-36,000. Leakage measured directly on meter 0-10 megohms. **\$199.50**



BURTON BROWNE ADVERTISING

TRIPOLET

These three units provide the ideal basis for the complete servicemen's test setup. Don't make a mistake! Before you buy, ask your parts distributor to demonstrate these and many other Triplet units. Buy performance matched equipment!

TRIPOLET ELECTRICAL INSTRUMENT COMPANY • BLUFFTON, OHIO



631
Combination
V-O-M—VTVM



630-NA
For Best Testing
Around the Lab,
Production Line
or Bench

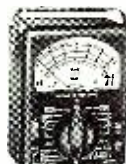

630
The Popular
All-Purpose
V-O-M



630-A
A Good Lab and
Production Line
V-O-M



310
The Smallest
Complete V-O-M
with Switch



630-T
For Telephone
Service



666-HH
Medium Size
for
Field Testing



625-NA
The First V-O-M
with 10,000
Ohms/Volt AC



666-R
Medium Size
with
630 Features

... another
MALLORY
service-engineered
product

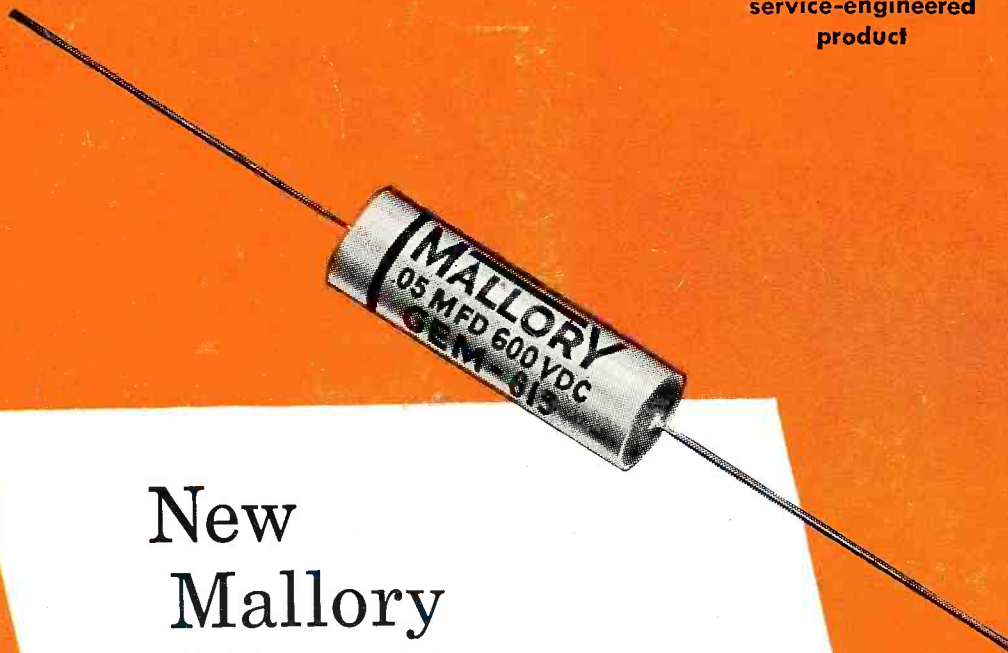

New Mallory "Gems" pace setters in paper capacitors

Next time you replace paper tubulars, make sure you use these new Mallory capacitors. They give you a lot of extra value features—without extra cost.

Soldering iron heat can't loosen leads. Wires are permanently attached in the plastic end seal... can't work loose from heating or vibration.

Moistureproof construction, using a protective case of high grade mica-filled bakelite, ends worries about premature shorts due to high humidity.

True center construction protects the foil element from deformation during assembly... assures uniform quality in each capacitor.

Get your stock now, from your local Mallory distributor. Ask for Mallory "Gems"—you'll agree they're a gem of a capacitor!



- Capacitors • Vibrators • Resistors • Controls • Switches
- Rectifiers • Power Supplies • Filters • Mercury Batteries